

mipick MP

Pick-to-Light System

User Manual



Index

1	GENERAL	4
2	SYSTEM OVERVIEW	5
3	COMPONENTS	6
3.1	Distribution Unit	6
3.1.1	Distribution Unit for Ethernet TCP/IP	6
3.1.2	Distribution Unit for Profibus DP	9
3.2	Pick Displays	12
4	WIRING	15
4.1	Distribution Unit	16
4.2	Display Shaft	17
4.3	mipick	17
4.4	Bus Termination	17
5	ETHERNET	18
5.1	Configuration of the Ethernet Interface	18
5.2	Ethernet Communication	20
5.2.1	Send Commands	21
5.2.2	Receive Status Messages	22

6	PROFIBUS DP	23
6.1	Configuration of the Profibus Interface	23
6.1.1	GSD File	23
6.1.2	Configuration Data	23
6.1.3	User Parameter Data	24
6.1.4	Diagnosis Data	24
6.2	DP Communication	25
6.2.1	Transmit Commands	26
6.2.2	Receive Status Messages	27
7	FRAME STRUCTURE	29
7.1	Structure of Commands	29
7.2	Structure of Status Messages	29
7.2.1	Command Confirmation	29
7.2.2	Event Message	29
7.2.3	Bus Member Message	30
7.3	Standard Control Command	31
7.4	Additional Commands	33
8	DISPLAYABLE CHARACTERS	35
9	DECLARATION OF CONFORMITY	36
10	VERSIONS OVERVIEW	37

1 General

The light-controlled picking and assembly with small parts warehouses and manual assembly workstations reduces the error rate, shortens the part search and simplifies training. The limited space is an unsolvable task for a lot of pick-to-light systems. With development of the "mipick MP", microSYST has found a solution for exactly this problem.

"mipick MP" stands for assembly and installation with little effort thanks to simplified wiring and newly developed software-controlled programming.

The channel height of this display is only 30 mm, width 80 mm - space saving and efficient! If the displays are mounted without space, box widths of only 80 mm can be realised!

The display is equipped with two LED indicators (red + multi-colored), a metal confirmation push button and LED directional arrows. A two-digit 7-segment LED display with 14 mm digit height serves for a pleasant readability of values. Furthermore there's a membrane keypad for possible value corrections.

The communication with the displays happens via an RS485 interface, the superior system is controlled via Ethernet and ensures a fast and reliable data transfer.

We are pleased to offer this display also as part of a complete system, with individual assembly workstation and software, which is perfectly tailored to your application.

2 System Overview

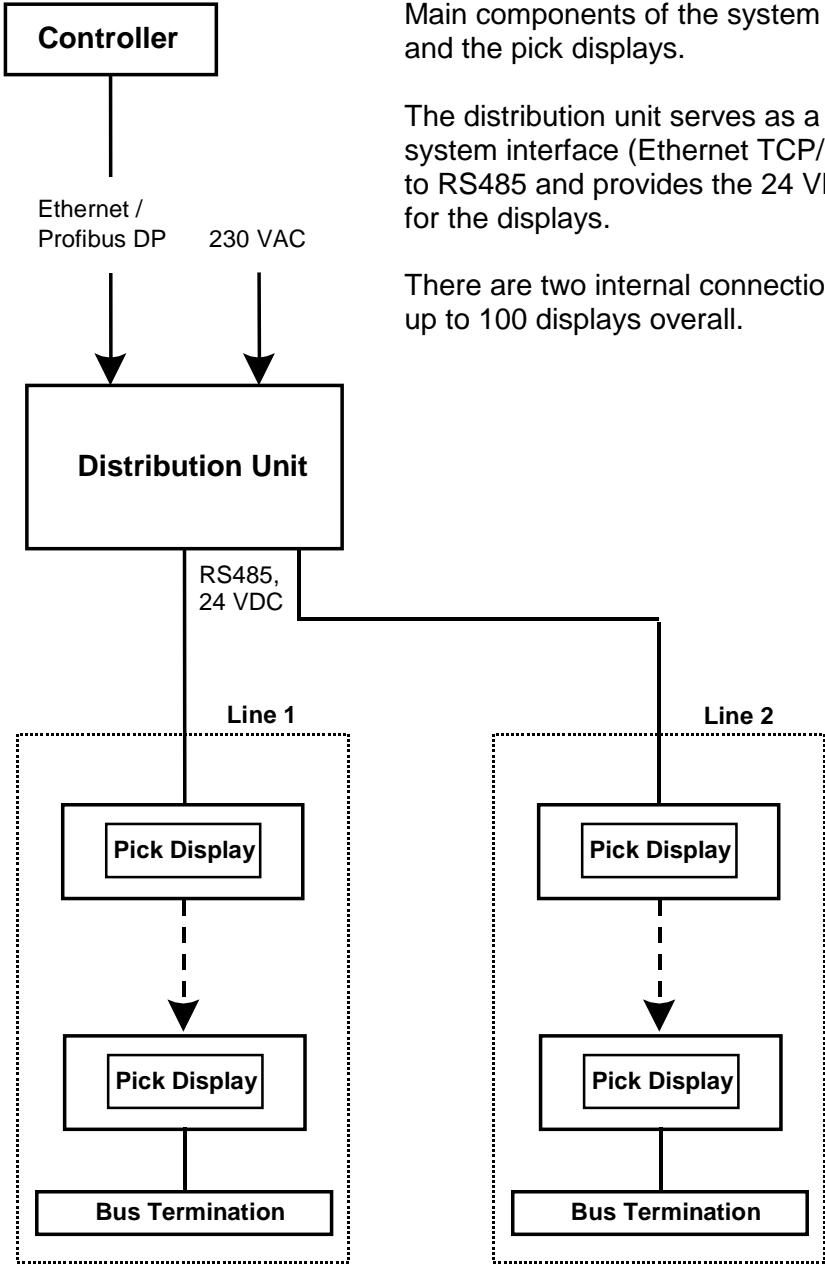

Main components of the system are distribution unit and the pick displays.

The distribution unit serves as a converter from the system interface (Ethernet TCP/IP or Profibus DP) to RS485 and provides the 24 VDC supply power for the displays.

There are two internal connections that can operate up to 100 displays overall.

3 Components

3.1 Distribution Unit

3.1.1 Distribution Unit for Ethernet TCP/IP

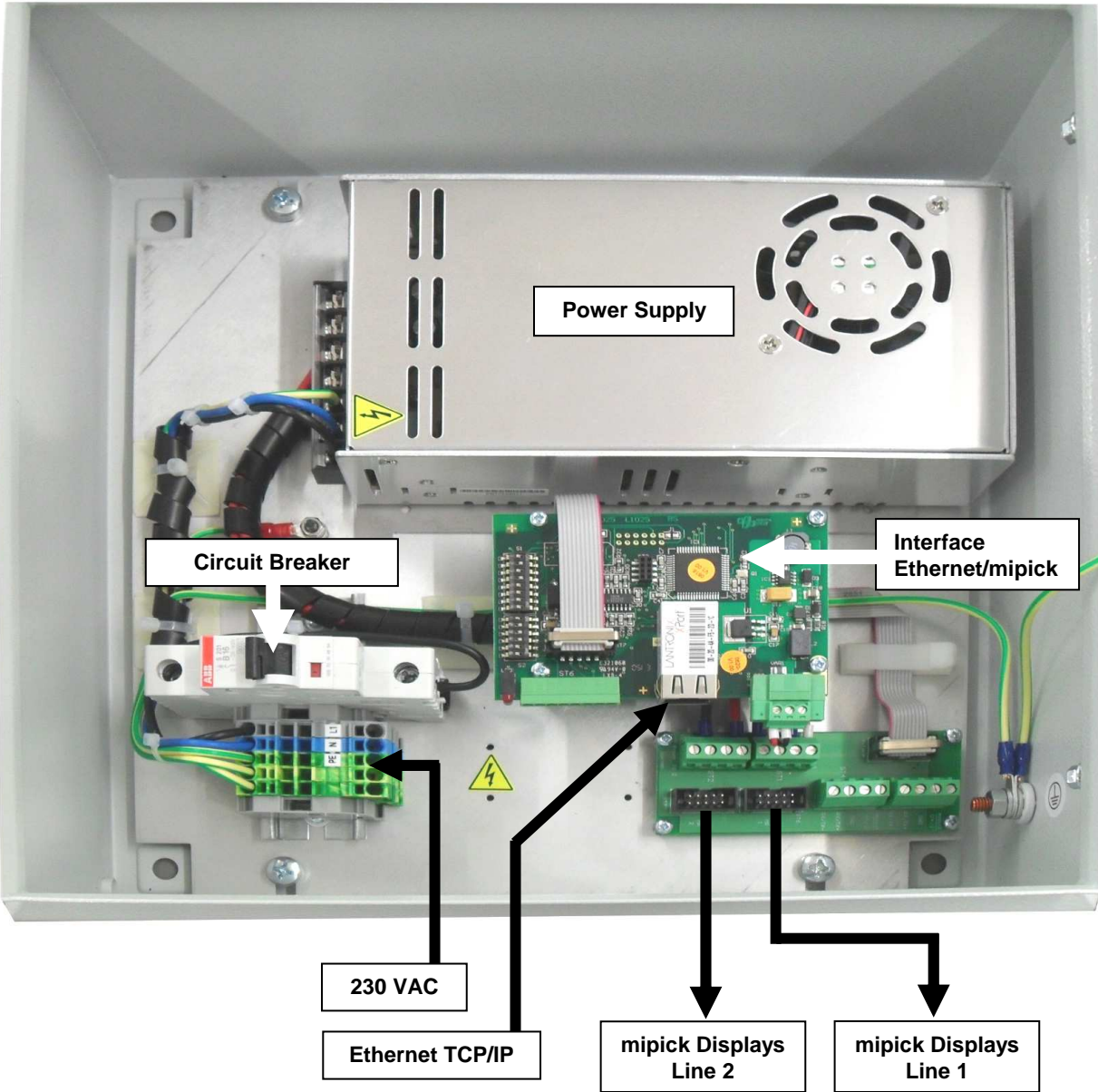

mipick MP User's Manual

Interface Ethernet / mipick

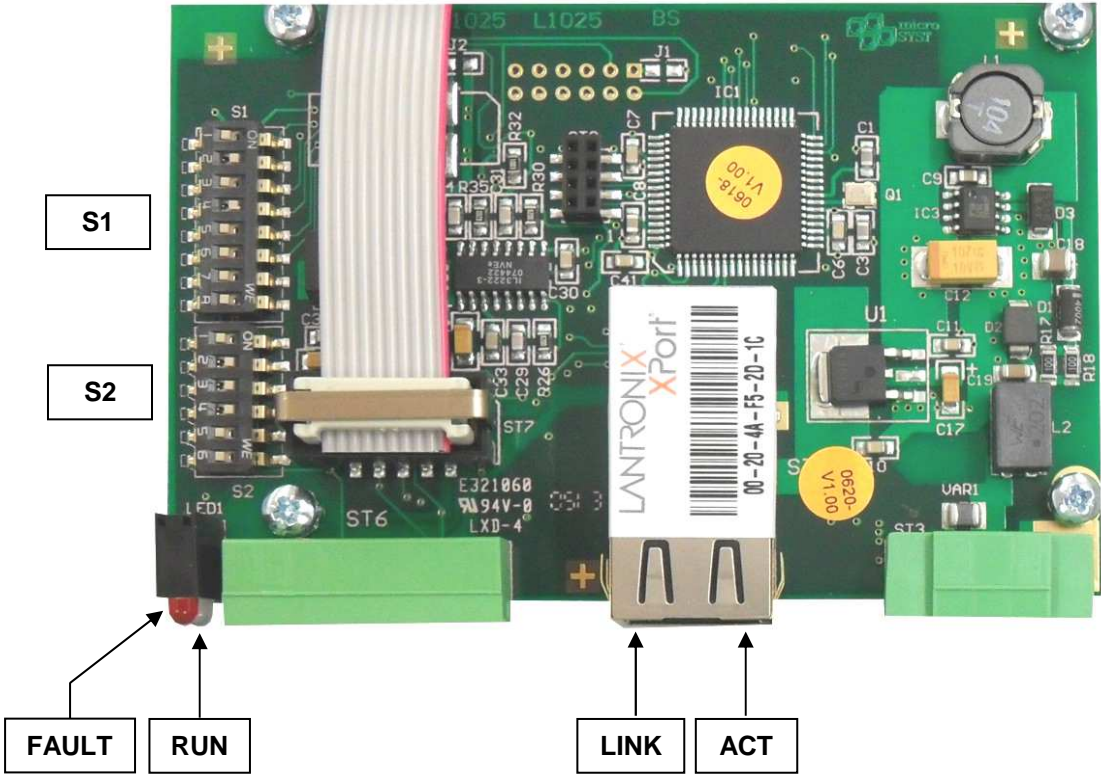

LED	Status	Meaning
ACT	Green	Full-Duplex
	Yellow	Half-Duplex
	Off	No network activity
LINK	Green	Physical network connection with 100 MBaud
	Yellow	Physical network connection with 10 MBaud
	Off	No physical network connection
FAULT	Red	No active TCP/IP connection
	Off	Active TCP/IP connection
RUN	Green	No data traffic at the serial interface
	Blinking	Data traffic at the serial interface

Positions marked with “■” are fixed and must not be changed!
 Bold-framed positions are the default.

Switch S1: Options		
DIP	ON	OFF
1	Test mode: Every display shows its own RS485 address. There should be no Ethernet communication at the same time!	Normal mode
2	Use 128 RS485 addresses (0...127) for the RS485 cycle, enable the bus member message C2	Use 64 RS485 addresses (0...63) for the RS485 cycle, bus member message C2 locked
3		■
4	Send bus member messages (C1, C2) automatically at a change (and after the Ethernet connection has been established)	Send bus member messages (C1, C2) only at a query (C0, C1 or C2)
5		■
6		■
7		■
8		■

Switch S2: RS485 Bus Termination		
DIP	ON	OFF
1		■
2	■	
3	■	
4	■	
5	Bus termination is set	no bus termination
6		

The bus termination must be set, if the interface is connected at the first position within the RS485 bus.

mipick MP User's Manual

3.1.2 Distribution Unit for Profibus DP

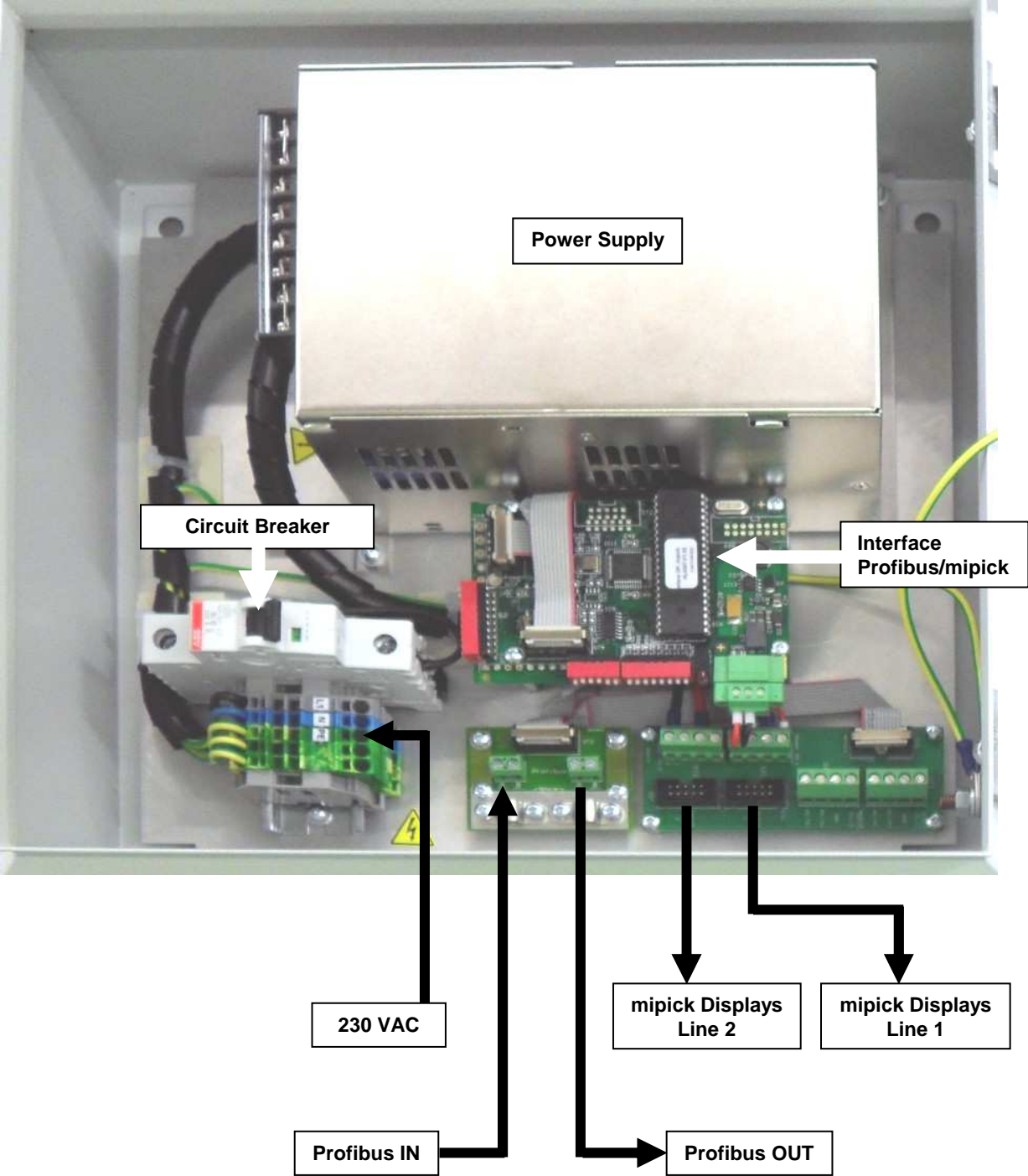

Interface Profibus / mipick

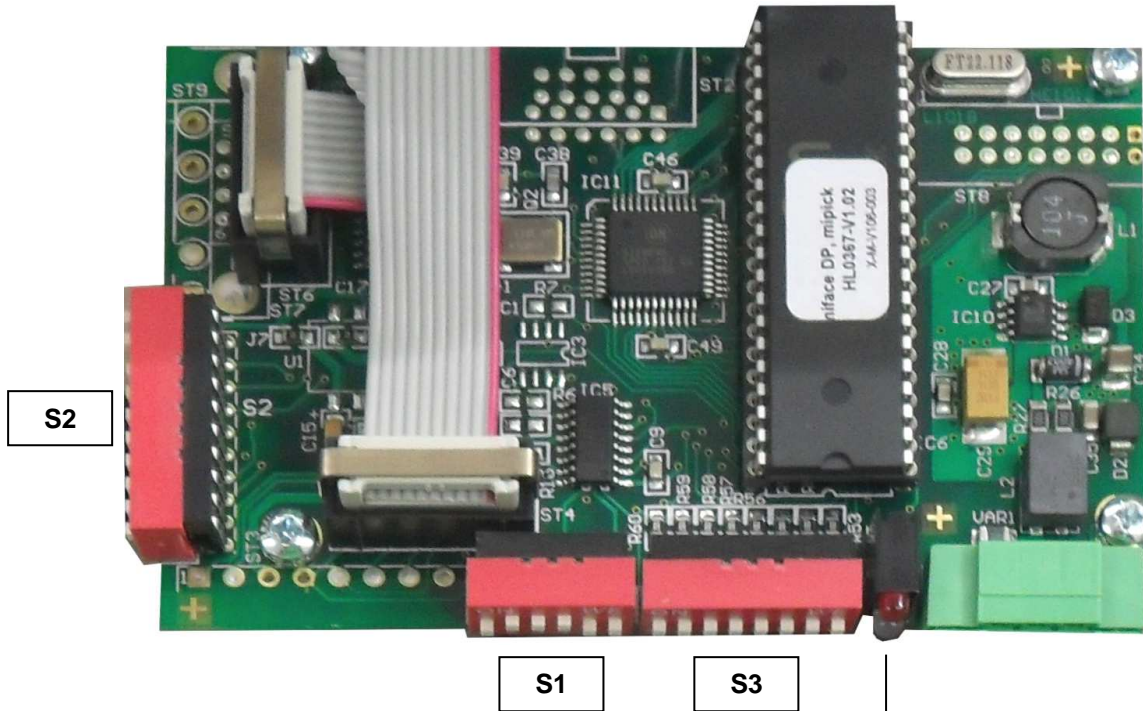

LED	Status	Meaning
red (FAULT)	off	Profibus DP connection established
	on	no cyclical Profibus DP communication or RAM error (if green LED is off)
	blinking	no RS485 response (within the last 500 ms) or RS485 communication stopped, because a new status message is existent and the former status message has not been confirmed (DP-OUT-QBS must be set to DP-IN-TBS)
green (RUN)	off	Controller is not working (hardware error)
	on	Controller is working
	short off (flickering)	Profibus DP toggle byte was changed (command or status message transmitted)

Positions marked with “■” are fixed and must not be changed!
 Bold-framed positions are the default.

Switch S1: RS485 Bus Termination		
DIP	ON	OFF
1		■
2	■	
3	■	
4	■	
5	Bus termination is set	no bus termination
6		

Bus termination must be set, if the interface is on first position within the RS485 bus.

Switch S2: DP Address, DP Bus Termination	
DIP	Function
1	DP address Bit 2 ⁰ (ON = 1)
2	DP address Bit 2 ¹ (ON = 2)
3	DP address Bit 2 ² (ON = 4)
4	DP address Bit 2 ³ (ON = 8)
5	DP address Bit 2 ⁴ (ON = 16)
6	DP address Bit 2 ⁵ (ON = 32)
7	DP address Bit 2 ⁶ (ON = 64)
8	reserved (= OFF ■)
9	both ON: Profibus bus termination set
10	both OFF: no Profibus bus termination

Only DP addresses 0 to 126 are permitted.

Switch S3: Options		
DIP	ON	OFF
1	Test mode: Every display shows its own RS485 address. There should not be Profibus communication at the same time!	Normal mode
2	Use 128 RS485 addresses (0...127) for the RS485 cycle, enable the bus member message C2	Use 64 RS485 addresses (0...63) for the RS485 cycle, bus member message C2 locked
3	Transmit every status message immediately (separately) to the DP master (-> easier handling but slower)	Accumulate status messages until DP-IN buffer is full or the current polling cycle is finished.
4	Send bus member messages (C1, C2) automatically at a change (and after power-up and every restart of DP communication)	Send bus member messages (C1, C2) only at a query (C0, C1 or C2)
5		■
6		■
7		■
8		■

3.2 Pick Displays

Technical Data

Display type:	7 segment LED
Character height:	14 mm
Digits:	2
Display colour:	rot
Operating voltage:	24 VDC +/-20 %
Current consumption:	32 mA at 24 V (0,77 W)
Data input:	RS485 with 115 kBaud
Display:	see chapter "Displayable Characters"
Addresses:	0...99
Keypad:	membrane keypad with 2 buttons
Safety push button:	metal design, mechanical service life: 1.000.000 cycles, diameter 12 mm, separately replaceable
Signal lamp:	1 x LED red, 1 x LED multicoloured, LED diameter: 8 mm
Housing:	aluminium, anodised
Dimensions:	80 x 30 mm (w x h)
Shaft depth including display:	30 mm
Housing colour:	natural with grey foil
Mounting:	snap-on mounting
Protection:	front panel IP40
Operating temperature:	0...+50°C
Storage temperature:	-25...+70°C

Addressing

The address setting is done manually with buttons or automatically with the help of the software "miprogram".

Addressing with buttons

This is preferred if only single displays have to be programmed (for example if any display shall be replaced). For this, the pick display is only connected with power but not to the RS485 bus.

Addressing with software

This is the perfect method to program complete picking systems. All displays on the RS485 sub bus can be programmed in a simple way.

Systems with Ethernet are addressed via the Ethernet interface.

Systems with Profibus are addressed via RS485. The RS485 bus between distribution unit and the display is interrupted and connected with the configuration PC via an USB/RS485 converter.

Addressing with buttons

- Press confirmation button and "+" button at the same time.
- Connect the supply power.
- Set the address with the buttons "+" and "-".
- Press confirmation button.

Addressing with software

- Select the interface and press button “Verbindung herstellen” (= establish connection).

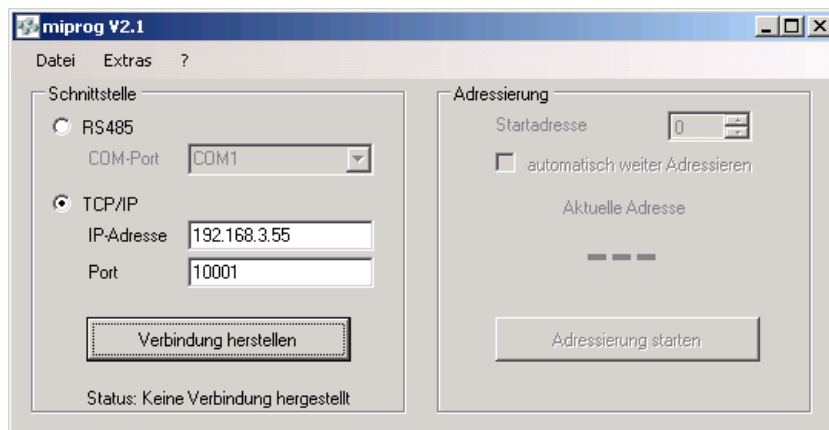

- Select the start address of the first pick display and (if you have several displays) the option “automatisch weiter Adressieren” (=automatically continue with addressing).
- After pressing button “Adressierung starten” (= start addressing), the current RS485 address, which shall be assigned, is shown.

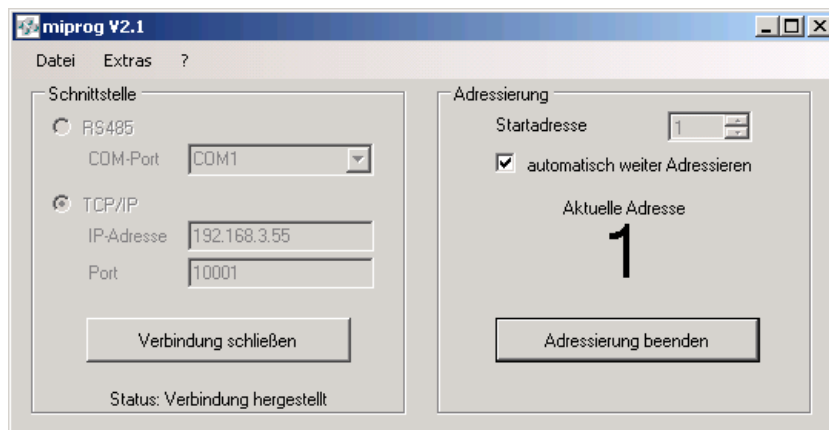

- Now, the LEDs of all displays are blinking and the current address is shown everywhere. Press the button of that display, which shall obtain this address.
- The current address is increased in the software. Continue, until all displays of the bus are addressed.

Stop the programming with button “Adressierung beenden” (= stop addressing).

mipick MP User's Manual

4 Wiring

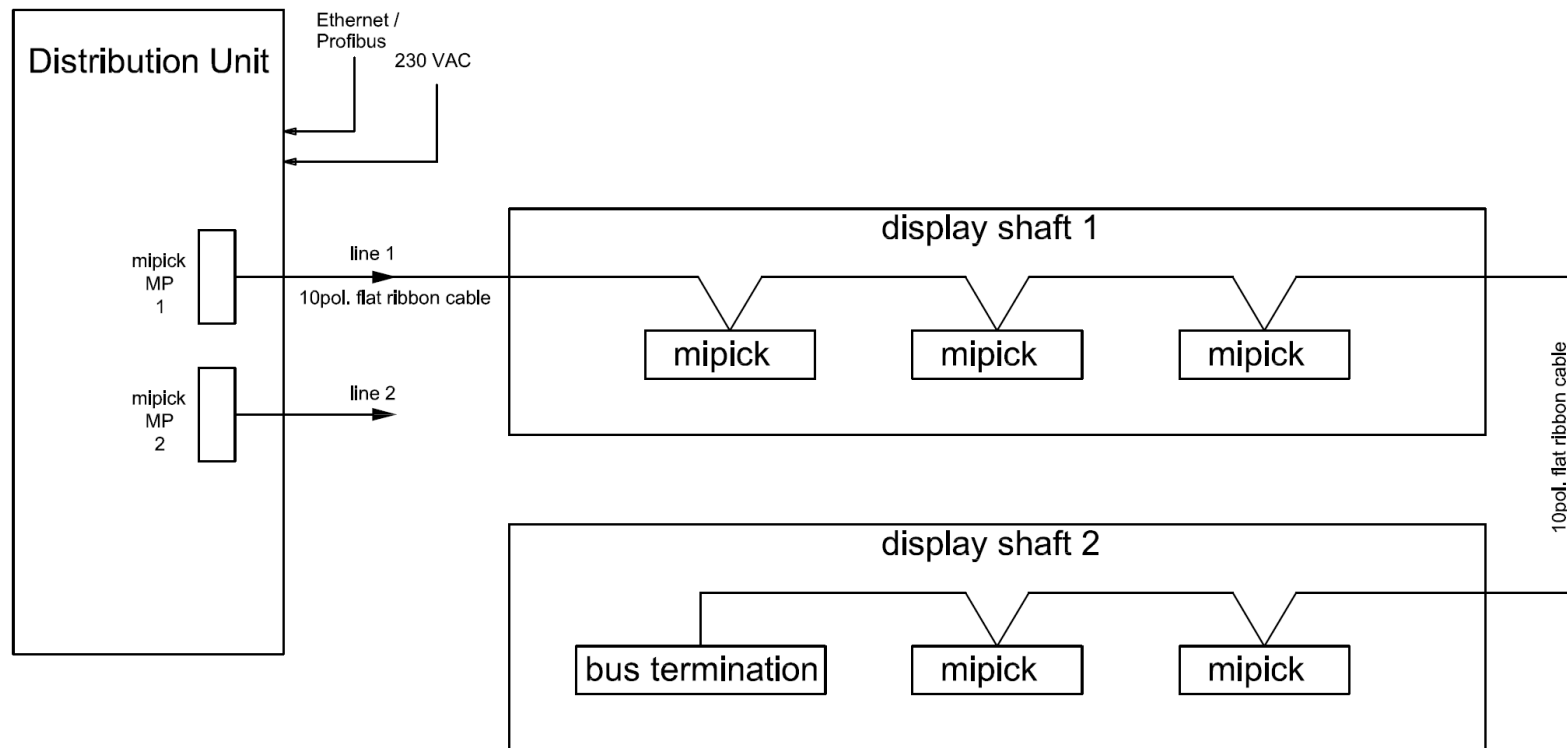

mipick MP User's Manual

4.1 Distribution Unit

Supply power (230 VAC)

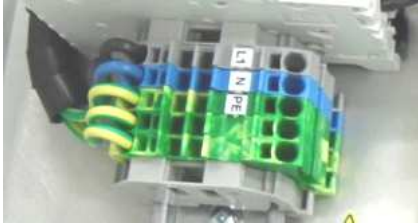

System Interface

Ethernet:



Profibus DP

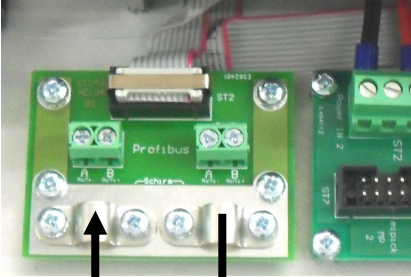

Display Interface

Supply of RS485 bus and power for both display lines.

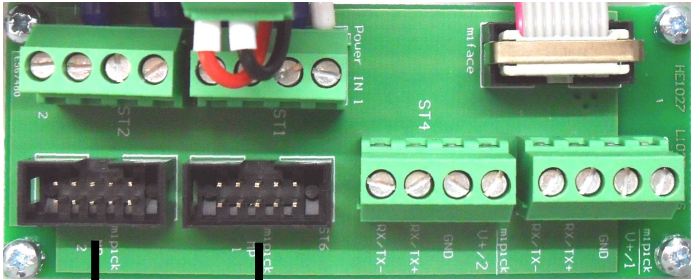

line 2 line 1
to the display shaft

mipick MP User's Manual

4.2 Display Shaft

The lateral shaft cover has a gland. A slotted protective tube does the insertion of the flat ribbon cable into the shaft.



4.3 mipick

from distribution unit



4.4 Bus Termination

The termination is plugged after the last display of the line.

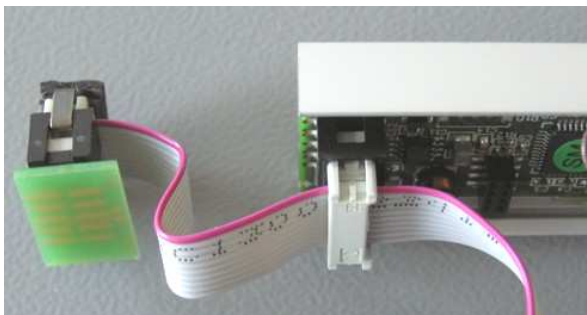

5 Ethernet

5.1 Configuration of the Ethernet Interface

The distribution unit is preset with the following network settings:

IP address: 192.168.4.200
Net mask: 255.255.255.0
Port: 10001

To change these parameters, proceed as follows:

Advice for Windows 7 users:

The Telnet client must be activated:

*Start -> Control Panel -> Programs -> Turn Windows features on or off
-> Telnet Client*

- Switch on the supply power and connect the distribution unit to the network hub with an RJ45 cable (1:1 cable) or directly to a PC (crosslink cable).
- Start the "MS DOS entry prompt" at your Windows PC.
With Windows 7 you must have extended rights:
Start -> All Programs -> Accessories -> double-click at Command Prompt -> Run as Administrator
- Enter the desired IP address for the device to the ARP table:
ARP -S XXX.XXX.XXX.XXX xx-xx-xx-xx-xx-xx <CR>

XXX.XXX.XXX.XXX : desired IP address
xx-xx-xx-xx-xx-xx : Ethernet MAC address of the interface
(see label at the RJ45 socket)

- Establish a Telnet connection to port 1:
`TELNET XXX.XXX.XXX.XXX 1 <CR>`

This connection will fail (disconnect within 3 seconds). However, the IP address of the interface is temporarily changed.
Close the Telnet window after acknowledging the error message.

- Establish a Telnet connection to port 9999:
`TELNET XXX.XXX.XXX.XXX 9999 <CR>`

After the connection has been established, immediately press the enter key (within 5 seconds) in order to enter the setup mode.

- **Please do never select “7” (Defaults).
Those settings do not match for the system.**
- Enter “0” (Server).
- Enter the desired IP address and press the enter key.
- Repeatedly press the enter key until
”Netmask: Number of Bits for Host Part (...)“ appears.
Enter here the number of free bits for the IP address,
f.e. “8” for the netmask 255.255.255.0
(=11111111.11111111.11111111.00000000) or
“11” for the netmask 255.255.248.0
(=11111111.11111111.11111000.00000000) and press the enter key.
- Repeatedly press the enter key until “Your choice?” appears.
- Press “9” to save all settings (-> the Telnet connection is interrupted).

Configuration of the Ethernet interface is now complete.
Now, the control frame can be transmitted via the selected IP address (TCP/IP connection via port 10001).

5.2 Ethernet Communication

The Ethernet interface of the distribution unit serves for the communication between a controller (for example PC or PLC) and the mipick devices.

“**Commands**” are sent from the controller to the interface via Ethernet and then forwarded to the particular mipick devices.

“**Status messages**” are sent from the mipick devices to the interface via RS485 and then forwarded to the controller via Ethernet.

The Ethernet interface acts as bus master at RS485 side.

As long as no “commands” are available, the bus-sharing units (mipick devices) are polled cyclically (order: address 0 to 63, 0 to 63, ... or 0 to 127, 0 to 127,...). If there happens an event at this (for example “button was pressed”), the mipick replies correspondingly and then a related “status message” is sent via Ethernet.

If there is a “command” available for a certain RS485 address, it is sent to the bus-sharing unit instead of the polling frame. The response of the mipick device is acknowledged via the Ethernet.

If there is identified that a new bus-sharing unit was added or a former existing bus sharing unit does not respond (correctly), a special frame is received via the Ethernet. The controller can explicitly request this “bus member message” in order to get the current bus status.

Commands and status messages are described in chapter “Frame Structure”. They have the following build-up:

A	L	D
Address of the pick display	Length of the data	Data
1 byte	1 byte	n bytes

5.2.1 Send Commands

The transmission of the “commands” happens from the controller to the Ethernet interface and then via a RS485 bus to the concerning mipick devices.

With every TCP/IP frame, one ore several commands (without gap) are transmitted to the Ethernet interface. Every command has the structure “address”, “length” and “data”.

A new command must only then be sent to a certain address, if the last command has been answered or at least approximately 1 second has elapsed. Then, the bus member has not answered or not answered correctly.

After a “broadcast command” you have to wait for the command confirmations first (one per existing bus member) before you send a new command. 1 second is enough.

Please note: If you wait for several command confirmations, they must not necessarily arrive in the same order like the corresponding commands have been sent. It's possible that an “event message” or “bus member message” intervenes between the single command confirmation frames!

Example:

The value “12” shall be shown at display with address 4:

Send command via TCP/IP (in hexadecimal presentation):

```
04 08 80 20 20 31 32 00 00 00
```

```
(address = 4, length = 8 bytes, data = 80 20 20 31 32 00 00 00)
```

5.2.2 Receive Status Messages

There are three types of status messages:

1. Command confirmations (= command responses)
2. Event messages (for example "button was pressed")
3. Bus member messages ("device removed or added")

Status messages are sent to the controller with a TCP/IP frame. Every TCP/IP frame can contain one or more status messages (without gap). Every status message has the structure "address", "length" and "data".

Examples:

a) Command confirmation to the command above:

Receive the command confirmation via TCP/IP (in HEX representation):

```
04 01 80
```

(address = 4, length = 1, data = 80)

b) Button of display 4 pressed:

```
04 03 00 81 0C
```

c) Button of display 4 was released:

```
04 03 00 80 0C
```

Note: Only one status message is transferred in the examples above but if there are several status messages, they are received simultaneously.

6 Profibus DP

6.1 Configuration of the Profibus Interface

6.1.1 GSD File

The device database file „micr05D0“, which is part of the delivery, is used for the integration of the Profibus DP interface (DP slave) to the Profibus. Among other things, it contains the necessary identifiers for the configuration of the input- output data widths (see next chapters).

6.1.2 Configuration Data

With the configuration, the user has the possibility to set an individual data width of the cyclic data exchange. Therefore, the following identifiers (max. 30) must be selected in any desired order.

The DP master transmits the identifier to the DP slave before it starts the cyclic data exchange.

Byte no.	Data identifier	Number of bytes	Function / Description
x	0x10	1	Input Data
x	0x11	2	Input Data
	:	:	
x	0x1F	16	Input Data
x	0x20	1	Output Data
x	0x21	2	Output Data
	:	:	
x	0x2F	16	Output Data
x	0x30	1/1	Input-/Output Data (1 byte each)
x	0x31	2/2	Input-/Output Data (2 bytes each)
	:	:	
x	0x3F	16/16	Input-/Output Data (16 bytes each)

The minimum number of input or output bytes is 6 bytes each.

The maximum number of input or output bytes is 200 bytes each, but an overall length of 300 bytes (input + output) must not be exceeded.

⇒ Standard configuration: 0x3F, 16 input-/ output bytes.

6.1.3 User Parameter Data

User parameter data are not utilized by the interface. However, a test is run to determine whether or not the Profibus master transfers user parameter data. If user parameter data are transferred, Profibus initialization is disabled and the slave's parameters must be reconfigured.

Note:

Standard parameters configuration is required and is normally installed by the utilized DP configurators.

6.1.4 Diagnosis Data

The interface does not support any extended diagnosis data. Default diagnosis is utilized.

6.2 DP Communication

The DP master handles the Profibus interface (DP slave) as a standard I/O device. This means, there are DP output data, which are cyclically transmitted to the slave and DP input data, which are cyclically received from the slave.

The structure of the I/O data is like follows:

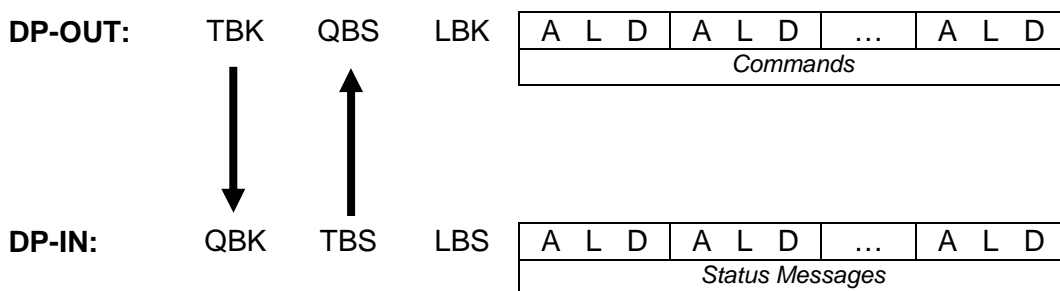

TBK: Toggle byte for the commands

QBK: Confirmation byte for the commands (= TBK after data adoption)

LBK: Length byte for the commands

TBS: Toggle byte for the status messages

QBS: Confirmation byte for the status messages (= TBS after data adoption)

LBS: Length byte for the status messages

A: Address of the pick display

L: Length of the data

D: Data (max. 20 bytes)

Commands and status messages are described in chapter "Frame Structure".

Notes:

After the (new) start of the Profibus DP communication, all DP-OUT bytes and all DP-IN bytes have the value 0.

With the configuration, the number of DP-IN bytes and DP-OUT bytes must be chosen leastwise as large, that the largest possible command or the largest possible status message has enough space. The maximum I/O width must not be exceeded (see chapter „configuration data“).

6.2.1 Transmit Commands

The commands specify, what shall be shown at the displays or how they shall behave. The transmission of the commands happens from the DP master to the Profibus interface (DP slave) and from here via the RS485 bus to the respective displays.

Procedure:

1. In the DP-OUT area "commands", you must enter the command or even several commands (without gap). Every command consists of "address", "length" and "data".
2. The length of all command bytes must be entered at "LBK".
3. Finally, "TBK" is increased by one value.
4. Now, the DP slave starts to evaluate the commands and forward it to the corresponding displays. After this procedure is finished, the "QBK" is set to the value of the previous changed "TBK".
5. If there are further commands available, you can continue with point 1.

Example:

The value "12" shall be shown at display 4:

1. Input the command:
 DP-OUT(hex) = 00 XX 00 04 08 80 20 20 31 32 00 00 00
2. Set "LBK":
 DP-OUT(hex) = 00 XX 0A 04 08 80 20 20 31 32 00 00 00
3. Increase "TBK":
 DP-OUT(hex) = 01 XX 0A 04 08 80 20 20 31 32 00 00 00
4. Wait for "QBK":
 DP-IN(hex) = 00 XX XX XX ...
 DP-IN(hex) = 01 XX XX XX ...

6.2.2 Receive Status Messages

There are three types of status messages:

1. Command confirmations (= command responses)
2. Event messages (for example "button has been pressed")
3. Bus member messages ("device has been removed/added")

The status messages must be fetched from the DP master as fast as possible, otherwise the RS485 communication with the displays can slow down or even stop (until the status messages are fetched)!

Procedure:

1. If the "TBS" changes, there are status messages available for pickup.
2. Now, the status messages to be fetched are available in the DP-IN area "status messages" (without gap, overall "LBS" bytes). Every status message consists of "address", "length" and "data".
3. After the status messages have been read out, the DP master must set the "QBS" to the value of "TBS". This should happen as fast as possible (in order not to slow down the RS485 communication).
4. Continue with point 1.

Examples:

a) Command confirmations to the command above:

1. "TBS" changes:

DP-IN(hex) = XX 00 XX XX XX ...



DP-IN(hex) = XX 01 03 04 01 80

2. Read out the status message:

"LBS" = 3

"Address" = 4

"Length" = 1

"Data" = 80_H (command confirmation)

3. Set "QBS" to the value of "TBS":



DP-OUT(hex) = XX 01 XX XX XX ...

b) Button of display 4 was pressed:

1. "TBS" changes:

DP-IN(hex) = XX 01 XX XX XX ...



DP-IN(hex) = XX 02 05 04 03 00 81 0C

2. Read out the status message:

"LBS" = 5

"Address" = 4

"Length" = 3

"Data" = 00_H 81_H 0C_H (event message: button pressed, display value = "12")

3. Set "QBS" to the value of "TBS":



DP-OUT(hex) = XX 02 XX XX XX ...

Note:

In the examples above, only one status message is transmitted at once.

If there are more status messages available, they are transmitted at the same time in order to utilize the available DP-IN bytes as far as possible and accelerate the communication.

If DIP switch S3-3 is in ON position, every status message is reported separately (to simplify the evaluation at the DP master side).

7 Frame Structure

7.1 Structure of Commands

Address	Length	Data			
		Command	1 th Parameter	...	n th Parameter
0...127, 255*	Number of following bytes	for example 80 _H = "control display"			

*Address = 255: broadcast command:

This command is sent to all possible bus addresses (0...63 or 0...127). Only the really existing MIPICKS of the bus, which are supported by the command, evaluate it and respond with a "command confirmation".

7.2 Structure of Status Messages

7.2.1 Command Confirmation

Address	Length	Data	
		Command confirmation	Possible response data
0...127	>= 1	for example 80 _H	

Every command is receipted with a command confirmation. With this, the complete communication cycle from the controller to the MIPICKS and back again is guaranteed. If necessary, response data from the MIPICK is forwarded.

7.2.2 Event Message

Address	Length	Data				
		Event message	Status byte	1 th Parameter	...	n th Parameter
0...127	Number of following bytes	00 _H	Contains (bit-coded) information to the event, that happened	Additional event information if the space of status byte is not enough		

All existing MIPICKs of the RS485 bus (addresses 0 to 63 or 0 to 127) are always polled. If the status byte is unequal to 0 OR at least one additional "parameter byte" is received, an event is available. It is forwarded from the interface to the controller then.

7.2.3 Bus Member Message

If the corresponding DIP switch is in position "ON", the bus member messages are sent automatically ...

- after every change (new bus member identified or not available anymore)
- every restart of the communication = establishing the Profibus connection (after completion of the currently running polling cycle).

		<i>Data</i>			
Address	Length	Bus Member Message	BTN0	...	BTN7
255	9	C1 _H (bus addresses 0...63) C2 _H (bus addresses 64...127, only if 128 ad- dresses are set with DIP switch)	Bus member states of the addresses 0...7 or 64... 71: (bit 0...7) 1 = device available, 0 = device not available	...	Bus member states of the addresses 56...63 or 120...127: Bit 0...7: 1 = device available, 0 = device not available

The bus member messages can be requested by transmitting the following command:

		<i>Data</i>
Address	Length	"Interface Command"
255	1	C1 _H : Request bus member message C1 _H C2 _H : Request bus member message C2 _H (if 128 addresses) C0 _H : Request bus member messages C1 _H and C2 _H (if 128 addresses)

7.3 Standard Control Command

Command (10 bytes):

1	2	3
Address	Length	Command
0...127, 255 = Broadcast	8	80 _H

4	5	6	7
Text of digit 1	Text of digit 2	Value of digit 1	Value of digit 2
ASCII code (20...7F _H)		ASCII code (30...39 _H , 20 _H = space)	
+ Bit 7 = 1, if decimal point is desired			

8	9
Options 1	Options 2
Bit 0=0: LED 1 (on the top) off =1: LED 1 (on the top) on* Bit 1=1: LED 1 slow blinking Bit 2=1: LED 1 fast blinking Bit 5-3: 000 = LED 2 (on the bottom) off 001 = blue* 010 = green* 100 = red* 110 = yellow* 011 = cyan* 101 = magenta* 111 = white* Bit 6=1: LED 2 slow blinking Bit 7=1: LED 2 fast blinking	Bit 0=1: Arrow "up" on Bit 1=1: Arrow "down" on Bit 2=1: Display slow blinking Bit 3=1: Display fast blinking Bit 4=1: Delete LEDs automatically, if at least one of the two inputs is set Bit 5=1: Delete display automatically, if at least one of the two inputs is set Bit 7, 6: Brightness: 00 = bright 01 = : 10 = : 11 = dark

*Bit must be set for blinking

10
Options 3
Bit 0=0: Suppress leading zeros =1: Display leading zeros Bit 1=1: +/- buttons locked Bit 2=1: +/- count unlimited (0 to 99) =0: +/- count from 0 to preset-value Bit 4, 3: cycle duration for the change Wert – Text 00 = 2 s 01 = 1.5 s 10 = 1.1 s 11 = 0.8 s Bit 5=0 don't report buttons +/- 5=1: report buttons +/- Bit 7, 6: reserved (=0)

Command Confirmation (3 bytes):

1	2	3
Address	Length	Command Confirmation
0...127	1	80 _H

Event Message (5 bytes):

1	2	3	4	5
Address	Length	Event Message	Status Byte	Value
0...127	3	00 _H	Bit 0 : Input 1 (ST3) 0: Contact OPEN 1: Contact CLOSED Bit 1 : Input 2 (ST5) 0: Contact OPEN 1: Contact CLOSED Bit 2: Status arrow UP Bit 3: Status arrow DOWN Bit 4 : Input button “-“ 0: Contact OPEN 1: Contact CLOSED Bit 5 : Input button “+“ 0: Contact OPEN 1: Contact CLOSED Bit 6=1: Display error reported Bit 7=1: Change flag for bit 0,1,4 and 5	0...99

Notes:

Bytes 6 and 7 (value) of the command define the proper display value of the pick display. This value is reported in the event message after confirmation button was pressed. The correction buttons “+” and “-“ work with this value too. Only numbers (30_H .. 39_H) or spaces (20_H) can be used for the “value”.

Bytes 4 and 5 (text) serve for the possibility to display an additional text or labeling. The fields “value” and “text” are displayed alternately then. The cycle duration can be adjusted with byte 10 (options 3).

If you don't need either field “text” or “value”, just use the space (20_H) at the relevant position of the frame. Both fields will not alternate at the display then.

7.4 Additional Commands

Show Addresses

	Address	Length	Data	
			Command	
▶	0...127, 255 = Broadcast	1	01 _H	

Command Confirmation:

	Address	Length	Data	
			Command	
◀	0...127	1	01 _H	

Delete Display

	Address	Length	Data	
			Command	
▶	0...127, 255 = Broadcast	1	02 _H	

Command Confirmation:

	Address	Length	Data	
			Command	
◀	0...127	1	02 _H	

Lamp Test

	Address	Length	Data	
			Command	Lamp Test
▶	0...127, 255 = Broadcast	2	04 _H	01 _H = start 00 _H = stop

Command Confirmation:

	Address	Length	Data	
			Command	
◀	0...127	1	04 _H	

Query Display Content

		<i>Data</i>
Address	Length	Command
0...127, 255 = Broadcast	1	05H

Command Confirmation:

		<i>Data</i>	
Address	Length	Command	Value
0...127	2	05H	0...99

Query Software Version

		<i>Data</i>
Address	Length	Command
0...127, 255 = Broadcast	1	06H

Command Confirmation:

		<i>Data</i>	
Address	Length	Command	Software Version (12 bytes)
0...127	13	06H	HLxxx-Vx.xx

Query Input States

		<i>Data</i>
Address	Length	Command
0...127, 255 = Broadcast	1	07H

Command Confirmation:

		<i>Data</i>	
Address	Length	Command	Input States
0...127	2	07H	Bit 0 = 1: Input 1 set (ST3) Bit 1 = 1: Input 2 set (ST5) Bit 2 = 1: button "+" pressed Bit 3 = 1: button "-" pressed Bit 4...7: reserved (= 0)

8 Displayable Characters

The data bytes are ASCII coded.

Lower ☞	Higher ☞	0	1	2	3	4	5	6	7
0			Segment a*	Space	0		P		
1			Segment b*		1	A			9
2			Segment c*		2			6	7
3			Segment d*		3	C	5	c	
4			Segment e*		4			d	E
5			Segment f*		5	E	U		4
6			Segment g*		6	F			
7			Point dp*		7	G			
8				C	8	H		h	
9				J	9	I	Y	,	
A						J			
B									
C						L		l	
D				-					
E								n	
F						O	_	o	

*Segment Assignment

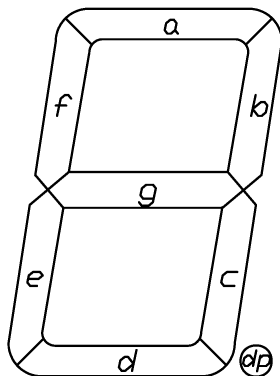

9 Declaration of Conformity

EU-Konformitätserklärung
EU Declaration of Conformity

Produktbezeichnung: mipick MP
Product name:

Typenreihe: Controller Box
Type code: mipick MP20
mipick MP80
mipick MP80T

Hersteller: microSYST Systemelectronic GmbH
Manufacturer: Albert-Einstein-Straße 7
92637 Weiden

<p>Das bezeichnete Produkt stimmt mit der folgenden Europäischen Richtlinie überein: <i>We herewith confirm that the above mentioned product meets the requirements of the following standard:</i></p>		<p>Die Übereinstimmung des bezeichneten Produk- tes mit den Vorschriften der angewandten Richt- linie(n) wird nachgewiesen durch die Einhaltung folgender Normen / Vorschriften: <i>The conformity of the product described above with the provisions of the applied Directive(s) is demon- strated by compliance with the following standards / regulations:</i></p>
Richtlinien / Directives		Europäische Norm / Standard
<p>EMV Richtlinie <i>EMC Directive</i></p>	<p>2014/30/EU</p>	EN61000-6-2:2005
		EN61000-6-3:2007 +A1:2011
<p>Niederspannungs- Richtlinie <i>Low Voltage Directive</i></p>	<p>2014/35/EU</p>	EN60950-1:2006 +A11:2009 +A1:2010 +A12:2011 +A2:2013
<p>RoHS Richtlinie <i>RoHS Directive</i></p>	<p>2011/65/EU</p>	EN50581:2012

Weiden, 03.05.2016

Manuel Raß

Geschäftsführer / General Manager

10 Versions Overview

Version	Date	Remarks, Descriptions
1.00	29.04.14	Document created
1.10	03.05.16	Declaration of conformity

Certified per **DIN EN ISO 9001**.