



Katalog

Innovation und Know-how made in Germany



Wir machen Energie messbar und sichern Ihre Zukunft











MBS AG





Niederspannungs-Stromwandler für Industrie

Rohrstab-Stromwandler

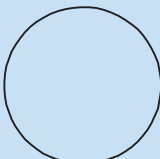
ASR 14.3	Rundleiter Wandlerbreite		Ø 14 mm 45 mm
ASR 20.3	Rundleiter Wandlerbreite		Ø 21 mm 45 mm
ASR 201.3 ohne Verschlusskappe	Rundleiter Wandlerbreite		Ø 21 mm 44 mm
ASR 21.3	Rundleiter Wandlerbreite		Ø 22,8 mm 49,5 mm
ASR 21.5	Rundleiter Wandlerbreite		Ø 21 mm 49,9 mm
ASR 22.3 ASR 22.3 2U	Rundleiter Wandlerbreite		Ø 22,5 mm 61 mm
ASR 42.45	Rundleiter Wandlerbreite Wandlertiefe		Ø 42 mm 71 mm 45 mm



ASR 14.3

Rohrstab-Stromwandler

**Stromwandler geeignet zum integrierten Einbau
in die SlimLine-Schaltleisten der Größe XR00.**



Rundleiter	14 mm
Baubreite	45 mm
Bauhöhe	65 mm
Bautiefe gesamt	30 mm

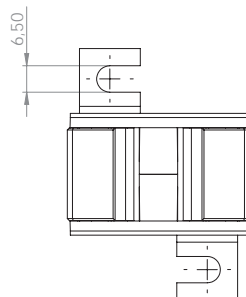
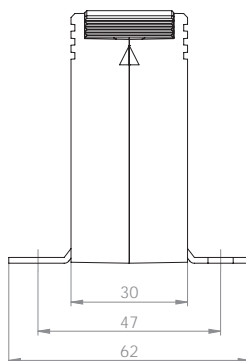
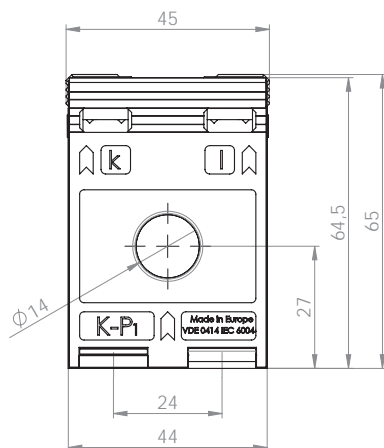

Primärstrom [A]	Bürde [VA]	Sekundärstrom [A] / Klasse	
		5 A Kl. 1 Best.-Nr.	1 A Kl. 1 Best.-Nr.
40	1	26081	26281
50	1	26085	26285
	1,5	26082	26282
60	1,5	26083	26283
75	1,5	26084	26284
100	2,5	26094	26294
125	2,5	26087	26287
150	2,5	26095	26295

		Best.-Nr.
	Schnappbefestigung Form E	55013
	Plombierplatte	-



ASR 20.3

Rohrstab-Stromwandler

Stromwandler geeignet zum integrierten Einbau in die SlimLine-Schaltleisten der Größe XR00/1.



Rundleiter 21 mm
 Baubreite 45 mm
 Bauhöhe 65 mm
 Bautiefe gesamt 30 mm

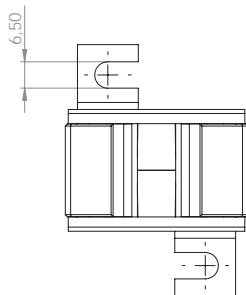
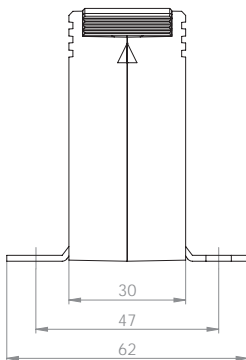
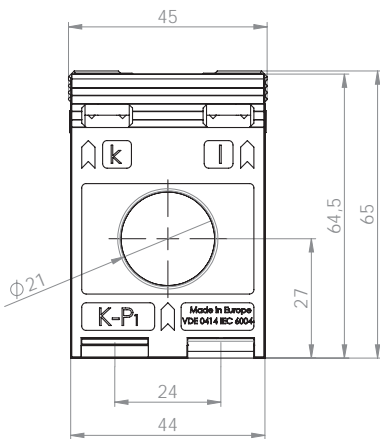

Primärstrom [A]	Bürde [VA]	Sekundärstrom [A] / Klasse			
		5 A Kl. 1 Best.-Nr.	5 A Kl. 0,5 Best.-Nr.	1 A Kl. 1 Best.-Nr.	1 A Kl. 0,5 Best.-Nr.
50	1	26027		26227	
60	1	26028		26228	
	1,25	26029		26229	
75	1,25	26030		26230	
	1,5	26031		26231	
80	1,25	26032		26232	
	1,5	26033		26233	
100	1,5	26034	26011	26234	26211
	2,5	26035		26235	
125	1,5	26036	26013	26236	26213
	2,5	26037		26237	
150	1,5	26039	26015	26239	26215
	2,5	26040	26016	26240	26216
	3,75	26041		26241	
200	1,5	26042	26017	26242	26217
	2,5	26043	26018	26243	26218
	3,75	26051			
250	2,5	26045	26020	26245	26220
	5	26046		26246	26221
300	2,5	26048	26022	26248	26222
	5	26049	26023	26249	

	Best.-Nr.
	Schnappbefestigung Form E 55013
	Plombierplatte -



ASR 201.3

Rohrstab-Stromwandler



Rundleiter 21 mm
 Baubreite 44 mm
 Bauhöhe 64,5 mm
 Bautiefe gesamt 30 mm

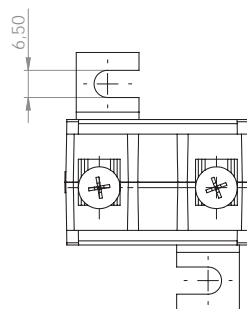
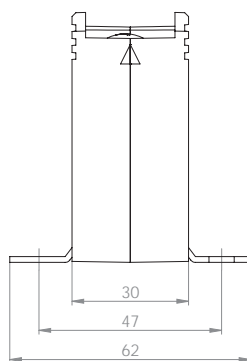
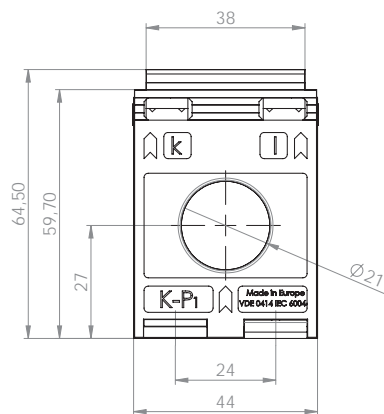

Primärstrom [A]	Bürde [VA]	Sekundärstrom [A] / Klasse			
		5 A Kl. 1 Best.-Nr.	5 A Kl. 0,5 Best.-Nr.	1 A Kl. 1 Best.-Nr.	1 A Kl. 0,5 Best.-Nr.
60	1	27028			
75	1,25	27030		27230	
	1,5	27031		27231	
80	1,25	27032		27232	
	1,5	27033		27233	
100	1,5	27034	27011	27234	27211
	2,5	27035		27235	
125	1,5	27036	27013	27236	27213
	2,5	27037	27014	27237	
150	1,5	27039	27015	27239	27215
	2,5	27040	27016	27240	
	3,75	27041		27241	
200	1,5	27042	27017	27242	27217
	2,5	27043	27018	27243	27218
	3,75	27052		27252	
	5	27044			
250	2,5	27045	27020	27245	27220
	5	27046		27246	
300	2,5	27048	27022	27248	27222
	5	27049		27249	

		Best.-Nr.
	Schnappbefestigung Form E	55013
	Plombierplatte	-



ASR 21.3

Rohrstab-Stromwandler



Rundleiter 22,8 mm
 Baubreite 49,5 mm
 Bauhöhe 65 mm
 Bautiefe gesamt 35 mm

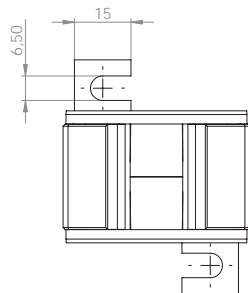
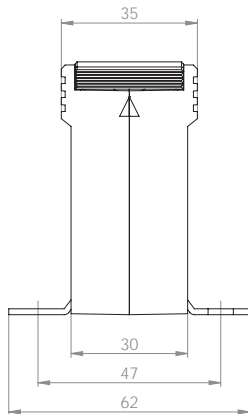
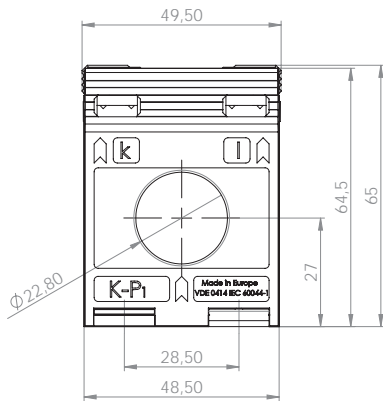

Primärstrom [A]	Bürde [VA]	Sekundärstrom [A] / Klasse	
		5 A Kl. 1 Best.-Nr.	1 A Kl. 1 Best.-Nr.
100	1	1023	1223
150	1,5	1024	1224
200	1,5	1026	1226
	2,5	1027	1227
250	1,5	1028	1228
	2,5	1029	1229
	3,75	1048	1248
	5	1030	
300	1,5	1031	1231
	2,5	1032	1232
	3,75	1049	1249
	5	1033	
400	2,5	1034	1234
	5	1035	1235
500	2,5	1037	1237
	5	1038	1238

		Best.-Nr.
	Schnappbefestigung Form F	55014
	Plombierplatte	-



ASR 21.5

Rohrstab-Stromwandler



Rundleiter 21,2 mm
 Baubreite 49,9 mm
 Bauhöhe 70 mm
 Bautiefe gesamt 55 mm

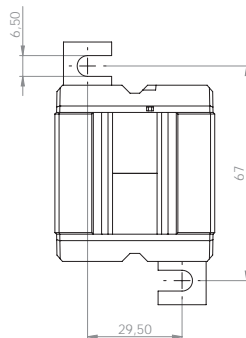
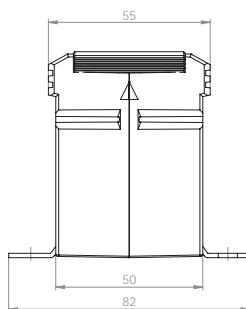
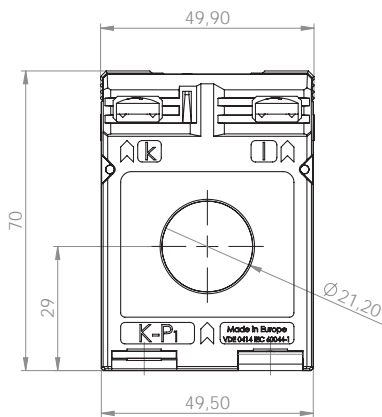

Primärstrom [A]	Bürde [VA]	Sekundärstrom [A] / Klasse			
		5 A Kl. 1 Best.-Nr.	5 A Kl. 0,5 Best.-Nr.	1 A Kl. 1 Best.-Nr.	1 A Kl. 0,5 Best.-Nr.
50	1,5	93050	93011	93250	
60	1,5	93052	93012	93252	93212
	2,5	93053		93253	
	3,75			93254	
75	1,5	93055	93013	93255	93213
	2,5	93056		93256	
	3,75	93057		93257	
80	1,5	93058	93014	93258	93214
	2,5	93059		93259	
100	1,5	93061	93015	93261	93215
	2,5	93062	93016	93262	93216
	5	93063		93263	
125	1,5	93064	93017	93264	93217
	2,5	93065	93018	93265	93218
	5	93066		93266	
150	2,5	93067	93019	93267	93219
	5	93068	93020	93268	93220
	7,5	93095		93294	
200	2,5	93070	93021	93270	93221
	5	93071	93022	93271	93222
	10	93072	93023	93272	93223
250	2,5	93074	93024	93274	93224
	5	93075	93025	93275	93225
	10	93076	93026	93276	93226
	15	93077			
300	2,5	93078	93027	93278	93227
	5	93079	93028	93279	93228
	10	93080	93029	93280	93229
400	2,5	93082	93031	93282	93231
	5	93083	93032	93283	93232
	10	93084	93033	93284	93233
500	2,5	93086	93035	93286	93235
	5	93087	93036	93287	93236
	10	93088	93037	93288	93237
600	2,5	93090	93039	93290	93239
	5	93091	93040	93291	93240
	10	93092	93041	93292	93241

		Best.-Nr.
	Schnappbefestigung	–
	Plombierplatte	–



ASR 22.3

Rohrstab-Stromwandler



Rundleiter 22,5 mm
 Baubreite 61 mm
 Bauhöhe 75,5 mm
 Bautiefe gesamt 35 mm

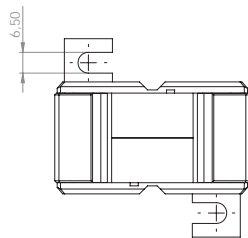
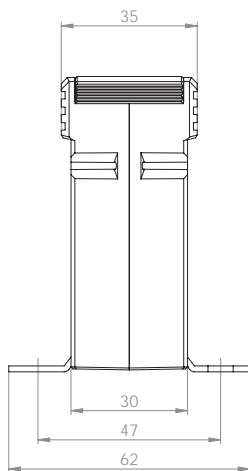
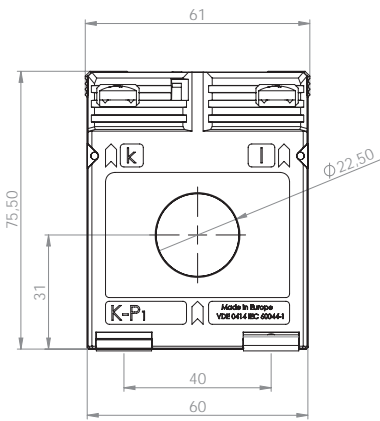

Primärstrom [A]	Bürde [VA]	Sekundärstrom [A] / Klasse				
		5 A Kl. 1 Best.-Nr.	5 A Kl. 0,5 Best.-Nr.	5 A Kl. 0,2s Best.-Nr.	1 A Kl. 1 Best.-Nr.	1 A Kl. 0,5 Best.-Nr.
50	1	3035			3235	
	1,5				3236	
60	1	3037			3237	
	1,5	3038			3238	
75	1,5	3039			3239	
	2,5	3040			3240	
80	1,5	3041			3241	
	2,5	3042			3242	
100	1,5	3043	3011		3243	3211
	2,5	3044	3134		3244	3334
	3,75	3045			3245	
150	1,5	3046	3012	V04-1604C	3246	3212
	2,5	3047	3013	V04-1604D	3247	3213
	5	3048			3248	
200	1,5		3014			3214
	2,5	3049	3015	V04-1704D	3249	3215
	5	3050	3016	V04-1704F	3250	3216
	10	3051				
250	2,5	3052	3018	V04-1804D	3252	3218
	5	3053	3019	V04-1804F	3253	3219
	10	3054			3254	
300	2,5	3056	3022	V04-1904D	3256	3222
	5	3057	3023	V04-1904F	3257	3223
	10	3058	3024		3258	3224
	15	3059			3259	
400	2,5	3060	3025	V04-2004D	3260	3225
	5	3061	3026	V04-2004F	3261	3226
	10	3062	3027		3262	3227
	15	3063			3263	
500	2,5	3064	3028	V04-2104D	3264	3228
	5	3065	3029	V04-2104F	3265	3229
	10	3066	3030	V04-2104H	3266	3230
600	2,5	3068	3031	V04-2204D	3268	3231
	5	3069	3032	V04-2204F	3269	3232
	10	3070	3033	V04-2204H	3270	3233

		Best.-Nr.
	Schnappbefestigung Form A	53011
	Plombierplatte Form A	59040



ASR 22.3 2U

Rohrstab-Stromwandler, sekundär umschaltbar



Rundleiter 22,5 mm
 Baubreite 61 mm
 Bauhöhe 75,5 mm
 Bautiefe gesamt 35 mm

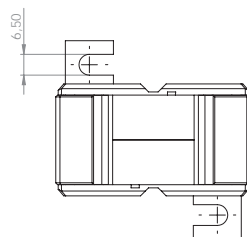
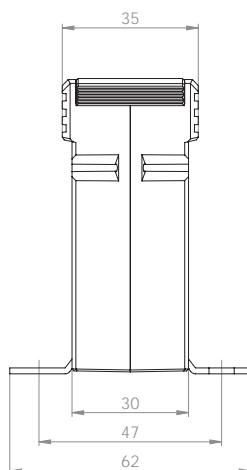
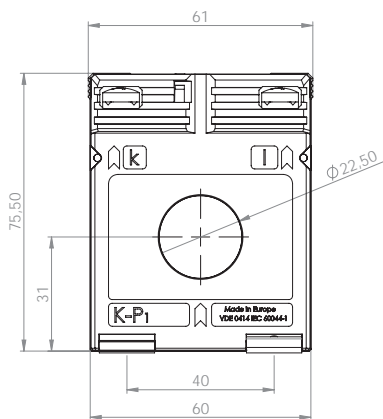

Primärstrom [A]	Bürde [VA]	Sekundärstrom [A] / Klasse	
		5 A Kl. 1 Best.-Nr.	1 A Kl. 1 Best.-Nr.
200-100	5-2,5	3111	3311
300-150	5-2,5	3112	3312
	10-5	3113	3313
400-200	5-2,5	3114	3314
	10-5	3115	3315
500-250	5-2,5	3116	3316
	10-5	3117	3317
600-300	5-2,5	3118	3318
	10-5	3119	3319

		Best.-Nr.
	Schnappbefestigung Form A	53011
	Plombierplatte Form A	59040



ASR 42.45

Rohrstab-Stromwandler



Rundleiter 42 mm
 Baubreite 71 mm
 Bauhöhe 71 mm
 Bautiefe gesamt 45 mm

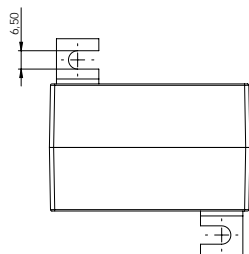
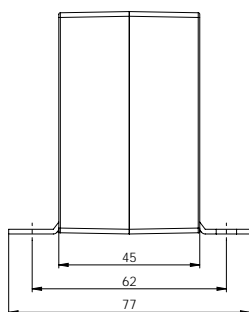
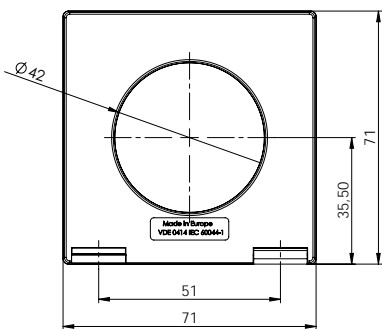

Primärstrom [A]	Bürde [VA]	Sekundärstrom [A] / Klasse	
		5 A Kl. 1 Best.-Nr.	1 A Kl. 1 Best.-Nr.
150	1,5	26500	26600
	2,5	26501	26601
200	1,5	26502	26602
	2,5	26503	26603
	5	26504	26604
250	1,5	26505	26605
	2,5	26506	26606
	5	26507	26607
	7,5	26508	
300	2,5	26509	26609
	5	26510	26610
	7,5	26536	26644
400	2,5	26512	26612
	5	26513	26613
	10	26514	26614
500	2,5	26515	26615
	5	26516	26616
	10	26517	26617
600	2,5	26519	26619
	5	26520	26620
	10	26521	26621
	15	26522	26622
750	2,5	26523	26623
	5	26524	26624
	10	26525	26625
	15	26526	26626
800	5	26527	26627
	10	26528	26628

		Best.-Nr.
	Schnappbefestigung	-
	Plombierplatte	-

- Anschlusskabel 2,5 mm², 400 mm lang (Standard)
- Die Kabelenden sind mit Aderendhülsen versehen.

ASR

ASG

AS / ASK

WSK

KBR / KBU

KSU / SUJK

NH

SASR / SASK

ASRD

ASKD / WSKD

CTB



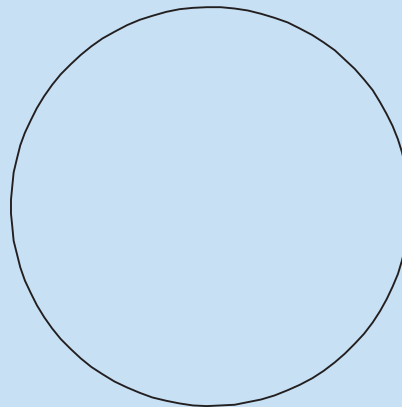

Stromwandler, PU-vergossen

ASG 210.3Rundleiter
WandlerbreiteØ 21 mm
44 mm**ASG 106**Rundleiter
WandlerbreiteØ 106 mm
190 mm**ASG 123**Schiene 1
Schiene 2
Rundleiter
Wandlerbreite120 x 30 mm
2 x 120 x 10 mm
Ø 30 mm
190 mm



ASG 210.3

Rohrstab-Stromwandler, ausgegossen

Rundleiter 20,8 mm
 Baubreite 44 mm
 Bauhöhe 55,5 mm
 Bautiefe gesamt 30 mm

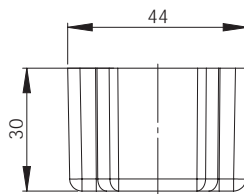
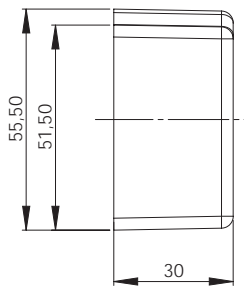
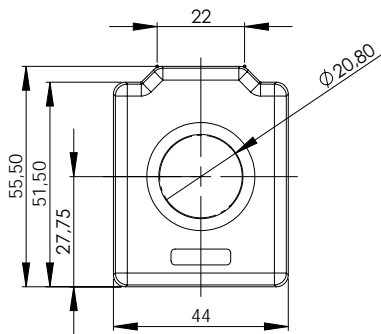

Primärstrom [A]	Bürde [VA]	Sekundärstrom [A] / Klasse	
		5 A Kl. 1 Best.-Nr.	1 A Kl. 1 Best.-Nr.
60	1	27501	27601
	1,25		27602
75	1,25	27503	27603
	1,5	27504	27604
80	1,25	27505	27605
	1,5	27506	27606
100	1,5	27507	27607
	2,5	27508	27608
125	1,5	27509	27609
	2,5	27510	27610
150	1,5	27512	27612
	2,5	27513	27613
	3,75	27514	27614
200	1,5	27515	27615
	2,5	27516	27616
	3,75	27527	27627
	5		27617
250	2,5	27518	27618
	3,75	27528	27628
	5	27519	27619
300	2,5	27521	27621
	5	27522	27622
	7,5		27623

		Best.-Nr.
	Schnappbefestigung	–
	Plombierplatte	–

- Anschlusskabel 2,5 mm², 400 mm lang (Standard)
- Die Kabelenden sind mit Aderendhülsen versehen.



ASG 106

Rohrstab-Stromwandler, PU-vergossen, Mess- und Schutzwandler in einem Gehäuse, bis zu vier Messsysteme, für Niederspannungsschaltanlagen sowie abgeregelte SF6-isolierte Mittelspannungsschaltanlagen

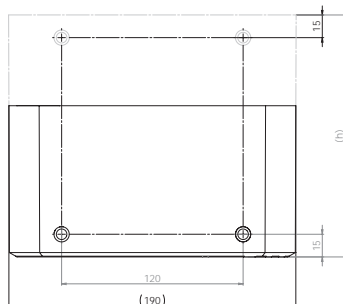
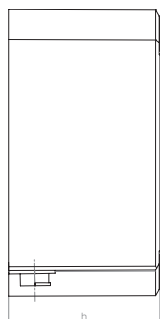
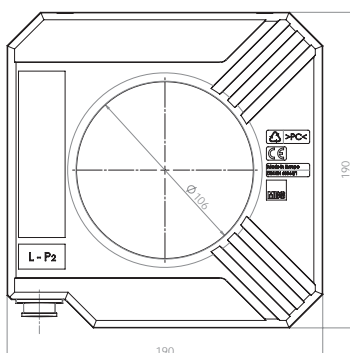

Merkmale / Nutzen

- Einleiter-Stromwandler mit kreisrunder Primärleiteröffnung, Durchmesser 106 mm
- 1...4 verschiedene Messsysteme in einem Gehäuse realisierbar
- Primäre Bemessungsspannung (Leiter-Leiter-Spannung) $U_m \leq 0,72$ kV
- Isolationsprüfspannung: 3 kV, U_{eff} 50 Hz, 1 Min.
- Sekundäre Nennströme 1 A, 5 A oder 2 A
- Sekundäre Bemessungsscheinleistungen 2,5 VA bis 30 VA
- Messwandler lieferbar in den Genauigkeitsklassen 0,2; 0,2s; 0,5; 0,5s; 1; 3
- Schutzwandler lieferbar in den Genauigkeitsklassen 5P, 10P und PX
- Messsystemkombinationen aus Mess- und Schutzstromwandlern realisierbar
- Alle Messsysteme mit PU-Harz entsprechend UL94-V0 vergossen
- Wandler einsetzbar unter erhöhten mechanischen und klimatischen Anforderungen
- Kompakte Bauformen durch Verfügbarkeit von vier unterschiedlichen Gehäusebautiefen (50 / 100 / 170 / 214 mm)
- Minimaler Aufwand bei der Verdrahtung des Sekundärkreises durch fest installierte flexible Anschlussleitungen (Standard: 3,6 m, 4 mm²)
- Auf Kundenwunsch auch Wandler mit zwei primären Messbereichen (sekundär umschaltbare Ausführungen) lieferbar
- PTB-Zulassung für Verrechnungszwecke

Anwendung

Stromwandler des Typs ASG 106 wurden für den Einsatz in SF6-isolierten Mittelspannungsschaltanlagen sowie Niederspannungsschaltanlagen konzipiert. Fest installierte, flexible Sekundäranschlussleitungen, eine große Primärleiteröffnung sowie die mögliche Kombination mehrerer Messsysteme in einem Gehäuse ermöglichen eine zeit- und platzsparende Montage dieser Stromwandler. Dank ihrer vollvergossenen Messsysteme gestatten sie den Einsatz auch unter erhöhten mechanischen und klimatischen Anforderungen. Der modulare Aufbau des Gehäusesystems gestattet die Realisierung unterschiedlicher Messsystemkonfigurationen in einem Gehäuse.



Technische Kennwerte

ASG Attribute

Typ	Einleiter-Niederspannungs-Stromwandler, einphasig, Messsysteme PU-Harz vergossen, UL94-V0
Gehäusematerial	ABS / UL94-V0
Max. Spannung für elektrische Betriebsmittel U_m	$\leq 0,72$ kV
Isolationsprüfspannung U_{iso}	3 kV, U_{eff} , 50 Hz, 1 min
Bemessungsfrequenz	50 Hz oder 60 Hz andere Werte auf Anfrage
Sekundäranschlüsse	Flexible Cu-Litze-Leitungen H07V-K1X4, 4 mm ² , 3,6 m Standard andere Längen und Querschnitte auf Anfrage
Primäre Bemessungsstromstärken	40 ... 1250 A
Sekundäre Bemessungsstromstärken	1 A, 5 A oder 2 A
Sekundäre Bemessungsbürden	2,5 VA ... 30 VA
Genauigkeitsklassen Messwandler	0,2; 0,2s; 0,5; 0,5s; 1; 3

Genauigkeitsklassen Schutzwandler	5P; 10P; PX
Überstrombegrenzungsfaktor FS (Messwandler)	FS5 bzw. FS10 (siehe Leistungsschild)
Thermische Bemessungsdauerstromstärke I_{CTH}	$1,2 \times I_N$, Standard andere Werte auf Anfrage
Thermische Bemessungskurzzeitstromstärke I_{TTH}	25 kA / 3 s, Standard andere Werte auf Anfrage
Bemessungsstoßstromstärke I_{DYN}	$2,5 \times I_{CTH}$
Einsatztemperaturbereich	-5 ... +60 °C
Max. Temperatur des Primärleiters	70 °C
Thermische Kurzzeitüberlastbarkeit	$1,5 \times I_N$ / 60 min $2,0 \times I_N$ / 30 min
Isolierstoffklasse	E
Angewendete Normen	IEC 61869/1+2 (vormals IEC 60044-1)
Abmessungen (B x H x T)	190 x 190 x (50 / 100 / 170 / 214*) mm * Bautiefe abhängig von Art und Anzahl der Messsysteme
Primärleiter	Ø 106 mm
Schutzklasse	IP 50

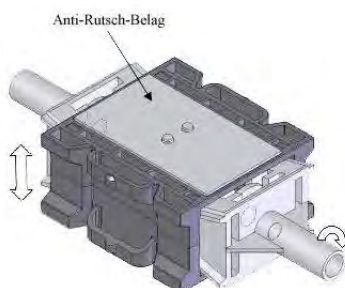
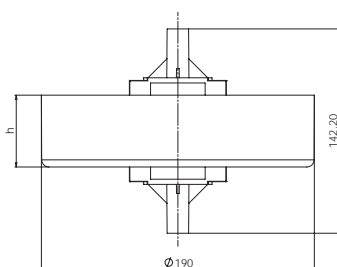
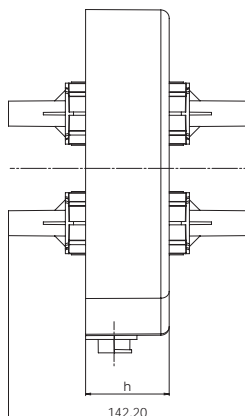
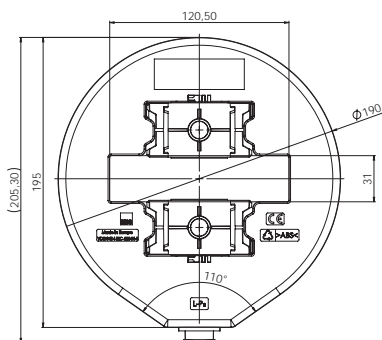

ASG 123

Aufsteck-Stromwandler, PU-vergossen, Mess- und Schutzwandler in einem Gehäuse, bis zu drei Messsysteme, für Niederspannungsschaltanlagen sowie abgeregelte SF6-isolierte Mittelspannungsschaltanlagen

Merkmale / Nutzen

- Einleiter-Stromwandler für Primärleiterabmessungen bis 2 x 120 x 10 mm
- Direkte, einfache Montage auf dem Primärleiter durch im Lieferumfang enthaltene Spannmodule
- 1...3 verschiedene Messsysteme in einem Gehäuse realisierbar
- Primäre Bemessungsspannung (Leiter-Leiter-Spannung) $U_m \leq 1,2 \text{ kV}$
- Isolationsprüfspannung: 6 kV, U_{eff} 50 Hz, 1 Min.
- Sekundäre Nennströme 1 A, 5 A oder 2 A
- Sekundäre Bemessungsscheinleistungen 2,5 VA bis 30 VA
- Messwandler lieferbar in den Genauigkeitsklassen 0,2; 0,2s; 0,5; 0,5s; 1; 3
- Schutzwandler lieferbar in den Genauigkeitsklassen 5P, 10P und PX
- Messsystemkombinationen aus Mess- und Schutzstromwandlern realisierbar
- Alle Messsysteme mit PU-Harz entsprechend UL94-V0 vergossen
- Wandler einsetzbar unter erhöhten mechanischen und klimatischen Anforderungen
- Kompakte Bauformen durch Verfügbarkeit von drei unterschiedlichen Gehäusebautiefen (50 / 100 / 125 mm)
- Minimaler Aufwand bei der Verdrahtung des Sekundärkreises durch fest installierte flexible Anschlussleitungen (Standard: 1,5 m, 4 mm²)
- Auf Kundenwunsch auch Wandler mit zwei primären Messbereichen (sekundär umschaltbare Ausführungen) lieferbar

Anwendung

Stromwandler des Typs ASG 123 wurden für den Einsatz in Niederspannungsschaltanlagen konzipiert. Dank ihrer vollvergossenen Messsysteme gestatten sie den Einsatz unter erhöhten mechanischen und klimatischen Anforderungen. Fest installierte, flexible Sekundäranschlussleitungen, eine große Primärleiteröffnung sowie die mögliche Kombination mehrerer Messsysteme in einem Gehäuse ermöglichen eine zeit- und platzsparende Montage dieser Stromwandler. Der modulare Aufbau des Gehäusesystems gestattet die Realisierung unterschiedlicher Messsystemkonfigurationen in einem Gehäuse.



Technische Kennwerte

ASG Attribute

Typ	Einleiter-Niederspannungs-Stromwandler, einphasig, Messsysteme PU-Harz vergossen, UL94-V0
Gehäusematerial	ABS / UL94-V0
Max. Spannung für elektrische Betriebsmittel U_m	$\leq 1,2$ kV
Isolationsprüfspannung U_{iso}	6 kV, U_{eff} , 50 Hz, 1 min
Bemessungsfrequenz	50 Hz oder 60 Hz andere Werte auf Anfrage
Sekundäranschlüsse	Flexible Cu-Litze-Leitungen H07V-K1X4, 4 mm ² , 1,5 m Standard andere Längen und Querschnitte auf Anfrage
Primäre Bemessungsstromstärken	400 ... 4000 A
Sekundäre Bemessungsstromstärken	1 A, 5 A oder 2 A
Sekundäre Bemessungsbürden	2,5 VA ... 30 VA
Genauigkeitsklassen Messwandler	0,2; 0,2s; 0,5; 0,5s; 1; 3
Genauigkeitsklassen Schutzwandler	5P; 10P; PX

Überstrombegrenzungsfaktor FS (Messwandler)	FS5 bzw. FS10 (siehe Leistungsschild)
Thermische Bemessungsdauerstromstärke I_{CTH}	$1,2 \times I_N$, Standard andere Werte auf Anfrage
Thermische Bemessungskurzzeitstromstärke I_{TTH}	25 kA / 3 s, Standard andere Werte auf Anfrage
Bemessungsstoßstromstärke I_{DYN}	$2,5 \times I_{CTH}$
Einsatztemperaturbereich	-5 ... +60 °C
Max. Temperatur des Primärleiters	70 °C
Thermische Kurzzeitüberlastbarkeit	$1,5 \times I_N / 60$ min $2,0 \times I_N / 30$ min
Isolierstoffklasse	F
Angewendete Normen	IEC 61869/1+2 (vormals IEC 60044-1)
Abmessungen (B x H x T)	190 x 195 x (50 / 100 / 125*) mm * Bautiefe abhängig von Art und Anzahl der Messsysteme
Primärleiter	Max. 2 x 120 x 10 mm Primärleiteröffnung 120,5 x 31 mm
Schutzklasse	IP 50





Niederspannungs-Stromwandler für Industrie

Aufsteck-Stromwandler

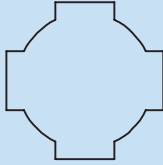
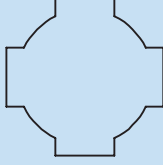
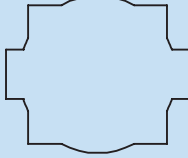
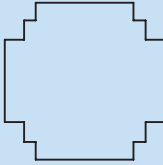
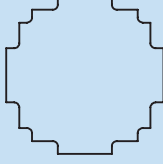
AS 176.3	Primärleiter Rundleiter Wandlerbreite		17 x 6 mm Ø 15 mm 49,5 mm
ASK 176.3	Primärleiter Rundleiter Wandlerbreite		17 x 6 mm Ø 15 mm 49,5 mm
ASK 205.3	Primärleiter Rundleiter Wandlerbreite		20 x 5 mm Ø 17,5 mm 49,5 mm
ASK 21.3	Primärleiter Rundleiter Wandlerbreite		20 x 10 mm Ø 19,2 mm 61 mm
ASK 231.5	Primärleiter Rundleiter Wandlerbreite		30 x 10 mm Ø 28 mm 50 mm



AS 176.3

Aufsteck-Stromwandler

**Stromwandler geeignet zum integrierten Einbau
in die SlimLine-Schaltleisten der Größe XR1.**



Schiene 1	17 x 6 mm
Rundleiter	15,2 mm
Baubreite	45 mm
Bauhöhe	65 mm
Bautiefe gesamt	30 mm

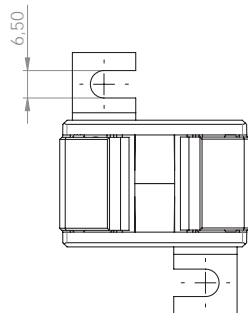
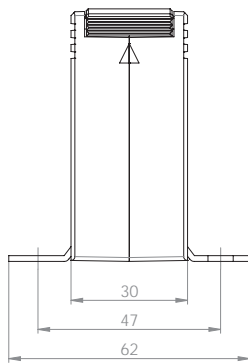
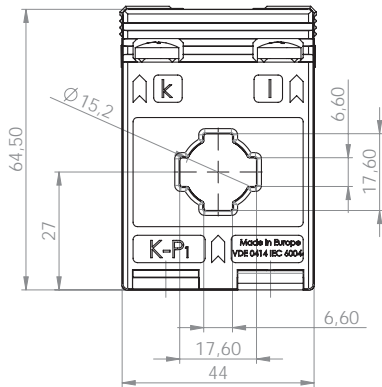

Primärstrom [A]	Bürde [VA]	Sekundärstrom [A] / Klasse			
		5 A Kl. 1 Best.-Nr.	5 A Kl. 0,5 Best.-Nr.	1 A Kl. 1 Best.-Nr.	1 A Kl. 0,5 Best.-Nr.
75	1,5	1030006009		1030206009	
80	1,5	1030006010		1030206010	
100	1		1030005007		1030205007
	2	1030006001		1030206001	
125	1,5		1030005008		1030205008
	2,5	1030006002		1030206002	
150	1,5	1030006007	1030005001	1030206007	1030205001
	2,5	1030006003	1030005006	1030206003	1030205006
160	2,5	1030006004	1030005004	1030206004	1030205004
200	2,5	1030006005	1030005002	1030206005	1030205002
250	2,5	1030006008	1030005003	1030206008	1030205003
	3,75	1030006006	1030005005	1030206006	1030205005

		Best.-Nr.
	Schnappbefestigung Form E	55013
	Plombierplatte	-



ASK 176.3

Aufsteck-Stromwandler



- Schiene 1 17 x 6 mm
- Rundleiter 15,2 mm
- Baubreite 45 mm
- Bauhöhe 65 mm
- Bautiefe gesamt 46 mm

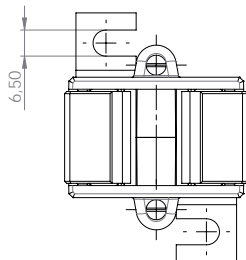
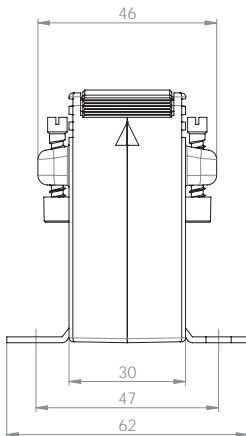
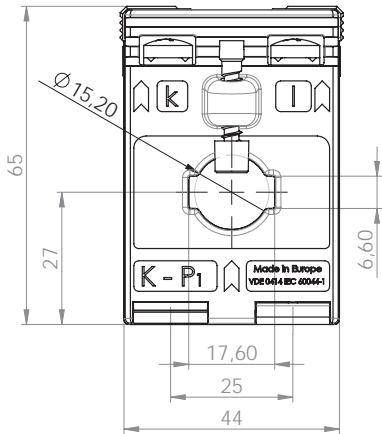

Primärstrom [A]	Bürde [VA]	Sekundärstrom [A] / Klasse			
		5 A Kl. 1 Best.-Nr.	5 A Kl. 0,5 Best.-Nr.	1 A Kl. 1 Best.-Nr.	1 A Kl. 0,5 Best.-Nr.
75	1,5	1020006009		1020206009	
80	1,5	1020006010		1020206010	
100	1		1020005007		1020205007
	2	1020006001		1020206001	
125	1,5		1020005008		1020205008
	2,5	1020006002		1020206002	
150	1,5	1020006007	1020005001	1020206007	1020205001
	2,5	1020006003	1020005006	1020206003	1020205006
160	2,5	1020006004	1020005004	1020206004	1020205004
200	2,5	1020006005	1020005002	1020206005	1020205002
250	2,5	1020006008	1020005003	1020206008	1020205003
	3,75	1020006006		1020206006	

	Best.-Nr.
	Schnappbefestigung Form E 55013
	Plombierplatte -

ASR

ASG

AS/ASK

WSK

KBR / KBU

KSU / SUJK

NH

SASR / SASK

ASRD

ASKD / WSKD

CTB



ASK 205.3

Aufsteck-Stromwandler



Schiene 1	20 x 5 mm
Rundleiter	17,5 mm
Baubreite	49,5 mm
Bauhöhe	65 mm
Bautiefe gesamt	50 mm

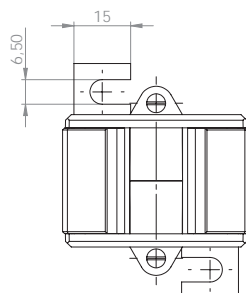
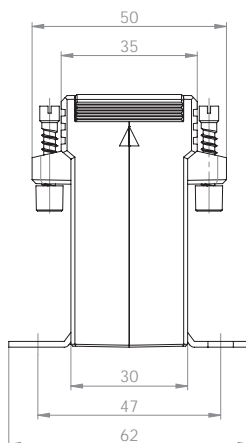
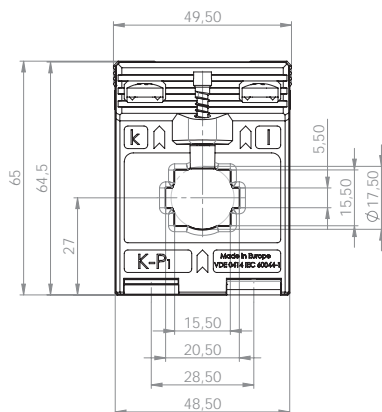

Primärstrom [A]	Bürde [VA]	Sekundärstrom [A] / Klasse	
		5 A Kl. 1 Best.-Nr.	1 A Kl. 1 Best.-Nr.
60	1	2019	2219
75	1	2020	2220
80	1,25	2021	2221
	1,5	2022	2222
100	1,25	2022	2222
	1,5	2023	2223
150	1,5	2024	2224
	2,5	2025	2225
200	1,5	2026	2226
	2,5	2027	2227
250	2,5	2028	2228
	5	2029	2229
300	2,5	2030	2230
	5	2031	2231
400	2,5	2032	2232
	5	2033	2233

		Best.-Nr.
	Schnappbefestigung Form F	55014
	Plombierplatte	—



ASK 21.3

Aufsteck-Stromwandler



- Schiene 1 20 x 10 mm
- Rundleiter 19,2 mm
- Baubreite 61 mm
- Bauhöhe 75,5 mm
- Bautiefe gesamt 48 mm

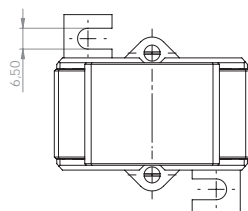
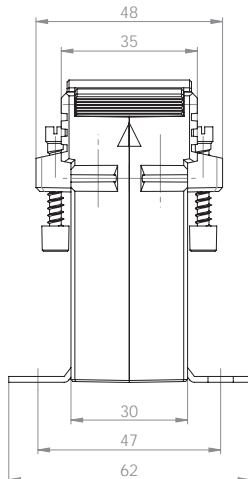
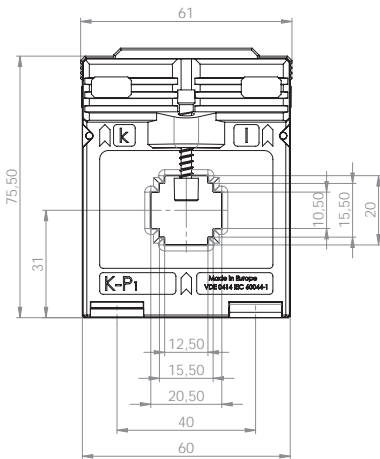

Primärstrom [A]	Bürde [VA]	Sekundärstrom [A] / Klasse				
		5 A Kl. 1 Best.-Nr.	5 A Kl. 0,5 Best.-Nr.	5 A Kl. 0,2s Best.-Nr.	1 A Kl. 1 Best.-Nr.	1 A Kl. 0,5 Best.-Nr.
50	1	6035			6235	
60	1	6037			6237	
	1,5	6038			6238	
75	1,5	6039			6239	
	2,5	6040			6240	
80	1,5	6041			6241	
	2,5	6042			6242	
100	1,5	6043	6011		6243	6211
	2,5	6044	6111		6244	6311
	3,75	6077			6277	
150	1,5	6046	6012	V10-1604C	6246	6212
	2,5	6047	6013	V10-1604D	6247	6213
	5	6048			6248	
200	2,5	6049	6015	V10-1704D	6249	6215
	5	6050	6016	V10-1704F	6250	6216
	7,5	6083			6283	
250	10	6051			6251	
	2,5	6052	6018	V10-1804D	6252	6218
	5	6053	6019	V10-1804F	6253	6219
300	10	6054	6020		6254	6220
	2,5	6056	6022	V10-1904D	6256	6222
	5	6057	6023	V10-1904F	6257	6223
400	10	6058	6024		6258	6224
	2,5	6060	6025	V10-2004D	6260	6225
	5	6061	6026	V10-2004F	6261	6226
500	10	6062	6027		6262	6227
	15	6063			6263	
	2,5	6064	6028	V10-2104D	6264	6228
500	5	6065	6029	V10-2104F	6265	6229
	10	6066	6030		6266	6230

		Best.-Nr.
	Schnappbefestigung Form A	53011
	Plombierplatte Form A	59040

ASR

ASG

ASK

WSK

KBR / KBU

KSU / SUJK

NH

SASR / SASK

ASRD

ASKD / WSKD

CTB



ASK 231.5

Aufsteck-Stromwandler



Schiene 1	30 x 10 mm
Rundleiter	28 mm
Baubreite	50 mm
Bauhöhe	70 mm
Bautiefe gesamt	68 mm

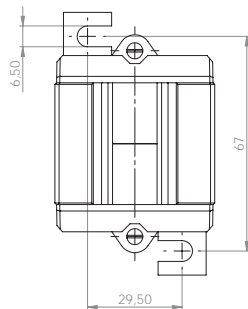
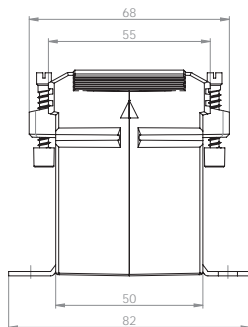
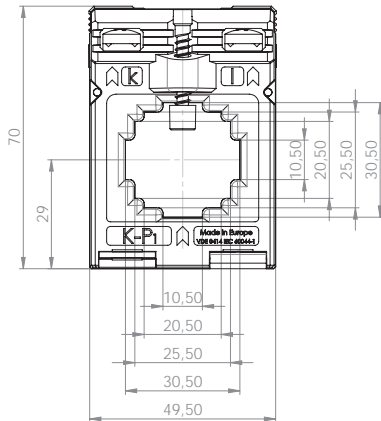

Primärstrom [A]	Bürde [VA]	Sekundärstrom [A] / Klasse			
		5 A Kl. 1 Best.-Nr.	5 A Kl. 0,5 Best.-Nr.	1 A Kl. 1 Best.-Nr.	1 A Kl. 0,5 Best.-Nr.
60	1	92052		92252	
75	1,25	92054		92254	
80	1,25	92056		92256	
100	1,5	92059		92259	
125	1,5	92062		92262	92220
	2,5	92063		92263	
150	1,5	92065		92265	92223
	2,5	92066		92266	
200	2,5	92068	92026	92268	92226
	2,5	92071	92028	92271	92228
250	5			92272	
	2,5	92074	92030	92274	92230
300	5	92075		92275	
	2,5	92077	92032	92277	92232
400	5	92078	92033	92278	92233
	2,5	92081	92035	92281	92235
500	5	92082	92036	92282	92236

		Best.-Nr.
	Schnappbefestigung	–
	Plombierplatte	–



Niederspannungs-Stromwandler für Industrie

Aufsteck-Stromwandler

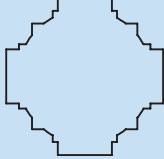
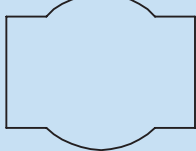
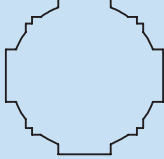
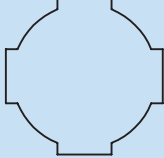
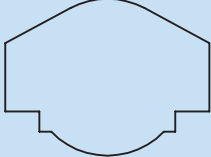
ASK 31.3 ASK 31.3 2U	Primärleiter		30 x 10 mm
	Rundleiter Wandlerbreite		2 x 20 x 10 mm Ø 26 mm 61 mm
ASK 318.3	Primärleiter		31 x 18 mm
	Rundleiter		Ø 26 mm
	Wandlerbreite		61 mm
ASK 31.4 ASK 31.4 2U ASK 31.4 3U	Primärleiter		30 x 10 mm
	Rundleiter		2 x 20 x 10 mm Ø 28 mm
	Wandlerbreite		61 mm
ASK 31.5 ASK 31.5 2U	Primärleiter		30 x 10 mm
	Rundleiter Wandlerbreite		2 x 20 x 10 mm Ø 28 mm 61 mm
ASK 31.6	Primärleiter		30 x 10 mm
	Rundleiter		20 x 13 mm Ø 23 mm
	Wandlerbreite		95 mm



ASK 31.3

Aufsteck-Stromwandler



Schiene 1	30 x 10 mm
Schiene 2	2 x 20 x 10 mm
Rundleiter	26 mm
Baubreite	61 mm
Bauhöhe	75,5 mm
Bautiefe gesamt	48 mm

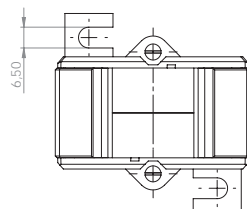
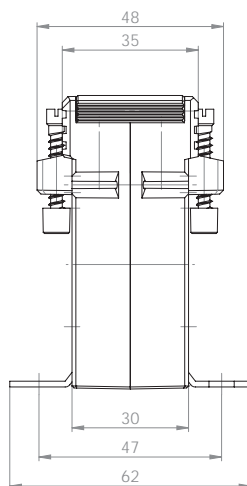
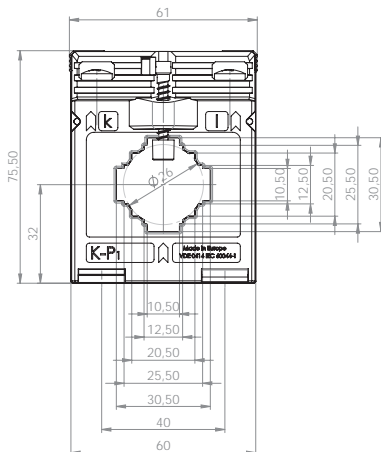

Primärstrom [A]	Bürde [VA]	Sekundärstrom [A] / Klasse				
		5 A Kl. 1 Best.-Nr.	5 A Kl. 0,5 Best.-Nr.	5 A Kl. 0,2s Best.-Nr.	1 A Kl. 1 Best.-Nr.	1 A Kl. 0,5 Best.-Nr.
50	1	7038			7238	
60	1	7039			7239	
75	1	7040			7240	
	1,5	7041			7241	
80	1,5	7042			7242	
	2,5	7043			7243	
100	1,5	7044	7011		7244	7211
	2,5	7045	7012		7245	7212
150	1,5	7046	7013	V11-1604C	7246	7213
	2,5	7047	7014		7247	7214
200	1,5	7048	7015	V11-1704C	7248	7215
	2,5	7049	7016	V11-1704D	7249	7216
	5	7050	7017		7250	
250	1,5	7051	7018	V11-1804C	7251	7218
	2,5	7052	7019	V11-1804D	7252	7219
	5	7053	7020	V11-1804F	7253	7220
300	1,5	7055	7021	V11-1904C	7255	7221
	2,5	7056	7022	V11-1904D	7256	7222
	5	7057	7023	V11-1904F	7257	7223
	10	7058			7258	7224
400	1,5	7059		V11-2004C	7259	
	2,5	7060	7025	V11-2004D	7260	7225
	5	7061	7026	V11-2004F	7261	7226
500	10	7062			7262	
	2,5	7063	7028	V11-2104D	7263	7228
	5	7064	7029	V11-2104F	7264	7229
600	10	7065	7030		7265	7230
	2,5	7066	7031	V11-2204D	7266	7231
	5	7067	7032	V11-2204F	7267	7232
750	10	7068	7033		7268	7233
	2,5	7070	7035	V11-2304D	7270	7235
	5	7071	7036	V11-2304F	7271	7236
	10	7072	7037		7272	7237

		Best.-Nr.
	Schnappbefestigung Form A	53011
	Plombierplatte Form A	59040



ASK 31.3 2U

Aufsteck-Stromwandler, sekundär umschaltbar



- Schiene 1 30 x 10 mm
- Schiene 2 2 x 20 x 10 mm
- Rundleiter 26 mm
- Baubreite 61 mm
- Bauhöhe 75,5 mm
- Bautiefe gesamt 48 mm

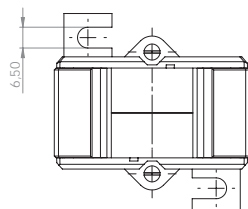
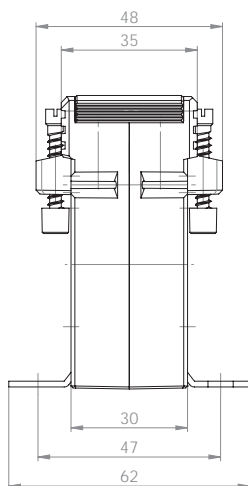
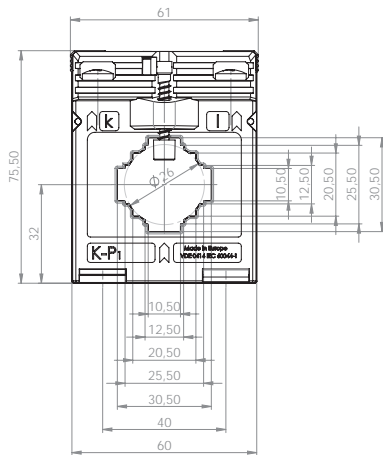

Primärstrom [A]	Bürde [VA]	Sekundärstrom [A] / Klasse	
		5 A Kl. 1 Best.-Nr.	1 A Kl. 1 Best.-Nr.
200-100	5-2,5	7111	7311
300-150	5-2,5	7112	7312
400-200	5-2,5	7113	7313
	10-5	7114	7314
500-250	5-2,5	7115	7315
	10-5	7116	7316
600-300	10-5	7117	7317

		Best.-Nr.
	Schnappbefestigung Form A	53011
	Plombierplatte Form A	59040

ASR

ASG

ASK

WSK

KBR / KBU

KSU / SJSK

NH

SASR / SASK

ASRD

ASKD / WSKD

CTB



MBS AG



ASK 318.3

Aufsteck-Stromwandler



Schiene 1	31 x 18 mm
Rundleiter	26 mm
Baubreite	61 mm
Bauhöhe	75,5 mm
Bautiefe gesamt	48 mm

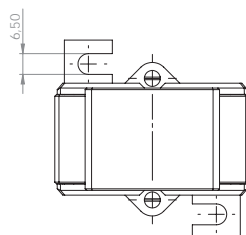
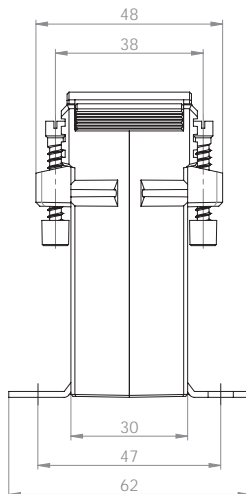
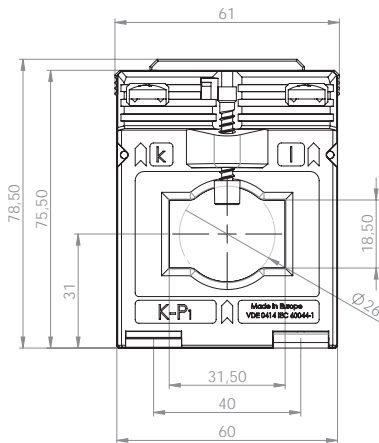

Primärstrom [A]	Bürde [VA]	Sekundärstrom [A] / Klasse			
		5 A Kl. 1 Best.-Nr.	5 A Kl. 0,5 Best.-Nr.	1 A Kl. 1 Best.-Nr.	1 A Kl. 0,5 Best.-Nr.
60	1	29042			
80	1,5	29045		29245	
100	1,5	29047	29011	29247	29211
	2,5	29048		29248	
150	1,5	29049	29013	29249	29213
	2,5	29050		29250	29214
200	2,5	29052	29016	29252	29216
	3,75	29054		29254	
250	5			29253	
	2,5	29055	29019	29255	29219
300	5	29056	29020	29256	
	2,5	29059	29023	29259	29223
400	5	29060	29024	29260	29224
	2,5	29063	29027	29263	29227
500	5	29064	29028	29264	29228
	7,5	29077		29277	
	10	29065		29265	
600	2,5	29066	29030	29266	29230
	5	29067	29031	29267	29231
	10	29068		29268	
600	2,5	29069	29033	29269	29233
	5	29070	29034	29270	29234
	10	29071	29035	29271	29235

		Best.-Nr.
	Schnappbefestigung Form A	53011
	Plombierplatte Form A	59040



ASK 31.4

Aufsteck-Stromwandler



- Schiene 1 30 x 10 mm
- Schiene 2 2 x 20 x 10 mm
- Rundleiter 28 mm
- Baubreite 61 mm
- Bauhöhe 75,5 mm
- Bautiefe gesamt 58 mm

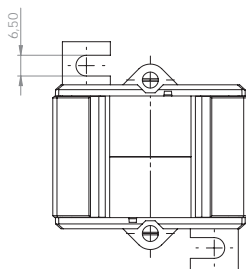
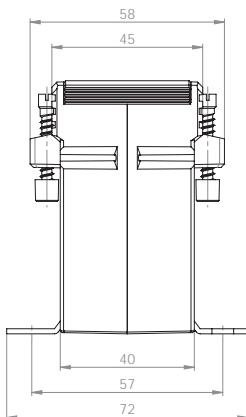
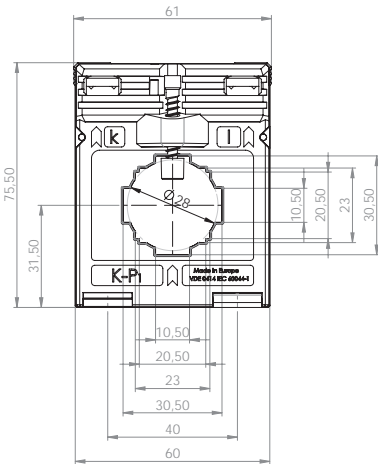

Primärstrom [A]	Bürde [VA]	Sekundärstrom [A] / Klasse				
		5 A Kl. 1 Best.-Nr.	5 A Kl. 0,5 Best.-Nr.	5 A Kl. 0,2s Best.-Nr.	1 A Kl. 1 Best.-Nr.	1 A Kl. 0,5 Best.-Nr.
50	1,25	8157			8357	
	1,5	8038				
60	1,25	8158			8358	
	1,5	8039			8239	
75	1,5	8041			8241	
	2,5	8042			8242	
80	1,5	8043			8243	
	2,5	8044			8244	
100	1,5	8045	8011		8245	8211
	2,5	8046	8010		8246	8210
	3,75	8152			8276	
150	1,5	8048	8012	V14-1604C	8248	8212
	2,5	8049	8013	V14-1604D	8249	8213
	5	8050	8410		8250	
	7,5				8251	
200	2,5	8052	8014	V14-1704D	8252	8214
	5	8053	8015	V14-1704F	8253	8215
	7,5	8161			8281	
	10				8254	
250	2,5	8055	8016	V14-1804D	8255	8216
	5	8056	8017	V14-1804F	8256	8217
	10	8057			8257	
300	2,5	8059	8018	V14-1904D	8259	8218
	5	8060	8019	V14-1904F	8260	8219
	10	8061	8020		8261	8220
	15				8262	
400	2,5	8063	8021	V14-2004D	8263	8221
	5	8064	8022	V14-2004F	8264	8222
	10	8065	8023		8265	8223
	15				8266	8224
500	2,5	8067	8025	V14-2104D	8267	8225
	5	8068	8026	V14-2104F	8268	8226
	10	8069	8027		8269	8227
600	2,5	8071	8029	V14-2204D	8271	8229
	5	8072	8030	V14-2204F	8272	8230
	10	8073	8031	V14-2204H	8273	8231
	15	8074	8032		8274	8232
750	2,5	8153	8033	V14-2304D	8353	8233
	5	8154	8034	V14-2304F	8354	8234
	10	8155	8035	V14-2304H	8355	8235
	15	8156	8036		8356	8236

		Best.-Nr.
	Schnappbefestigung Form B	54011
	Plombierplatte Form B	59041

ASR

ASG

ASK

WSK

KBU

KBR / KBU

SJSK

SJSK

NH

SASK

SASK

ASRD

ASRD

ASRD

ASRD

ASRD

ASRD

ASRD

ASRD



ASK 31.4 2U

Aufsteck-Stromwandler, sekundär umschaltbar

Schiene 1	30 x 10 mm
Schiene 2	2 x 20 x 10 mm
Rundleiter	28 mm
Baubreite	61 mm
Bauhöhe	75,5 mm
Bautiefe gesamt	58 mm

Primärstrom [A]	Bürde [VA]	Sekundärstrom [A] / Klasse	
		5 A Kl. 1 Best.-Nr.	1 A Kl. 1 Best.-Nr.
200-100	5-2,5	8117	8317
300-150	5-2,5	8118	8318
	10-5	8119	8319
400-200	5-2,5	8120	8320
	10-5	8121	8321
500-250	5-2,5	8122	8322
	10-5	8123	8323
600-300	5-2,5	8124	8324
	10-5	8125	8325
	15-7,5	8126	8326

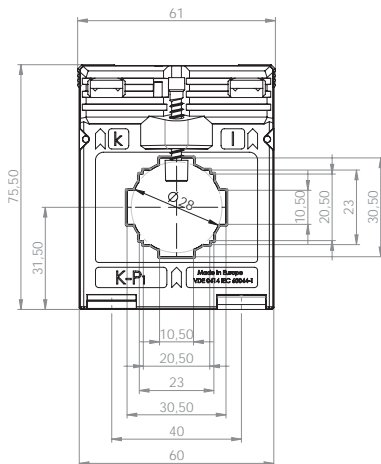

ASK 31.4 3U

Aufsteck-Stromwandler, sekundär umschaltbar

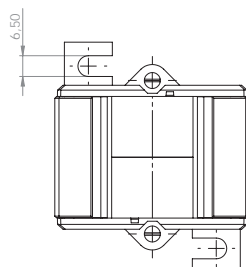
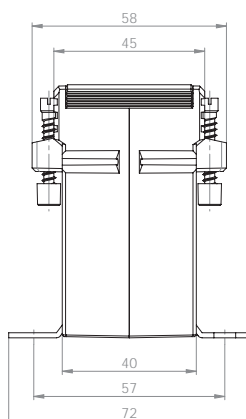

Primärstrom [A]	Bürde [VA]	Sekundärstrom [A] / Klasse	
		5 A Kl. 1 Best.-Nr.	1 A Kl. 1 Best.-Nr.
300-200-100	10-5-2,5	8137	8337
400-200-100	10-5-2,5	8138	8338
600-300-150	10-5-2,5	8139	8339
	15-10-5	8140	8340
600-400-200	10-5-2,5	8141	8341
	15-10-5	8142	8342

		Best.-Nr.
	Schnappbefestigung Form B	54011
	Plombierplatte Form B	59041



ASK 31.5

Aufsteck-Stromwandler



Schiene 1	30 x 10 mm
Schiene 2	2 x 20 x 10 mm
Rundleiter	28 mm
Baubreite	61 mm
Bauhöhe	75,5 mm
Bautiefe gesamt	68 mm

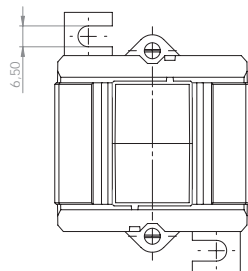
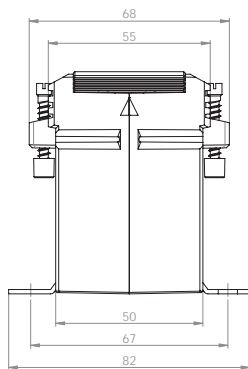
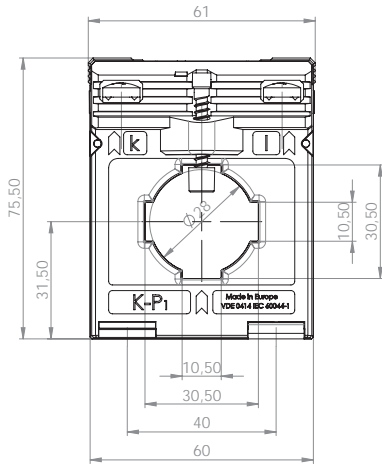

Primärstrom [A]	Bürde [VA]	Sekundärstrom [A] / Klasse			
		5 A Kl. 1 Best.-Nr.	5 A Kl. 0,5 Best.-Nr.	1 A Kl. 1 Best.-Nr.	1 A Kl. 0,5 Best.-Nr.
40	1	9043		9243	
50	1,5	9045		9245	
60	1,5	9047		9247	
	2,5	9048		9248	
75	1,5	9049	9011	9249	9211
	2,5	9050	9012	9250	9212
80	1,5	9051	9013	9251	9213
	2,5	9052	9014	9252	9214
100	1,5	9054	9015	9254	9215
	2,5	9055	9016	9255	9216
	5	9056	9017	9256	9217
150	2,5	9057	9018	9257	9218
	5	9058	9019	9258	9219
	7,5	9059		9259	
200	2,5	9060	9020	9260	9220
	5	9061	9021	9261	9221
	10	9062	9022	9262	9222
250	5	9064	9023	9264	9223
	10	9065	9024	9265	9224
	15	9066	9025	9266	9225
300	5	9067	9026	9267	9226
	10	9068	9027	9268	9227
	15	9069	9028	9269	9228
400	5	9070	9029	9270	9229
	10	9071	9030	9271	9230
	15	9072	9031	9272	9231
500	5	9074	9032	9274	9232
	10	9075	9033	9275	9233
	15	9076	9034	9276	9234
600	5	9078	9035	9278	9235
	10	9079	9036	9279	9236
	15	9080	9037	9280	9237
750	5	9082	9038	9282	9238
	10	9083	9039	9283	9239
	15	9084	9040	9284	9240

		Best.-Nr.
	Schnappbefestigung Form C	55011
	Plombierplatte Form B	59041

ASR

ASG

ASK

WSK

KBR / KBU

KSU / SUJK

NH

SASR / SASK

ASRD

ASKD / WSKD

CTB



ASK 31.5 2U

Aufsteck-Stromwandler, sekundär umschaltbar



Schiene 1	30 x 10 mm
Schiene 2	2 x 20 x 10 mm
Rundleiter	28 mm
Baubreite	61 mm
Bauhöhe	75,5 mm
Bautiefe gesamt	68 mm

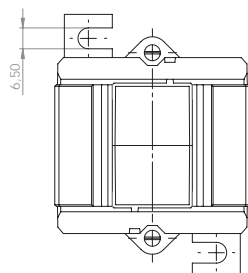
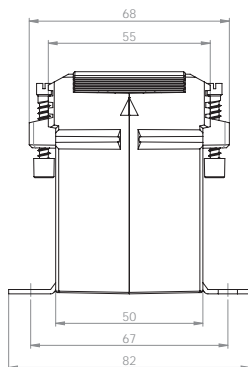
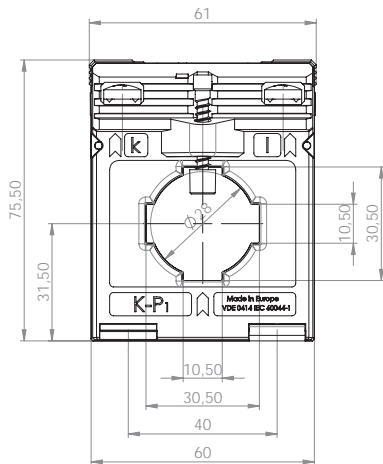

Primärstrom [A]	Bürde [VA]	Sekundärstrom [A] / Klasse	
		5 A Kl. 1 Best.-Nr.	1 A Kl. 1 Best.-Nr.
150-75	5-2,5	9132	9332
200-100	5-2,5	9133	9333
	10-5	9134	9334
300-150	5-2,5	9135	9335
	10-5	9136	9336
	15-7,5	9137	9337
400-200	5-2,5	9138	9338
	10-5	9139	9339
	15-7,5	9140	9340
500-250	5-2,5	9141	9341
	10-5	9142	9342
	15-7,5	9143	9343
600-300	5-2,5	9144	9344
	10-5	9145	9345
	15-7,5	9146	9346

		Best.-Nr.
	Schnappbefestigung Form C	55011
	Plombierplatte Form B	59041



ASK 31.6

Aufsteck-Stromwandler



- Schiene 1 30 x 10 mm
- Schiene 2 20 x 13 mm
- Rundleiter 23 mm
- Baubreite 95 mm
- Bauhöhe 116 mm
- Bautiefe gesamt 74 mm

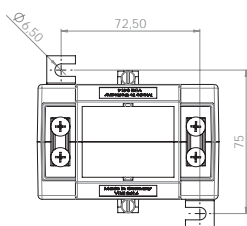
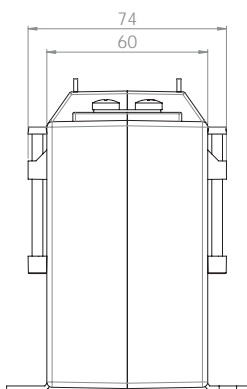
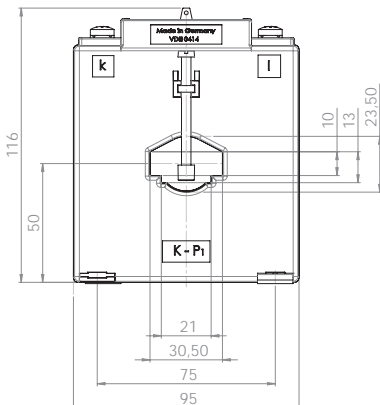

Primärstrom [A]	Bürde [VA]	Sekundärstrom [A] / Klasse			
		5 A Kl. 1 Best.-Nr.	5 A Kl. 0,5 Best.-Nr.	1 A Kl. 1 Best.-Nr.	1 A Kl. 0,5 Best.-Nr.
40	1,5	10056			
	2,5	10057			
50	1,5		10011		
	2,5	10058	10012		
60	1,5		10013		10213
	2,5	10059	10014	10259	10214
	3,75	10060		10260	
75	2,5	10061	10015	10261	10215
	5	10062	10016	10262	10216
80	2,5	10063	10017	10263	10217
	5	10064	10018	10264	10218
	10	10065		10265	
100	2,5	10066	10019	10266	10219
	5	10067	10020	10267	10220
	10	10068	10021	10268	10221
150	2,5		10022		10222
	5	10070	10023	10270	10223
	10	10071	10024	10271	10224
	15	10072	10025	10272	10225
200	2,5		10026		10226
	5	10073	10027	10273	10227
	10	10074	10028	10274	10228
	15	10075	10029	10275	10229
250	30	10120		10320	
	5	10076	10030	10276	10230
	10	10077	10031	10277	10231
	15	10078	10032	10278	10232
300	30	10124		10324	
	5	10079	10034	10279	10234
	10	10080	10035	10280	10235
	15	10081	10036	10281	10236
400	30	10125		10325	
	5	10082	10038	10282	10238
	10	10083	10039	10283	10239
	15	10084	10040	10284	10240
500	30	10406		10326	
	5	10085	10042	10285	10242
	10	10086	10043	10286	10243
	15	10087	10044	10287	10244
600	30	10121	10045	10321	10245
	5	10088	10046	10288	10246
	10	10089	10047	10289	10247
	15	10090	10048	10290	10248
750	30	10122	10049	10322	10249
	5	10091	10050	10291	10250
	10	10092	10051	10292	10251
	15	10093	10052	10293	10252
	30	10123	10053	10323	10253

		Best.-Nr.
	Schnappbefestigung	-
	Plombierplatte Form E	59044

ASR

ASG

ASK

WSK

KBR / KBU

KSU / SUJK

NH

SASR / SASK

ASRD

ASKD / WSKD

CTB



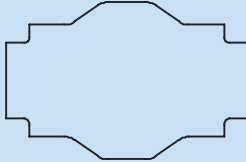
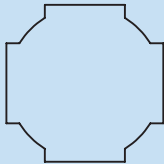
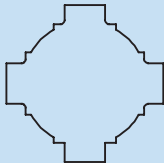
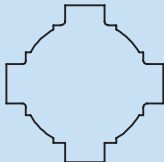
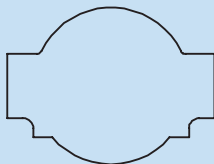
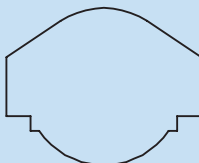

Aufsteck-Stromwandler

ASK 41.3	Primärleiter		40 x 12 mm
	Rundleiter Wandlerbreite		32 x 18 mm Ø 26 mm 61 mm
ASK 421.4	Primärleiter		20 x 10 mm
	Rundleiter Wandlerbreite		Ø 20 mm 71 mm
ASK 41.4	Primärleiter		40 x 10 mm
	ASK 41.4 2U ASK 41.4 3U		2 x 30 x 5 mm Ø 32 mm 71 mm
ASK 41.5	Primärleiter		40 x 10 mm
	Rundleiter Wandlerbreite		Ø 32 mm 71 mm
ASK 412.4	Primärleiter		40 x 12 mm
	ASK 412.4 2U ASK 412.4 3U		30 x 15 mm Ø 30,5 mm 71 mm
ASK 41.6	Primärleiter		40 x 12 mm
	Rundleiter Wandlerbreite		30 x 15 mm Ø 32 mm 95 mm



ASK 41.3

Aufsteck-Stromwandler



Schiene 1	40 x 12 mm
Schiene 2	32 x 18 mm
Rundleiter	26 mm
Baubreite	61 mm
Bauhöhe	75,5 mm
Bautiefe gesamt	48 mm

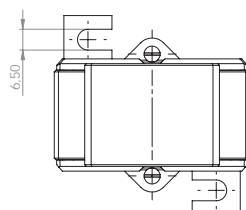
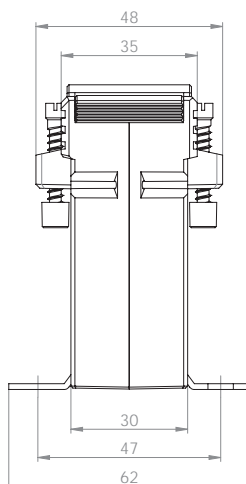
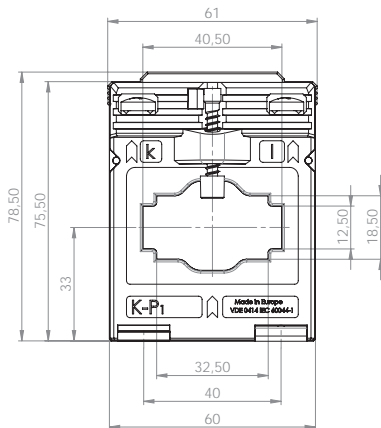

Primärstrom [A]	Bürde [VA]	Sekundärstrom [A] / Klasse	
		5 A Kl. 1 Best.-Nr.	1 A Kl. 1 Best.-Nr.
100	1	11037	11237
	1,5	11038	11238
150	1,5	11039	11239
	2,5	11040	11240
200	1,5	11041	11241
	2,5	11042	11242
250	1,5	11043	11243
	2,5	11044	11244
300	1,5	11046	11246
	2,5	11047	11247
	5	11048	11248
400	1,5	11049	
	2,5	11050	
	5	11051	
500	1,5	11052	
	2,5	11053	
	5	11054	
600	1,5	11056	
	2,5	11057	
	5	11058	
750	2,5	11060	
	5	11061	
	10	11062	

		Best.-Nr.
	Schnappbefestigung Form A	53011
	Plombierplatte Form A	59040



ASK 421.4

Aufsteck-Stromwandler



Schiene 1	20 x 10 mm
Rundleiter	20 mm
Baubreite	71 mm
Bauhöhe	85,5 mm
Bautiefe gesamt	58 mm

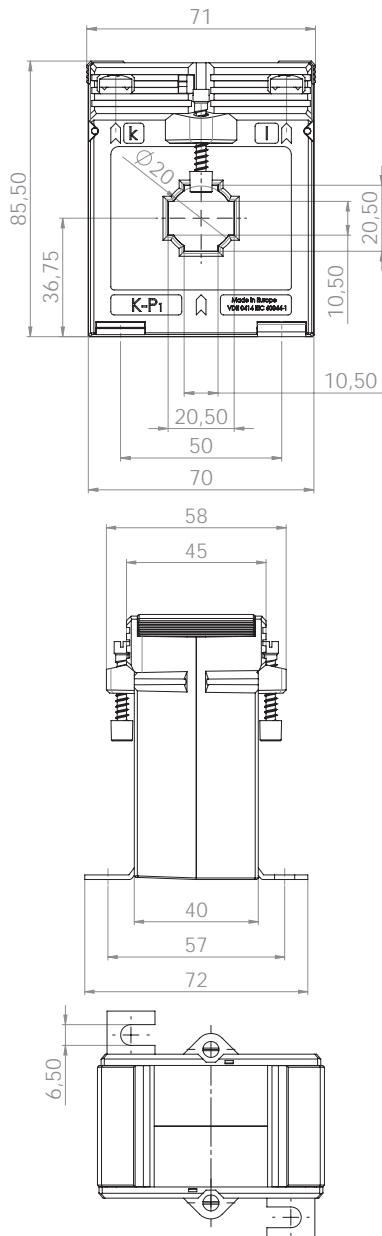

Primärstrom [A]	Bürde [VA]	Sekundärstrom [A] / Klasse			
		5 A Kl. 1 Best.-Nr.	5 A Kl. 0,5 Best.-Nr.	1 A Kl. 1 Best.-Nr.	1 A Kl. 0,5 Best.-Nr.
40	1,5	12034		12234	
50	1,5	12035	12011	12235	12211
	2,5	12036		12236	
60	1,5	12037	12012	12237	12212
	2,5	12038		12238	
75	1,5		12009		12209
	2,5	12040	12013	12240	12213
	3,75	12069		12269	
80	1,5		12010		12210
	2,5	12042	12014	12242	12214
	3,75	12068		12268	
	5			12243	
100	2,5	12044	12015	12244	12215
	5	12045		12245	
125	2,5	12047	12017	12247	12217
	5	12048	12018	12248	12218
150	2,5	12112	12019	12293	12219
	5	12050	12020	12250	12220
	10	12051		12251	
	2,5	12276	12021	12294	12221
200	5	12053	12022	12253	12222
	10	12054		12254	
	15	12055		12255	
250	5	12056	12023	12256	12223
	10	12057	12024	12257	12224
	15	12058		12258	
300	5	12059	12025	12259	12225
	10	12060	12026	12260	12226
	15	12061		12261	
400	5	12113	12027	12295	12227
	10	12062	12028	12262	12228
	15	12063	12029	12263	12229
500	5	12280	12030	12296	12230
	10	12065	12031	12265	12231
	15	12066	12032	12266	12232

		Best.-Nr.
	Schnappbefestigung Form D	55012
	Plombierplatte Form B	59041



ASK 41.4

Aufsteck-Stromwandler



Schiene 1	40 x 10 mm
Schiene 2	2 x 30 x 5 mm
Rundleiter	32 mm
Baubreite	71 mm
Bauhöhe	85,5 mm
Bautiefe gesamt	58 mm

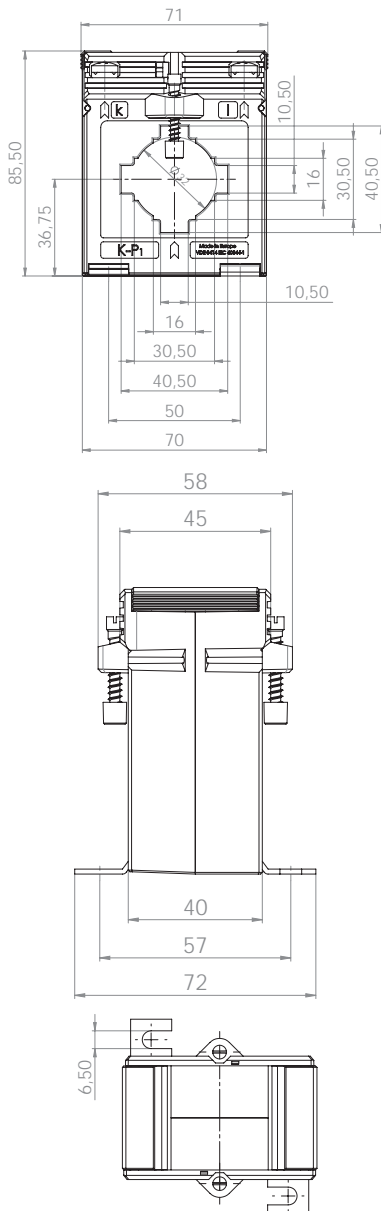

Primärstrom [A]	Bürde [VA]	Sekundärstrom [A] / Klasse				
		5 A Kl. 1 Best.-Nr.	5 A Kl. 0,5 Best.-Nr.	5 A Kl. 0,2s Best.-Nr.	1 A Kl. 1 Best.-Nr.	1 A Kl. 0,5 Best.-Nr.
50	1,25	13180				
	1,5	13036				
60	1,25	13181				
	1,5	13037				
75	1,5	13039			13239	
	2,5	13040			13240	
80	1,5	13041			13241	
	2,5	13042			13242	
100	1,5	13043	13011		13243	13211
	2,5	13044	13083		13244	13283
	3,75	13179			13245	
150	1,5	13046	13012	V24-1604C	13246	13212
	2,5	13047	13013		13247	13213
	5	13048			13248	
200	1,5		13014	V24-1704C		13214
	2,5	13049	13015	V24-1704D	13249	13215
	5	13050	13085		13250	13285
	10	13051			13251	
250	1,5		13016	V24-1804C		13216
	2,5	13052	13017	V24-1804D	13252	13217
	5	13053	13086	V24-1804F	13253	13286
	10	13054			13254	
300	2,5	13055	13018	V24-1904D	13255	13218
	5	13056	13019	V24-1904F	13256	13219
	10	13057	13087		13257	13287
400	15	13058			13258	
	2,5	13059	13020	V24-2004D	13259	13220
	5	13060	13021	V24-2004F	13260	13221
	10	13061	13088	V24-2004H	13261	13288
500	15	13062			13262	
	2,5	13063	13022	V24-2104D	13263	13222
	5	13064	13023	V24-2104F	13264	13223
	10	13065	13024	V24-2104H	13265	13224
600	15	13066	13089		13266	13289
	2,5	13067	13025	V24-2204D	13267	13225
	5	13068	13026	V24-2204F	13268	13226
	10	13069	13027		13269	13227
750	15	13070	13090		13270	
	2,5			V24-2304D		
	5	13071	13028	V24-2304F	13271	13228
	10	13072	13029	V24-2304H	13272	13229
800	15	13073			13273	13291
	5	13075	13030		13275	13230
	10	13076	13031		13276	13231
1000	15	13077			13277	
	5	13079	13032		13279	13232
	10	13080	13033		13280	13233

		Best.-Nr.
	Schnappbefestigung Form D	55012
	Plombierplatte Form B	59041



ASK 41.4 2U

Aufsteck-Stromwandler, sekundär umschaltbar



Schiene 1	40 x 10 mm
Schiene 2	2 x 30 x 5 mm
Rundleiter	32 mm
Baubreite	71 mm
Bauhöhe	85,5 mm
Bautiefe gesamt	58 mm

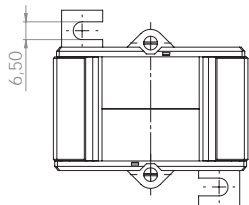
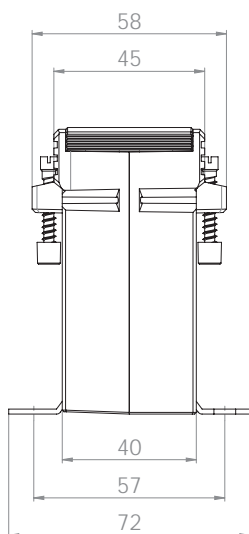
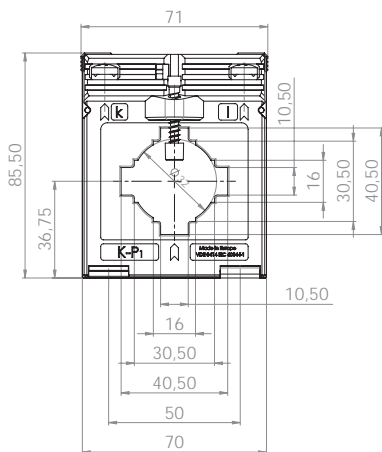

Primärstrom [A]	Bürde [VA]	Sekundärstrom [A] / Klasse	
		5 A Kl. 1 Best.-Nr.	1 A Kl. 1 Best.-Nr.
200-100	5-2,5	13133	13333
300-150	5-2,5	13134	13334
	10-5	13135	13335
400-200	5-2,5	13136	13336
	10-5	13137	13337
500-250	5-2,5	13138	13338
	10-5	13139	13339
600-300	5-2,5	13140	13340
	10-5	13141	13341
800-400	5-2,5	13142	13342
	10-5	13143	13343
	15-7,5	13144	13344
1000-500	5-2,5	13145	13345
	10-5	13146	13346
	15-7,5	13147	13347

ASK 41.4 3U

Aufsteck-Stromwandler, sekundär umschaltbar

Primärstrom [A]	Bürde [VA]	Sekundärstrom [A] / Klasse	
		5 A Kl. 1 Best.-Nr.	1 A Kl. 1 Best.-Nr.
400-200-100	10-5-2,5	13163	13363
600-300-150	10-5-2,5	13164	13364
800-400-200	10-5-2,5	13165	13365
1000-500-250	10-5-2,5	13166	13366
	15-7,5-2,5	13167	13367

		Best.-Nr.
	Schnappbefestigung Form D	55012
	Plombierplatte Form B	59041



ASK 41.5

Aufsteck-Stromwandler



Schiene 1	40 x 10 mm
Schiene 2	2 x 30 x 5 mm
Rundleiter	32 mm
Baubreite	71 mm
Bauhöhe	85,5 mm
Bautiefe gesamt	68 mm

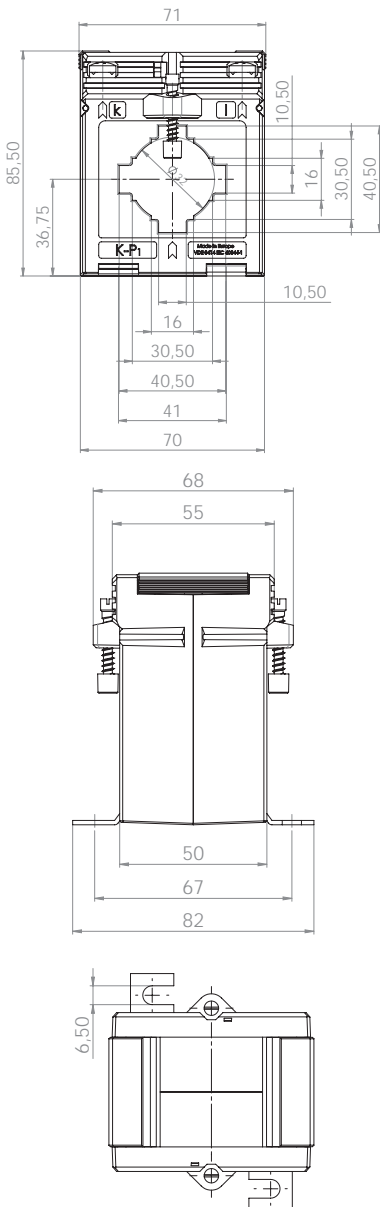

Primärstrom [A]	Bürde [VA]	Sekundärstrom [A] / Klasse			
		5 A Kl. 1 Best.-Nr.	5 A Kl. 0,5 Best.-Nr.	1 A Kl. 1 Best.-Nr.	1 A Kl. 0,5 Best.-Nr.
60	1,5	1010006002		1010206002	
75	1,5	1010006004	1010005001	1010206004	1010205001
	2,5	1010006005	1010005002	1010206005	1010205002
80	1,5	1010006006	1010005003	1010206006	1010205003
	2,5	1010006007	1010005004	1010206007	1010205004
100	1,5	1010006008	1010005005	1010206008	1010205005
	2,5	1010006009	1010005006	1010206009	1010205006
	3,75	1010006046		1010206010	
150	2,5	1010006010	1010005007	1010206011	1010205007
	5	1010006011		1010206012	
	7,5	1010006012		1010206013	
200	2,5	1010006013	1010005010	1010206014	1010205010
	5	1010006014	1010005011	1010206015	1010205011
	10	1010006048		1010206016	
250	2,5	1010006015	1010005012	1010206017	1010205013
	5	1010006016	1010005013	1010206018	1010205014
	10	1010006017	1010005014	1010206019	1010205015
	15	1010006047		1010206020	
300	2,5	1010006018	1010005015	1010206021	1010205017
	5	1010006019	1010005016	1010206022	1010205018
	10	1010006020	1010005017	1010206023	1010205019
	15	1010006021		1010206024	
400	2,5	1010006022	1010005019	1010206025	1010205021
	5	1010006023	1010005020	1010206026	1010205022
	10	1010006024	1010005021	1010206027	1010205023
	15	1010006025	1010005022	1010206028	1010205024
500	2,5	1010006026	1010005023	1010206029	1010205025
	5	1010006027	1010005024	1010206030	1010205026
	10	1010006028	1010005025	1010206031	1010205027
	15	1010006029	1010005026	1010206032	1010205028
600	2,5	1010006030	1010005027	1010206033	1010205029
	5	1010006031	1010005028	1010206034	1010205030
	10	1010006032	1010005029	1010206035	1010205031
	15	1010006033	1010005030	1010206036	1010205032
750	2,5	1010006034	1010005031	1010206037	1010205033
	5	1010006035	1010005032	1010206038	1010205034
	10	1010006036	1010005033	1010206039	1010205035
	15	1010006037	1010005034	1010206040	1010205036
800	2,5	1010006038	1010005035	1010206041	1010205037
	5	1010006039	1010005036	1010206042	1010205038
	10	1010006040	1010005037	1010206043	1010205039
	15	1010006041		1010206044	
1000	2,5	1010006042	1010005039	1010206045	1010205041
	5	1010006043	1010005040	1010206046	1010205042
	10	1010006044	1010005041	1010206047	1010205043
	15	1010006045		1010206048	

		Best.-Nr.
	Schnappbefestigung Form C	55011
	Plombierplatte Form B	59041



MBS AG



ASK 412.4

Aufsteck-Stromwandler



Schiene 1	40 x 12 mm
Schiene 2	30 x 15 mm
Rundleiter	30,5 mm
Baubreite	71 mm
Bauhöhe	85,5 mm
Bautiefe gesamt	58 mm

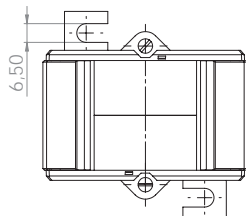
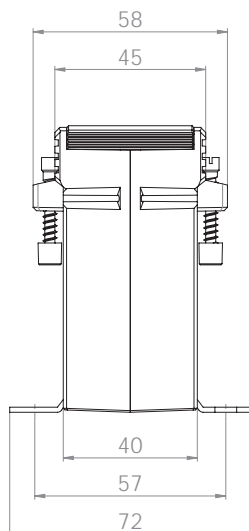
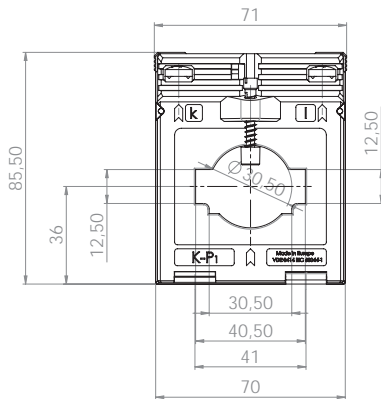

Primärstrom [A]	Bürde [VA]	Sekundärstrom [A] / Klasse			
		5 A Kl. 1 Best.-Nr.	5 A Kl. 0,5 Best.-Nr.	1 A Kl. 1 Best.-Nr.	1 A Kl. 0,5 Best.-Nr.
50	1,25	28036		28236	
	1,5	28037		28237	
60	1,25	28038		28238	
	1,5	28039		28239	
75	1,5	28040		28240	
	2,5	28041		28241	
80	1,5	28042		28242	
	2,5	28043		28243	
100	1,5	28044	28011	28244	28211
	2,5	28045		28245	
	3,75	28046		28246	
150	1,5	28047	28012	28247	28212
	2,5	28048	28013	28248	28213
	5	28049		28249	
200	2,5	28051	28015	28251	28215
	5	28052	28098	28252	28298
	7,5	28086		28286	
	10	28053			
250	1,5	28054	28016	28254	28216
	2,5	28055	28017	28255	28217
	5	28056	28014	28256	28214
	10	28057		28257	
300	2,5	28058	28018	28258	28218
	5	28059	28019	28259	28219
	10	28060		28260	
	15	28061		28261	
400	2,5	28062	28020	28262	28220
	5	28063	28021	28263	28221
	10	28064	28009	28264	28209
	15	28065		28265	
500	2,5	28066	28022	28266	28222
	5	28067	28023	28267	28223
	10	28068	28024	28268	28224
	15	28069		28269	
600	2,5	28070	28025	28270	28225
	5	28071	28026	28271	28226
	10	28072	28027	28272	28227
	15	28073		28273	
750	5	28074	28028	28274	28228
	10	28075	28029	28275	28229
	15	28076	28010	28276	28210
800	5	28078	28030	28278	28230
	10	28079	28031	28279	28231
	15	28080	28035	28280	28235

		Best.-Nr.
	Schnappbefestigung Form D	55012
	Plombierplatte Form B	59041



ASK 412.4 2U

Aufsteck-Stromwandler, sekundär umschaltbar



Schiene 1	40 x 12 mm
Schiene 2	30 x 15 mm
Rundleiter	30,5 mm
Baubreite	71 mm
Bauhöhe	85,5 mm
Bautiefe gesamt	58 mm

Primärstrom [A]	Bürde [VA]	Sekundärstrom [A] / Klasse	
		5 A Kl. 1 Best.-Nr.	1 A Kl. 1 Best.-Nr.
200-100	5-2,5	28133	28333
300-150	5-2,5	28134	28334
	10-5	28135	28335
400-200	5-2,5	28136	28336
	10-5	28137	28337
500-250	5-2,5	28138	28338
	10-5	28139	28339
600-300	5-2,5	28140	28340
	10-5	28141	28341
800-400	5-2,5	28143	28343
	10-5	28144	28344
	15-7,5	28145	28345

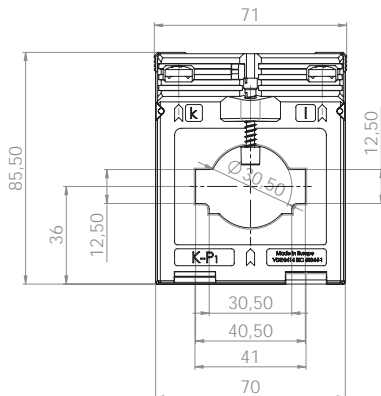

ASK 412.4 3U

Aufsteck-Stromwandler, sekundär umschaltbar

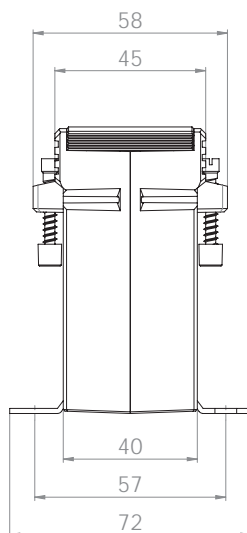

Primärstrom [A]	Bürde [VA]	Sekundärstrom [A] / Klasse	
		5 A Kl. 1 Best.-Nr.	1 A Kl. 1 Best.-Nr.
400-200-100	10-5-2,5	28163	28363
600-300-150	10-5-2,5	28164	28364
800-400-200	10-5-2,5	28165	28365

		Best.-Nr.
	Schnappbefestigung Form D	55012
	Plombierplatte Form B	59041



ASK 41.6

Aufsteck-Stromwandler



- Schiene 1 40 x 12 mm
- Schiene 2 30 x 15 mm
- Rundleiter 32 mm
- Baubreite 95 mm
- Bauhöhe 116 mm
- Bautiefe gesamt 74 mm

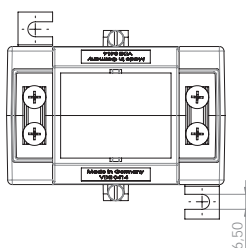
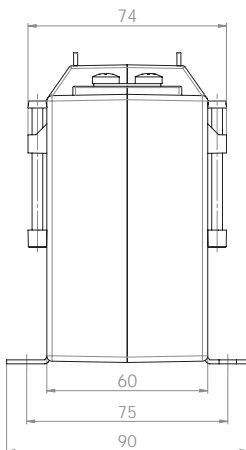
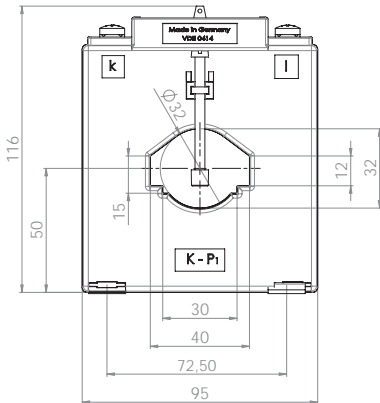

Primärstrom [A]	Bürde [VA]	Sekundärstrom [A] / Klasse			
		5 A Kl. 1 Best.-Nr.	5 A Kl. 0,5 Best.-Nr.	1 A Kl. 1 Best.-Nr.	1 A Kl. 0,5 Best.-Nr.
50	1,5	14060	14011	14260	14211
60	1,5	14062	14012	14262	14212
	2,5	14063		14263	
75	1,5	14064		14264	
	2,5	14065	14013	14265	14213
80	3,75	14134		14334	
	2,5	14067	14015	14267	14215
100	3,75	14135		14335	
	2,5	14069	14017	14269	14217
100	5	14070	14018	14270	14218
	7,5	14136		14336	
150	5	14072	14021	14272	14221
	10	14073		14273	
	15	14074		14274	
200	5	14075	14025	14275	14225
	10	14076	14026	14276	14226
	15	14077		14277	
250	5	14078	14029	14278	14229
	10	14079	14030	14279	14230
	15	14080	14031	14280	14231
300	5	14081	14033	14281	14233
	10	14082	14034	14282	14234
	15	14083	14035	14283	14235
400	5	14084	14037	14284	14237
	10	14085	14038	14285	14238
	15	14086	14039	14286	14239
500	5	14087	14041	14287	14241
	10	14088	14042	14288	14242
	15	14089	14043	14289	14243
	30	14137		14337	
600	10	14090	14045	14290	14245
	15	14091	14046	14291	14246
	30	14092	14047	14292	14247
750	10	14094	14049	14294	14249
	15	14095	14050	14295	14250
	30	14096	14051	14296	14251
800	10	14098	14053	14298	14253
	15	14099	14054	14299	14254
	30	14100	14055	14300	14255
1000	10	14102	14057	14302	14257
	15	14103	14058	14303	14258
	30	14104	14059	14304	14259

	Schnappbefestigung	Best.-Nr. -
	Plombierplatte Form E	59044

ASR

ASG

ASK

WSK

KBR / KBU

KSU / SJSK

NH

SASR / SASK

ASRD

ASKD / WSKD

CTB



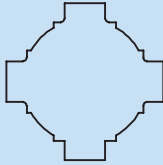
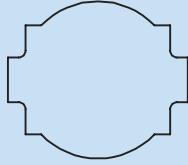
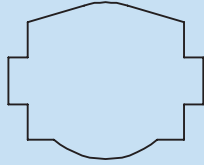
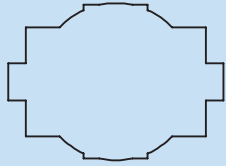

Aufsteck-Stromwandler

ASK 541.4	Primärleiter		40 x 10 mm
	Rundleiter Wandlerbreite		2 x 30 x 5 mm Ø 32 mm 86 mm
ASK 51.4 ASK 51.4 2U ASK 51.4 3U	Primärleiter		50 x 12 mm
	Rundleiter Wandlerbreite		2 x 40 x 10 mm Ø 44 mm 86 mm
ASK 51.6	Primärleiter		50 x 12 mm
	Rundleiter Wandlerbreite		40 x 30 mm Ø 40 mm 95 mm
ASK 561.4	Primärleiter		60 x 10 mm
	Rundleiter Wandlerbreite		30 x 40 mm 2 x 50 x 10 mm Ø 44 mm 86 mm



ASK 541.4

Aufsteck-Stromwandler



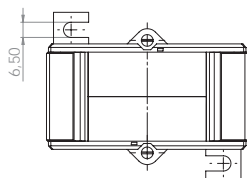
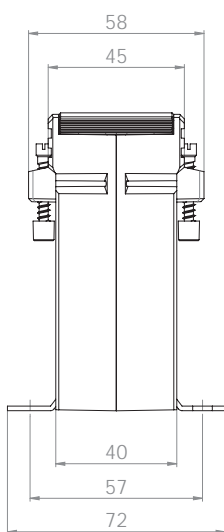
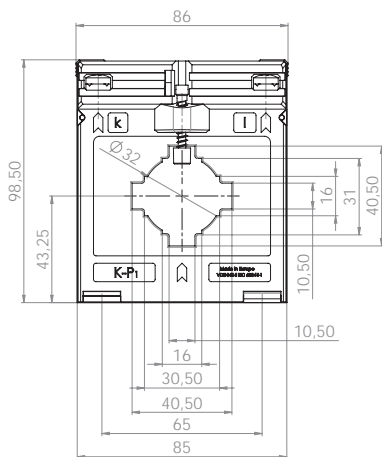

Schiene 1	40 x 10 mm
Schiene 2	2 x 30 x 5 mm
Rundleiter	32 mm
Baubreite	86 mm
Bauhöhe	98,5 mm
Bautiefe gesamt	58 mm



Primärstrom [A]	Bürde [VA]	Sekundärstrom [A] / Klasse				
		5 A Kl. 1 Best.-Nr.	5 A Kl. 0,5 Best.-Nr.	5 A Kl. 0,2s Best.-Nr.	1 A Kl. 1 Best.-Nr.	1 A Kl. 0,5 Best.-Nr.
30	1	15340			15248	
	1,5	15048				
40	1,5	15049			15249	
50	1,5	15051			15251	
	2,5	15053	15013		15253	15213
60	1,5	15054			15254	
	2,5	15055	15014		15255	15214
75	1,5	15056	15100		15256	15300
	2,5	15057	15016		15257	15216
80	2,5	15114	15017		15314	15217
	5	15059				
100	2,5		15019			15219
	5	15061			15261	
125	2,5	15063	15021		15263	15221
	5	15064			15264	
	10	15065			15265	
150	2,5		15023	V33-1704D		15223
	5	15066	15024	V33-1704F	15266	15224
	10	15067	15101		15267	15301
	15	15068	15102		15268	15302
200	2,5		15025	V33-1804D		15225
	5	15069	15026	V33-1804F	15269	15226
	10	15070	15103	V33-1804H	15270	15303
	15	15071	15104		15271	15304
250	2,5		15027	V33-1904D		15227
	5	15072	15028	V33-1904F	15272	15228
	10	15073	15029	V33-1904H	15273	15229
	15	15074	15105		15274	15305
300	2,5		15030	V33-2004D		15230
	5	15075	15031	V33-2004F	15275	15231
	10	15076	15032	V33-2004H	15276	15232
	15	15077	15139		15277	15339
400	2,5			V33-2104D		
	5	15098	15033	V33-2104F	15313	15233
	10	15078	15034	V33-2104H	15278	15234
	15	15079	15035	V33-2104J	15279	15235
500	30	15080			15280	
	2,5			V33-2204D		
	5	15095	15036	V33-2204F	15293	15236
	10	15081	15037	V33-2204H	15281	15237
600	15	15082	15038	V33-2204J	15282	15238
	30	15083	15039		15283	15239
	2,5			V33-2304D		
750	5			V33-2304F		
	10	15084	15040	V33-2304H	15284	15240
	15	15085	15041	V33-2304J	15285	15241
	30	15086	15042		15286	15242



Primärstrom [A]	Bürde [VA]	Sekundärstrom [A] / Klasse				
		5 A Kl. 1 Best.-Nr.	5 A Kl. 0,5 Best.-Nr.	5 A Kl. 0,2s Best.-Nr.	1 A Kl. 1 Best.-Nr.	1 A Kl. 0,5 Best.-Nr.
800	10	15087	15043		15287	15243
	15	15088	15044		15288	15244
	30	15089	15106		15289	15306
1000	2,5			V33-2504D		
	5		15045	V33-2504F		15245
	10	15090	15046	V33-2504H	15290	15246
	15	15091	15047	V33-2504J	15291	15247
	30	15092	15012		15292	

		Best.-Nr.
	Schnappbefestigung	-
	Plombierplatte Form C	59042



ASK 51.4

Aufsteck-Stromwandler



Schiene 1	50 x 12 mm
Schiene 2	2 x 40 x 10 mm
Rundleiter	44 mm
Baubreite	86 mm
Bauhöhe	98,5 mm
Bautiefe gesamt	58 mm

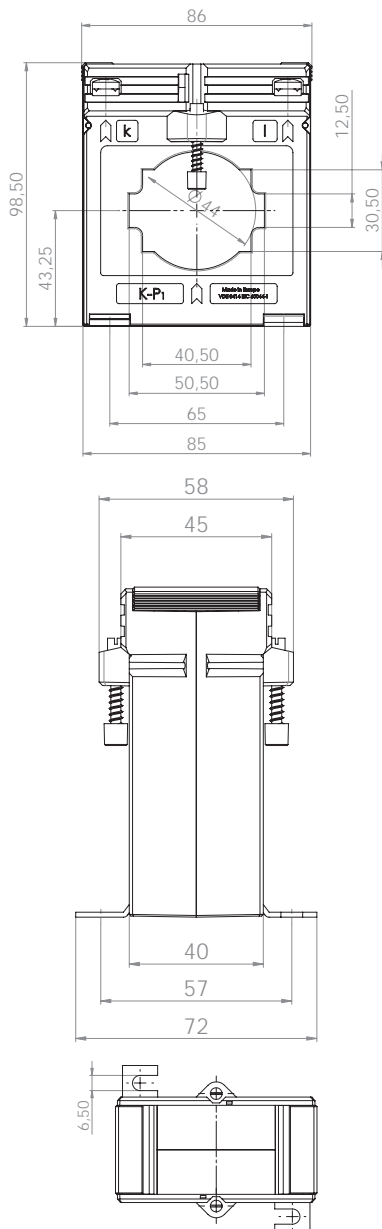

Primärstrom [A]	Bürde [VA]	Sekundärstrom [A] / Klasse				
		5 A Kl. 1 Best.-Nr.	5 A Kl. 0,5 Best.-Nr.	5 A Kl. 0,2s Best.-Nr.	1 A Kl. 1 Best.-Nr.	1 A Kl. 0,5 Best.-Nr.
100	1,5	16043			16243	
150	1,5	16044	16011		16244	16211
	2,5	16045	16010		16245	16210
200	1,5		16012	V34-1704C		16212
	2,5	16046	16013	V34-1704D	16246	16213
	5	16047	16152	V34-1704F	16247	16352
250	1,5		16014			16214
	2,5	16048	16015	V34-1804D	16248	16215
	5	16049	16153	V34-1804F	16249	16353
300	10	16177			16390	
	2,5	16050	16017	V34-1904D	16250	16217
	5	16051	16018	V34-1904F	16251	16218
400	10	16052			16252	
	2,5	16053	16019	V34-2004D	16253	16219
	5	16054	16020	V34-2004F	16254	16220
	10	16055	16021	V34-2004H	16255	16221
500	15				16256	
	2,5	16057	16022	V34-2104D	16257	16222
	5	16058	16023	V34-2104F	16258	16223
	10	16059	16024	V34-2104H	16259	16224
600	15	16060	16202		16260	
	2,5	16061	16025	V34-2204D	16261	16225
	5	16062	16026	V34-2204F	16262	16226
	10	16063	16027	V34-2204H	16263	16227
750	15	16064	16154		16264	16354
	2,5	16065	16028	V34-2304D	16265	16228
	5	16066	16029	V34-2304F	16266	16229
	10	16067	16030	V34-2304H	16267	16230
800	15	16068	16203		16268	16355
	5	16069	16031	V34-2404F	16269	16231
	10	16070	16032	V34-2404H	16270	16232
	15	16071	16033		16271	16233
1000	2,5			V34-2504D		
	5	16073	16034	V34-2504F	16273	16234
	10	16074	16035	V34-2504H	16274	16235
	15	16075	16036	V34-2504J	16275	16236
1200	30	16076			16276	
	5	16077	16037		16277	16237
	10	16078	16038		16278	16238
	15	16079	16039		16279	16239
1250	30	16080			16280	
	5	16081	16040		16281	16240
	10	16082	16041		16282	16241
	15	16083	16042		16283	16242
	30	16084			16284	

		Best.-Nr.
	Schnappbefestigung	–
	Plombierplatte Form C	59042



MBS AG



ASK 51.4 2U

Aufsteck-Stromwandler, sekundär umschaltbar



Schiene 1	50 x 12 mm
Schiene 2	2 x 40 x 10 mm
Rundleiter	44 mm
Baubreite	86 mm
Bauhöhe	98,5 mm
Bautiefe gesamt	58 mm

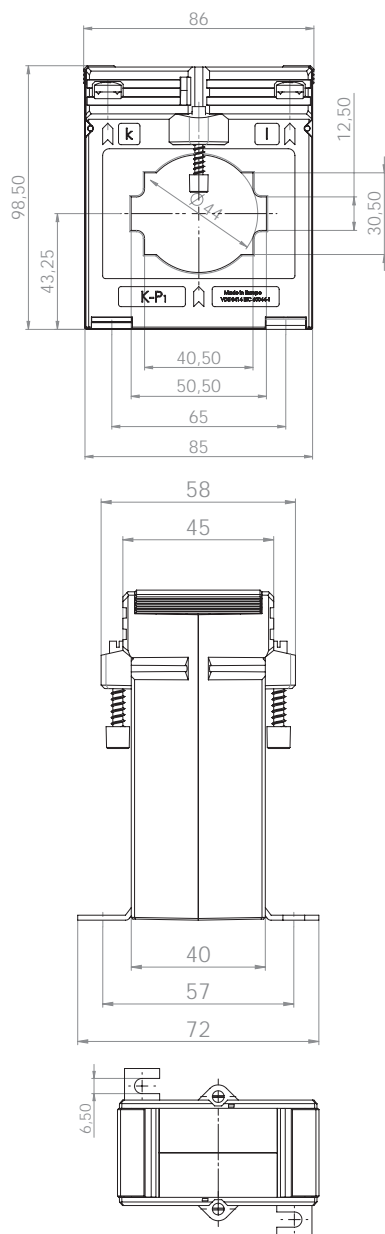

Primärstrom [A]	Bürde [VA]	Sekundärstrom [A] / Klasse	
		5 A Kl. 1 Best.-Nr.	1 A Kl. 1 Best.-Nr.
400-200	5-2,5	16130	16330
	10-5	16131	16331
500-250	5-2,5	16132	16332
	10-5	16133	16333
600-300	5-2,5	16134	16334
	10-5	16135	16335
800-400	5-2,5	16136	16336
	10-5	16137	16337
	15-7,5	16138	16338
1000-500	5-2,5	16139	16339
	10-5	16140	16340
	15-7,5	16141	16341
1200-600	5-2,5	16142	16342
	10-5	16143	16343
	15-7,5	16144	16344
	30-15	16145	16345

ASK 51.4 3U

Aufsteck-Stromwandler, sekundär umschaltbar

Primärstrom [A]	Bürde [VA]	Sekundärstrom [A] / Klasse	
		5 A Kl. 1 Best.-Nr.	1 A Kl. 1 Best.-Nr.
600-400-200	15-7,5-5	16178	16378
800-400-200	10-5-2,5	16162	16362
1000-500-250	10-5-2,5	16163	16363
	15-7,5-2,5	16164	16364
1000-600-300	10-5-2,5	16180	16380
	15-10-5	16176	16376
1000-600-400	10-5-2,5	16175	16375
1000-800-600	15-10-5	16179	16379
1200-600-300	10-5-2,5	16165	16365
	15-7,5-2,5	16166	16366
1200-1000-300	7,5-5-2,5	16174	16374

		Best.-Nr.
	Schnappbefestigung	-
	Plombierplatte Form C	59042



ASK 51.6

Aufsteck-Stromwandler



- Schiene 1 50 x 12 mm
- Schiene 2 40 x 30 mm
- Rundleiter 40 mm
- Baubreite 95 mm
- Bauhöhe 116 mm
- Bautiefe gesamt 74 mm

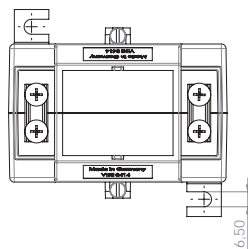
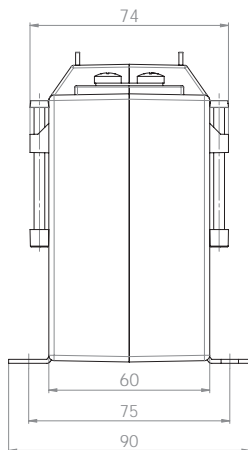
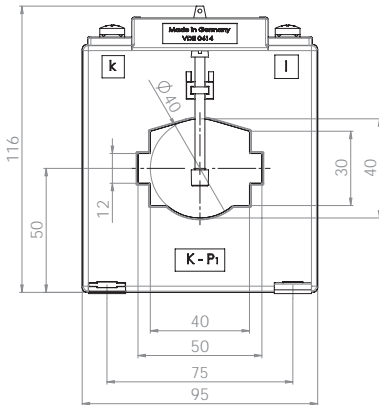

Primärstrom [A]	Bürde [VA]	Sekundärstrom [A] / Klasse			
		5 A Kl. 1 Best.-Nr.	5 A Kl. 0,5 Best.-Nr.	1 A Kl. 1 Best.-Nr.	1 A Kl. 0,5 Best.-Nr.
100	2,5	17058		17258	
	5	17059		17259	
150	2,5	17060	17013	17260	17213
	5	17061	17014	17261	17214
	10	17062		17262	
200	2,5	17063	17016	17263	17216
	5	17064	17017	17264	17217
	10	17065	17018	17265	17218
250	2,5	17066	17019	17266	17219
	5	17067	17020	17267	17220
	10	17068	17021	17268	17221
	15	17069	17022	17269	17222
300	5	17070	17024	17270	17224
	10	17071	17025	17271	17225
	15	17072	17026	17272	17226
	30	17073		17273	
400	5	17074	17028	17274	17228
	10	17075	17029	17275	17229
	15	17076	17030	17276	17230
	30	17077		17277	
500	5	17078	17032	17278	17232
	10	17079	17033	17279	17233
	15	17080	17034	17280	17234
	30	17081		17281	
600	5	17082	17036	17282	17236
	10	17083	17037	17283	17237
	15	17084	17038	17284	17238
	30	17085		17285	
750	5	17086	17040	17286	17240
	10	17087	17041	17287	17241
	15	17088	17042	17288	17242
	30	17089		17289	
800	10	17090	17044	17290	17244
	15	17091	17045	17291	17245
	30	17092		17292	
	45	17093		17293	
1000	10	17094	17047	17294	17247
	15	17095	17048	17295	17248
	30	17096	17049	17296	17249
	45	17097		17297	
1200	10	17098	17051	17298	17251
	15	17099	17052	17299	17252
	30	17100	17053	17300	17253
	45	17101		17301	
1250	10	17102	17055	17302	17255
	15	17103	17056	17303	17256
	30	17104	17057	17304	17257
	45	17105		17305	

		Best.-Nr.
	Schnappbefestigung	-
	Plombierplatte Form E	59044



ASK 561.4

Aufsteck-Stromwandler



Schiene 1	60 x 10 mm
Schiene 2	30 x 40 mm
Schiene 3	2 x 50 x 10 mm
Rundleiter	44 mm
Baubreite	86 mm
Bauhöhe	98,5 mm
Bautiefe gesamt	58 mm

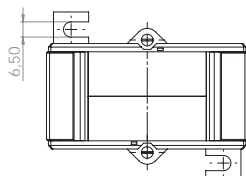
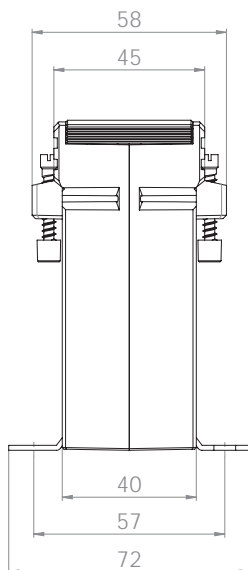
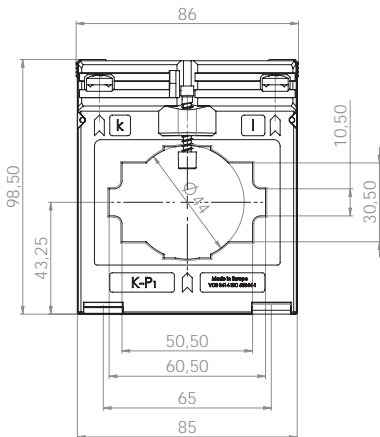

Primärstrom [A]	Bürde [VA]	Sekundärstrom [A] / Klasse			
		5 A Kl. 1 Best.-Nr.	5 A Kl. 0,5 Best.-Nr.	1 A Kl. 1 Best.-Nr.	1 A Kl. 0,5 Best.-Nr.
200	2,5	18036		18236	
250	2,5	18037		18237	
	5	18038		18238	
300	2,5	18039	18012	18239	18212
	5	18040		18240	
400	2,5	18042	18014	18242	18214
	5	18043	18015	18243	18215
	10	18044		18244	
500	2,5		18016		18216
	5	18045	18017	18245	18217
	10	18046		18246	
	15	18047		18247	
600	2,5		18018		18218
	5	18048	18019	18248	18219
	10	18049	18020	18249	18220
	15	18050		18250	
750	2,5		18021		18221
	5	18051	18022	18251	18222
	10	18052	18023	18252	18223
	15	18053		18253	
800	5	18097	18024	18297	18224
	10	18054	18025	18254	18225
	15	18055	18026	18255	18226
1000	5	18104	18027	18304	18227
	10	18057	18028	18257	18228
	15	18058	18029	18258	18229
	30	18059		18259	
1200	5	18100	18030	18267	18230
	10	18060	18031	18260	18231
	15	18061	18032	18261	18232
	30	18062		18262	
1250	5	18102	18033	18302	18233
	10	18063	18034	18263	18234
	15	18064	18035	18264	18235

		Best.-Nr.
	Schnappbefestigung	-
	Plombierplatte Form C	59042

ASR

ASG

ASK

WSK

KBR / KBU

KSU / SUJK

NH

SASR / SASK

ASRD

ASKD / WSKD

CTB





MBS AG



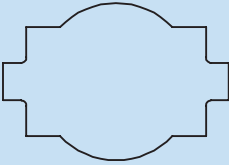
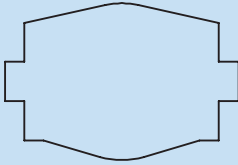
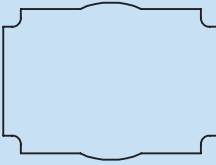
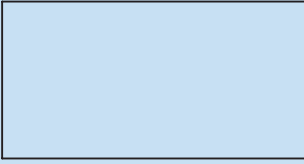
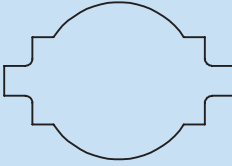

Aufsteck-Stromwandler

ASK 61.4 ASK 61.4 2U ASK 61.4 3U	Primärleiter		63 x 10 mm
	Rundleiter		2 x 50 x 10 mm
	Wandlerbreite		Ø 44 mm 96 mm
ASK 61.6	Primärleiter		60 x 10 mm
	Rundleiter		50 x 30 mm
	Wandlerbreite		Ø 40 mm 95 mm
ASK 63.4	Primärleiter		60 x 30 mm
	Rundleiter		50 x 40 mm
	Wandlerbreite		Ø 44 mm 96 mm
ASK 63.6	Primärleiter		60 x 30 mm
	Rundleiter		Ø 30 mm
	Wandlerbreite		88 mm
ASK 81.4 ASK 81.4 2U ASK 81.4 3U	Primärleiter		80 x 10 mm
	Rundleiter		60 x 30 mm
	Wandlerbreite		2 x 60 x 10 mm Ø 55 mm 120 mm
ASK 83.4	Primärleiter		84 x 34 mm
	Rundleiter		Ø 34 mm
	Wandlerbreite		96 mm



ASK 61.4

Aufsteck-Stromwandler



Schiene 1	63 x 10 mm
Schiene 2	2 x 50 x 10 mm
Rundleiter	44 mm
Baubreite	96 mm
Bauhöhe	105,5 mm
Bautiefe gesamt	58 mm

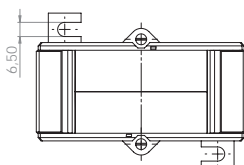
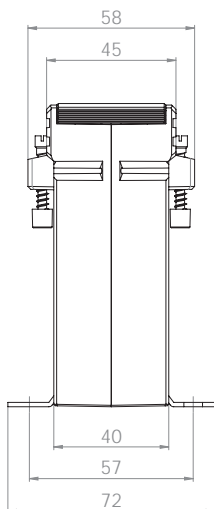
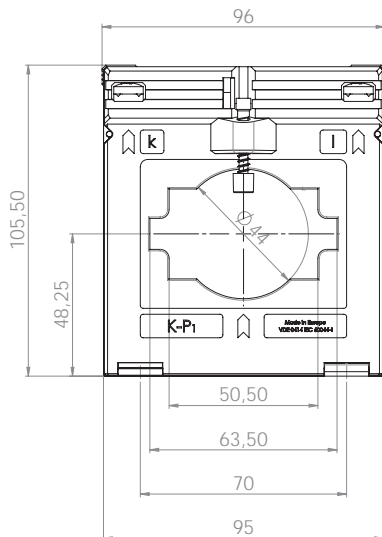

Primärstrom [A]	Bürde [VA]	Sekundärstrom [A] / Klasse				
		5 A Kl. 1 Best.-Nr.	5 A Kl. 0,5 Best.-Nr.	5 A Kl. 0,2s Best.-Nr.	1 A Kl. 1 Best.-Nr.	1 A Kl. 0,5 Best.-Nr.
200	1,5	19047	19009		19247	19209
	2,5	19048	19010		19248	19210
250	1,5	19049	19011	V41-1804C	19249	19211
	2,5	19050	19012	V41-1804D	19250	19212
	5	19111			19175	
300	1,5	19051	19013		19251	19213
	2,5	19052	19014	V41-1904D	19252	19214
	5	19053	19015	V41-1904F	19253	19215
400	1,5	19054	19016		19254	19216
	2,5	19055	19017	V41-2004D	19255	19217
	5	19056	19018	V41-2004F	19256	19218
	10	19057	19094	V41-2004H	19257	19294
500	1,5		19019			19219
	2,5	19058	19020	V41-2104D	19258	19220
	5	19059	19021	V41-2104F	19259	19221
	10	19060	19095	V41-2104H	19260	19295
	15	19061			19261	
600	2,5	19062	19022	V41-2204D	19262	19222
	5	19063	19023	V41-2204F	19263	19223
	10	19064	19024	V41-2204H	19264	19224
	15	19065	19097	V41-2204J	19265	19297
750	2,5	19066	19025	V41-2304D	19266	19225
	5	19067	19026	V41-2304F	19267	19226
	10	19068	19027	V41-2304H	19268	19227
	15	19069	19098	V41-2304J	19269	19298
800	2,5	19070	19028		19270	19228
	5	19071	19029		19271	19229
	10	19072	19030		19272	19230
	15	19073	19031		19273	19231
1000	2,5			V41-2504D		
	5	19074	19032	V41-2504F	19274	19232
	10	19075	19033	V41-2504H	19275	19233
	15	19076	19034	V41-2504J	19276	19234
1200	2,5			V41-2604D		
	5	19078	19035	V41-2604F	19278	19235
	10	19079	19036	V41-2604H	19279	19236
	15	19080	19037	V41-2604J	19280	19237
	30	19081	19100		19281	19300



Primärstrom [A]	Bürde [VA]	Sekundärstrom [A] / Klasse				
		5 A Kl. 1 Best.-Nr.	5 A Kl. 0,5 Best.-Nr.	5 A Kl. 0,2s Best.-Nr.	1 A Kl. 1 Best.-Nr.	1 A Kl. 0,5 Best.-Nr.
1250	5	19082	19038	V41-2704F	19282	19238
	10	19083	19039	V41-2704H	19283	19239
	15	19084	19040	V41-2704J	19284	19240
	30	19085	19101		19285	19301
1500	5	19086	19041	V41-2804F	19286	19241
	10	19087	19042	V41-2804H	19287	19242
	15	19088	19043	V41-2804J	19288	19243
	30	19089	19102		19289	19302
1600	5	19090	19044		19290	19244
	10	19091	19045		19291	19245
	15	19092	19046		19292	19246
	30	19093	19103		19293	19303

		Best.-Nr.
	Schnappbefestigung	-
	Plombierplatte Form C	59042

- Bitte beachten: Stromwandler in Kl.0,2s nur für Schiene 60x10 mm lieferbar



ASK 61.4 2U

Aufsteck-Stromwandler, sekundär umschaltbar



Schiene 1	63 x 10 mm
Schiene 2	2 x 50 x 10 mm
Rundleiter	44 mm
Baubreite	96 mm
Bauhöhe	105,5 mm
Bautiefe gesamt	58 mm

Primärstrom [A]	Bürde [VA]	Sekundärstrom [A] / Klasse	
		5 A Kl. 1 Best.-Nr.	1 A Kl. 1 Best.-Nr.
500-250	5-2,5	19141	19341
600-300	5-2,5	19142	19342
	10-5	19143	19343
800-400	5-2,5	19144	19344
	10-5	19145	19345
	15-7,5	19146	19346
1000-500	5-2,5	19147	19347
	10-5	19148	19348
	15-7,5	19149	19349
1200-600	5-2,5	19150	19350
	10-5	19151	19351
	15-7,5	19152	19352

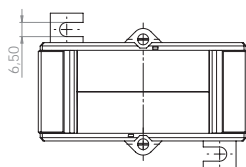
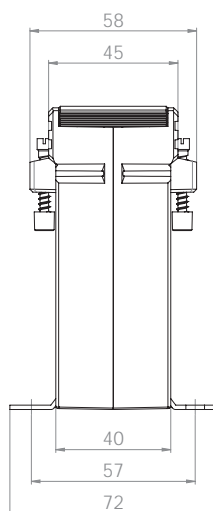
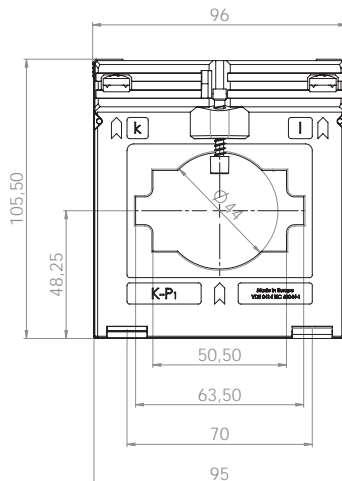

ASK 61.4 3U

Aufsteck-Stromwandler, sekundär umschaltbar

Primärstrom [A]	Bürde [VA]	Sekundärstrom [A] / Klasse	
		5 A Kl. 1 Best.-Nr.	1 A Kl. 1 Best.-Nr.
800-400-200	10-5-2,5	19182	19382
1000-500-250	10-5-2,5	19183	19383
	15-7,5-2,5	19184	19384
1000-600-300	10-5-2,5	19185	19385
	15-7,5-2,5	19186	19386
1000-600-400	10-5-2,5	19199	19399
1200-600-300	10-5-2,5	19187	19387
	15-7,5-2,5	19188	19388

		Best.-Nr.
	Schnappbefestigung	-
	Plombierplatte Form C	59042





ASK 61.6

Aufsteck-Stromwandler



Schiene 1	60 x 10 mm
Schiene 2	50 x 30 mm
Rundleiter	40 mm
Baubreite	95 mm
Bauhöhe	116 mm
Bautiefe gesamt	74 mm

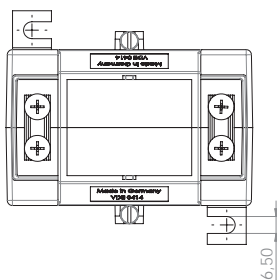
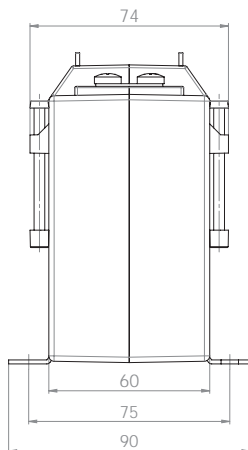
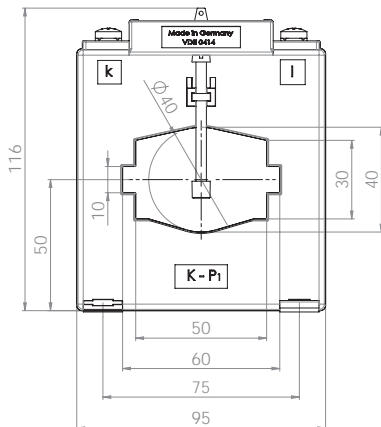

Primärstrom [A]	Bürde [VA]	Sekundärstrom [A] / Klasse			
		5 A Kl. 1 Best.-Nr.	5 A Kl. 0,5 Best.-Nr.	1 A Kl. 1 Best.-Nr.	1 A Kl. 0,5 Best.-Nr.
100	1,5	20063	20011	20263	20211
	2,5	20065	20012	20265	20212
150	1,5	20066	20013	20266	20213
	2,5	20067	20014	20267	20214
200	5	20068	20015	20268	20215
	10	20069		20269	
250	2,5	20116	20016	20321	20216
	5	20070	20017	20270	20217
300	10	20071		20271	
	15	20072		20272	
400	2,5	20117	20019	20322	20219
	5	20073	20020	20273	20220
500	10	20074	20021	20274	20221
	15	20075		20275	
600	2,5	20118	20023	20323	20223
	5	20076	20024	20276	20224
750	10	20077	20025	20277	20225
	15	20078	20026	20278	20226
900	30	20079		20279	
	2,5	20119	20027	20324	20227
1050	5	20080	20028	20280	20228
	10	20081	20029	20281	20229
1200	15	20082	20030	20282	20230
	30	20083		20283	
1350	2,5	20120	20031	20325	20231
	5	20084	20032	20284	20232
1500	10	20085	20033	20285	20233
	15	20086	20034	20286	20234
1800	30	20087		20287	
	2,5	20121	20035	20326	20235
2100	5	20088	20036	20288	20236
	10	20089	20037	20289	20237
2400	15	20090	20038	20290	20238
	30	20091		20291	
2700	5	20092	20040	20292	20240
	10	20093	20041	20293	20241
3000	15	20094	20042	20294	20242
	30	20095		20295	
3300	5	20122	20043	20327	20243
	10	20096	20044	20296	20244
3600	15	20097	20045	20297	20245
	30	20098	20046	20298	20246
3900	45	20099		20299	
	5	20123	20047	20328	20247
4200	10	20100	20048	20300	20248
	15	20101	20049	20301	20249
4500	30	20102	20050	20302	20250
	45	20103		20303	



Primärstrom [A]	Bürde [VA]	Sekundärstrom [A] / Klasse			
		5 A Kl. 1 Best.-Nr.	5 A Kl. 0,5 Best.-Nr.	1 A Kl. 1 Best.-Nr.	1 A Kl. 0,5 Best.-Nr.
1250	5	20124	20051	20329	20251
	10	20104	20052	20304	20252
	15	20105	20053	20305	20253
	30	20106	20054	20306	20254
	45	20107		20307	
1500	5	20125	20055	20330	20255
	10	20108	20056	20308	20256
	15	20109	20057	20309	20257
	30	20110	20058	20310	20258
	45	20111		20311	

		Best.-Nr.
	Schnappbefestigung	-
	Plombierplatte Form E	59044



ASK 63.4

Aufsteck-Stromwandler



- Schiene 1 60 x 30 mm
- Schiene 2 50 x 40 mm
- Rundleiter 44 mm
- Baubreite 96 mm
- Bauhöhe 105,5 mm
- Bautiefe gesamt 58 mm

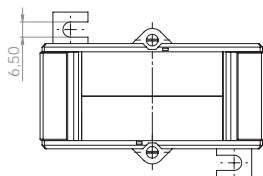
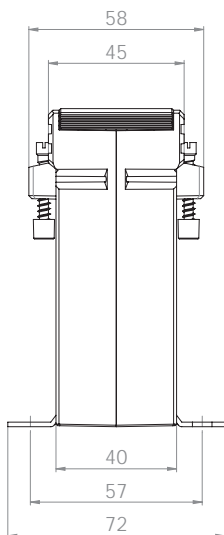
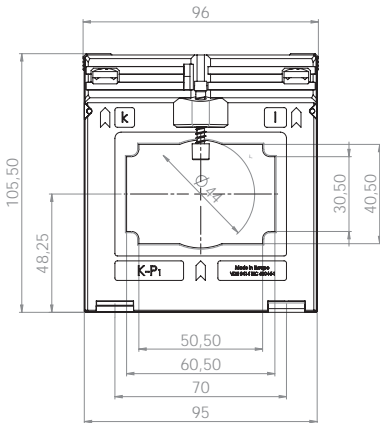

Primärstrom [A]	Bürde [VA]	Sekundärstrom [A] / Klasse			
		5 A Kl. 1 Best.-Nr.	5 A Kl. 0,5 Best.-Nr.	1 A Kl. 1 Best.-Nr.	1 A Kl. 0,5 Best.-Nr.
300	1,5	25041	25011	25241	25211
	2,5	25042	25012	25242	25212
400	2,5	25043	25013	25243	25213
	5	25044	25014	25244	25214
500	5	25045	25015	25245	25215
	10	25046		25246	
600	5	25047	25017	25247	25217
	10	25048	25018	25248	25218
	15	25049		25249	
750	5	25050	25020	25250	25220
	10	25051	25021	25251	25221
	15	25052	25022	25252	25222
800	5	25053	25023	25253	25223
	10	25054	25024	25254	25224
	15	25055	25025	25255	25225
1000	5	25056	25026	25256	25226
	10	25057	25027	25257	25227
	15	25058	25028	25258	25228
1200	5	25059	25029	25259	25229
	10	25060	25030	25260	25230
	15	25061	25031	25261	25231
1250	5	25062	25032	25262	25232
	10	25063	25033	25263	25233
	15	25064	25034	25264	25234
1500	5	25065	25035	25265	25235
	10	25066	25036	25266	25236
	15	25067	25037	25267	25237
1600	5	25068VG	25038VG		
	10	25069VG	25039VG		
	15	25070VG	25040VG		

		Best.-Nr.
	Schnappbefestigung	–
	Plombierplatte Form C	59042



ASK 63.6

Aufsteck-Stromwandler



- Schiene 1 60 x 30 mm
- Rundleiter 30 mm
- Baubreite 88 mm
- Bauhöhe 129 mm
- Bautiefe gesamt 78 mm

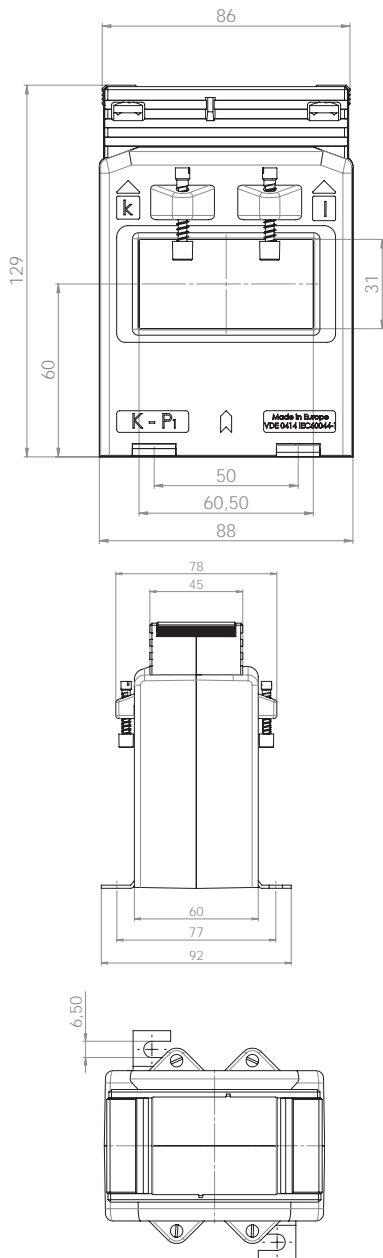

Primärstrom [A]	Bürde [VA]	Sekundärstrom [A] / Klasse			
		5 A Kl. 1 Best.-Nr.	5 A Kl. 0,5 Best.-Nr.	1 A Kl. 1 Best.-Nr.	1 A Kl. 0,5 Best.-Nr.
200	1,5	85060		85260	
	2,5	85061		85261	
250	1,5	85062	85011	85262	85211
	2,5	85063	85012	85263	85212
	5	85116		85316	
300	1,5	85064	85013	85264	85213
	2,5	85065	85014	85265	85214
	5	85066	85015	85266	85215
	10	85067		85267	
400	2,5	85068	85017	85268	85217
	5	85069	85018	85269	85218
	10	85071			
500	2,5	85073	85021	85273	85221
	5	85074	85022	85274	85222
	10	85075		85275	
	15	85076		85276	
600	2,5	85077	85025	85277	85225
	5	85078	85026	85278	85226
	10	85079	85027	85279	85227
	15	85080		85280	
750	2,5	85081	85029	85281	85229
	5	85082	85030	85282	85230
	10	85083	85031	85283	85231
	15	85084		85284	
800	2,5	85085	85033	85285	85233
	5	85086	85034	85286	85234
	10	85087	85035	85287	85235
	15	85088	85036	85288	85236
1000	5	85089	85037	85289	85237
	10	85090	85038	85290	85238
	15	85091	85039	85291	85239
	30	85092		85292	
1200	5	85093	85041	85293	85241
	10	85094	85042	85294	85242
	15	85095	85043	85295	85243
	30	85096		85296	
1250	5	85097	85045	85297	85245
	10	85098	85046	85298	85246
	15	85099	85047	85299	85247
	30	85100		85300	
1500	5	85101	85049	85301	85249
	10	85102	85050	85302	85250
	15	85103	85051	85303	85251
	30	85104		85304	
1600	5	85105	85053	85305	85253
	10	85106	85054	85306	85254
	15	85107	85055	85307	85255
	30	85108		85308	
2000	5	85109VV	85056VV	85309VV	85256VV
	10	85110VV	85057VV	85310VV	85257VV
	15	85111VV	85058VV	85311VV	85258VV

		Best.-Nr.
	Schnappbefestigung	-
	Plombierplatte Form C	59042

ASR
ASG
ASK
WSK
KBR / KBU
KSU / SUSK
NH
SASR / SASK
ASRD
ASKD / WSKD
CTB



ASK 81.4

Aufsteck-Stromwandler



Schiene 1	80 x 10 mm
Schiene 2	60 x 30 mm
Schiene 3	2 x 60 x 10 mm
Rundleiter	55 mm
Baubreite	120 mm
Bauhöhe	123,5 mm
Bautiefe gesamt	58 mm

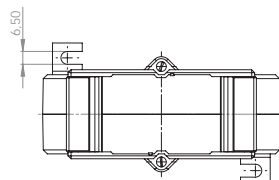
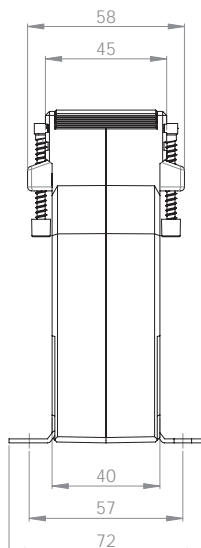
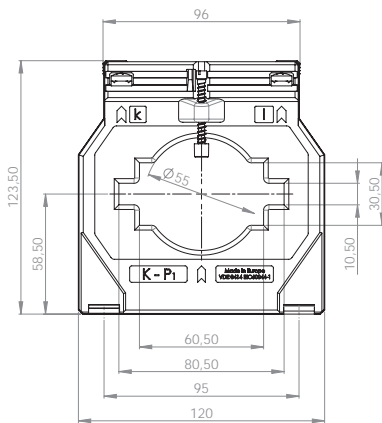

Primärstrom [A]	Bürde [VA]	Sekundärstrom [A] / Klasse				
		5 A Kl. 1 Best.-Nr.	5 A Kl. 0,5 Best.-Nr.	5 A Kl. 0,2s Best.-Nr.	1 A Kl. 1 Best.-Nr.	1 A Kl. 0,5 Best.-Nr.
400	2,5	21038	21009	V47-2004D	21238	21209
	5	21039	21010	V47-2004F	21239	21210
	10	21198			21292	
500	2,5	21040	21011	V47-2104D	21240	21211
	5	21041	21135	V47-2104F	21241	21335
	10	21042	21078		21242	21278
600	2,5	21043	21012	V47-2204D	21243	21212
	5	21044	21013	V47-2204F	21244	21213
	10	21045	21014	V47-2204H	21245	21214
750	2,5	21046	21015	V47-2304D	21246	21215
	5	21047	21016	V47-2304F	21247	21216
	10	21048	21017	V47-2304H	21248	21217
	15	21049	21079		21249	21279
800	2,5	21050	21018		21250	21218
	5	21051	21019		21251	21219
	10	21052	21020		21252	21220
	15	21053	21080		21253	21280
1000	2,5	21084				
	5	21054	21021	V47-2504F	21254	21221
	10	21055	21022	V47-2504H	21255	21222
	15	21056	21023	V47-2504J	21256	21223
1200	30	21057			21257	
	5	21058	21024	V47-2604F	21258	21224
	10	21059	21025	V47-2604H	21259	21225
	15	21060	21026	V47-2604J	21260	21226
1250	5	21062	21027	V47-2704F	21262	21227
	10	21063	21028	V47-2704H	21263	21228
	15	21064	21029	V47-2704J	21264	21229
1500	5	21085	21030	V47-2804F	21285	21230
	10	21066	21031	V47-2804H	21266	21231
	15	21067	21032	V47-2804J	21267	21232
	30	21068			21268	
1600	5	21086	21033		21286	21233
	10	21070	21034		21270	21234
	15	21071	21035		21271	21235
	30	21072			21272	
2000	10	21074	21036		21274	21236
	15	21075	21037		21275	21237
	30	21076			21276	

		Best.-Nr.
	Schnappbefestigung	-
	Plombierplatte Form C	59042



Schiene 1	80 x 10 mm
Schiene 2	60 x 30 mm
Schiene 3	2 x 60 x 10 mm
Rundleiter	55 mm
Baubreite	120 mm
Bauhöhe	123,5 mm
Bautiefe gesamt	58 mm

ASK 81.4 2U

Aufsteck-Stromwandler, sekundär umschaltbar

Primärstrom [A]	Bürde [VA]	Sekundärstrom [A] / Klasse	
		5 A Kl. 1 Best.-Nr.	1 A Kl. 1 Best.-Nr.
1000-500	10-5	21120	21320
	15-7,5	21121	21321
1200-600	10-5	21122	21322
	15-7,5	21123	21323
1500-750	10-5	21124	21324
	15-7,5	21125	21325
	30-15	21126	21326
1600-800	10-5	21127	21327
	15-7,5	21128	21328

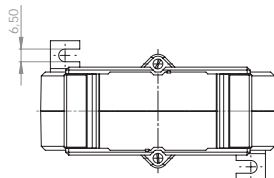
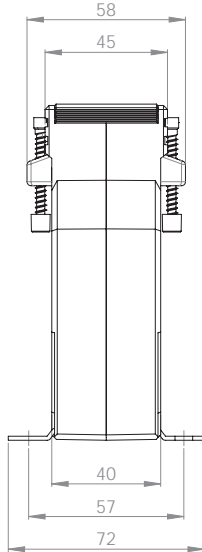
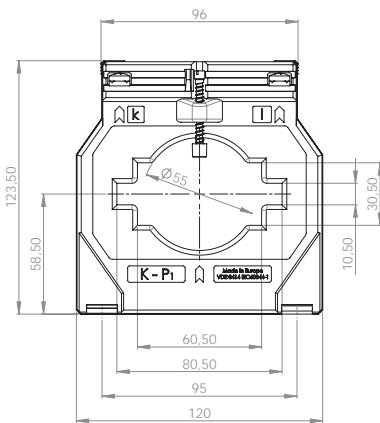

ASK 81.4 3U

Aufsteck-Stromwandler, sekundär umschaltbar

Primärstrom [A]	Bürde [VA]	Sekundärstrom [A] / Klasse	
		5 A Kl. 1 Best.-Nr.	1 A Kl. 1 Best.-Nr.
1000-750-500	10-5-2,5	21166	21366
1200-800-600	15-10-5	21164	21364
1500-1000-500	15-10-5	21163	21363
1500-1000-750	15-10-5	21165	21365
1600-800-400	15-10-5	21162	21362

		Best.-Nr.
	Schnappbefestigung	-
	Plombierplatte Form C	59042



ASK 83.4

Aufsteck-Stromwandler



Wahlweise wählbare Sekundärklemmenpositionen ermöglichen flexible Einbaulagen.

Schiene 1	84 x 34 mm
Rundleiter	34 mm
Baubreite	96 mm
Bauhöhe	117 mm
Bautiefe gesamt	68 mm

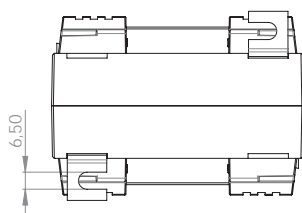
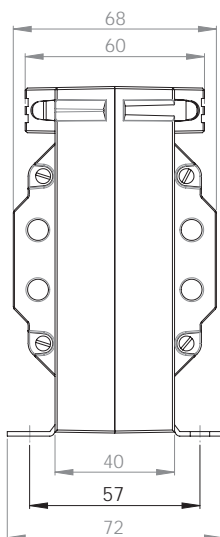
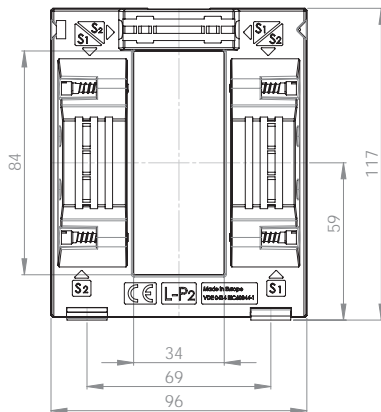

Primärstrom [A]	Bürde [VA]	Sekundärstrom [A] / Klasse			
		5 A Kl. 1 Best.-Nr.	5 A Kl. 0,5 Best.-Nr.	1 A Kl. 1 Best.-Nr.	1 A Kl. 0,5 Best.-Nr.
300	1,5	100051-x	100011-x	100251-x	100211-x
	2,5	100052-x	100012-x	100252-x	100212-x
400	2,5	100053-x	100013-x	100253-x	100213-x
	5	100054-x	100014-x	100254-x	100214-x
500	2,5	100055-x	100015-x	100255-x	100215-x
	5	100056-x	100016-x	100256-x	100216-x
600	2,5	100057-x	100017-x	100257-x	100217-x
	5	100058-x	100018-x	100258-x	100218-x
750	10	100059-x		100259-x	
	2,5	100060-x	100019-x	100260-x	100219-x
	5	100061-x	100020-x	100261-x	100220-x
800	10	100062-x	100021-x	100262-x	100221-x
	15	100063-x		100263-x	
	2,5	100064-x	100022-x	100264-x	100222-x
1000	5	100065-x	100023-x	100265-x	100223-x
	10	100066-x	100024-x	100266-x	100224-x
	15	100067-x		100267-x	
1200	5	100068-x	100025-x	100268-x	100225-x
	10	100069-x	100026-x	100269-x	100226-x
	15	100070-x	100027-x	100270-x	100227-x
1250	5	100071-x	100028-x	100271-x	100228-x
	10	100072-x	100029-x	100272-x	100229-x
	15	100073-x	100030-x	100273-x	100230-x
1500	5	100074-x	100031-x	100274-x	100231-x
	10	100075-x	100032-x	100275-x	100232-x
	15	100076-x	100033-x	100276-x	100233-x
1600	5	100077-x	100034-x	100277-x	100234-x
	10	100078-x	100035-x	100278-x	100235-x
	15	100079-x	100036-x	100279-x	100236-x
1800	5	100080-x	100037-x	100280-x	100237-x
	10	100081-x	100038-x	100281-x	100238-x
	15	100082-x	100039-x	100282-x	100239-x
2000	30	100083-x		100283-x	
	10	100084-x	100040-x	100284-x	100240-x
	15	100085-x	100041-x	100285-x	100241-x
2000	30	100086-x		100286-x	
	10	100087-x	100042-x	100287-x	100242-x
	15	100088-x	100043-x	100288-x	100243-x
	30	100089-x		100289-x	

		Best.-Nr.
	Schnappbefestigung	-
	Plombierplatte	-



ASK 83.4

Aufsteck-Stromwandler

Die Sekundärausleitungen des Stromwandlertyps ASK 83.4 können optional in 6 verschiedenen Positionen ausgeführt werden. Bitte gewünschte Anschlussbelegung bei der Bestellung mit angeben.

Anschlussbelegung

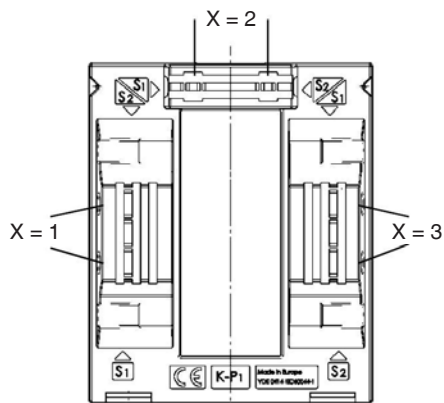

Anschlussbelegung

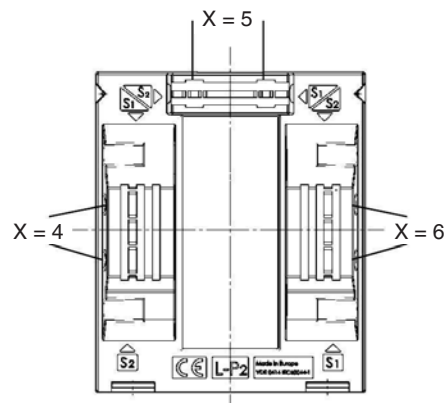



Bestellbeispiel

ASK 83.4 800/5A 10VA KI.1
Anschlussbelegung K-P₁ (G.U.) oben
Best.-Nr. 100066-2



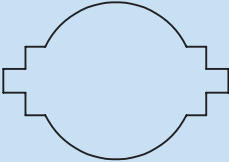
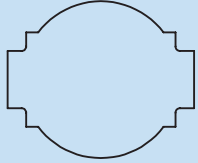

Aufsteck-Stromwandler

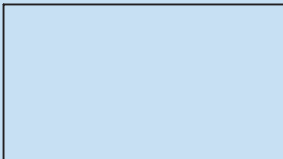
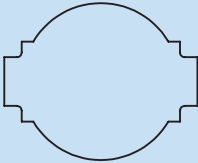
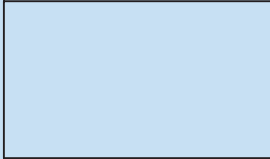
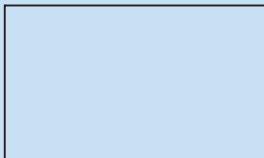
ASK 101.4 ASK 101.4 2U	Primärleiter		100 x 10 mm
	Rundleiter Wandlerbreite		2 x 80 x 10 mm Ø 70 mm 130 mm
ASK 103.3	Primärleiter		2 x 100 x 10 mm
	Rundleiter Wandlerbreite		3 x 80 x 10 mm Ø 85 mm 172 mm
ASK 103.41 ASK 103.41 2U	Primärleiter		103 x 41 mm
	Rundleiter Wandlerbreite		Ø 40 mm 99 mm
ASK 105.6	Primärleiter		100 x 55 mm
	Rundleiter Wandlerbreite		Ø 55 mm 129 mm
ASK 105.6N	Primärleiter		100 x 55 mm
	Rundleiter Wandlerbreite		Ø 55 mm 129 mm
ASK 123.3	Primärleiter		123 x 30 mm
	Rundleiter Wandlerbreite		3 x 100 x 10 mm Ø 100 mm 172 mm
ASK 127.4	Primärleiter		120 x 70 mm
	Rundleiter Wandlerbreite		Ø 70 mm 159 mm
ASK 127.6	Primärleiter		120 x 72 mm
	Rundleiter Wandlerbreite		Ø 72 mm 205 mm



ASK 101.4

Aufsteck-Stromwandler



Schiene 1	100 x 10 mm
Schiene 2	2 x 80 x 10 mm
Rundleiter	70 mm
Baubreite	130 mm
Bauhöhe	141 mm
Bautiefe gesamt	58 mm

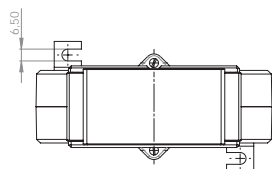
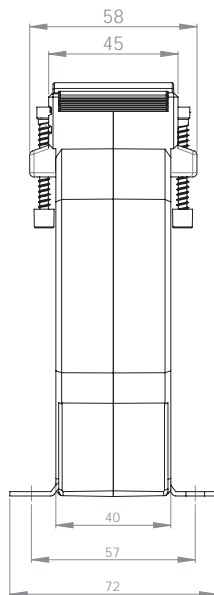
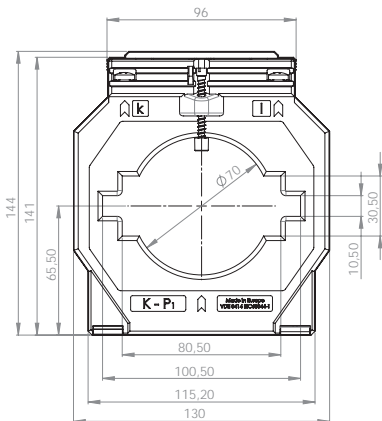

Primärstrom [A]	Bürde [VA]	Sekundärstrom [A] / Klasse			
		5 A Kl. 1 Best.-Nr.	5 A Kl. 0,5 Best.-Nr.	1 A Kl. 1 Best.-Nr.	1 A Kl. 0,5 Best.-Nr.
500	2,5		22009		22209
	5	22076	22010	22276	22210
	10	22077		22277	
600	2,5		22011		22211
	5	22038	22012	22238	22212
	10	22039		22239	
750	2,5		22013		22213
	5	22040	22014	22240	22214
	10	22041	22078	22241	22281
800	5	22042	22015	22242	22215
	10	22043	22016	22243	22216
	15	22044		22244	
1000	5	22045	22017	22245	22217
	10	22046	22018	22246	22218
	15	22047		22247	
1200	5	22048	22019	22248	22219
	10	22049	22020	22249	22220
	15	22050		22250	
	30	22051		22251	
1250	5	22052	22021	22252	22221
	10	22053	22022	22253	22222
	15	22054		22254	
	30	22055		22255	
1500	5	22056	22023	22256	22223
	10	22057	22024	22257	22224
	15	22058	22025	22258	22279
	30	22059		22259	
1600	5		22026		22226
	10	22060	22027	22260	22227
	15	22061	22028	22261	22228
	30	22062		22262	
1800	5		22029		22229
	10	22064	22030	22264	22230
	15	22065	22031	22265	22231
	30	22066		22266	
2000	5		22032		22232
	10	22068	22033	22268	22233
	15	22069	22034	22269	22234
	30	22070	22118	22270	22280

		Best.-Nr.
	Schnappbefestigung	-
	Plombierplatte Form C	59042



ASK 101.4 2U

Aufsteck-Stromwandler, sekundär umschaltbar



- Schiene 1 100 x 10 mm
- Schiene 2 2 x 80 x 10 mm
- Rundleiter 70 mm
- Baubreite 130 mm
- Bauhöhe 141 mm
- Bautiefe gesamt 58 mm

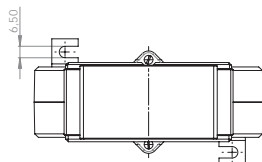
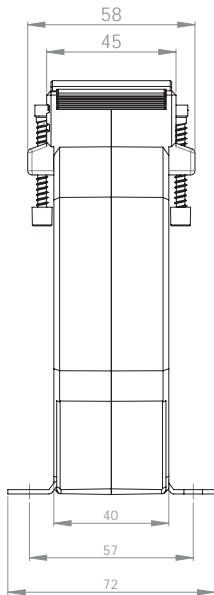
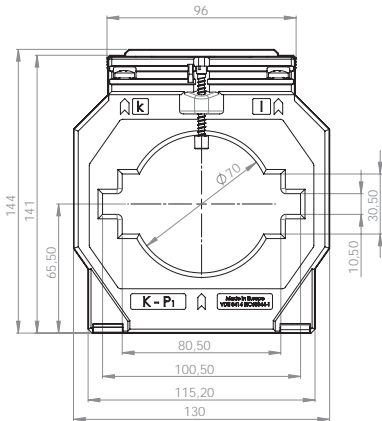

Primärstrom [A]	Bürde [VA]	Sekundärstrom [A] / Klasse	
		5 A Kl. 1 Best.-Nr.	1 A Kl. 1 Best.-Nr.
1200-600	10-5	22120	22320
	15-7,5	22121	22321
1500-750	10-5	22122	22322
	15-7,5	22123	22323
1600-800	10-5	22124	22324
	15-7,5	22125	22325
	30-15	22126	22326
2000-1000	10-5	22127	22327
	15-7,5	22128	22328
	30-15	22129	22329

		Best.-Nr.
	Schnappbefestigung	-
	Plombierplatte Form C	59042

ASR

ASG

ASK

WSK

KBR / KBU

KSU / SUJK

NH

SASR / SASK

ASRD

ASKD / WSKD

CTB



ASK 103.3



Aufsteck-Stromwandler

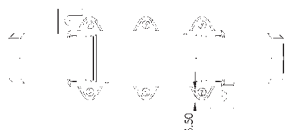
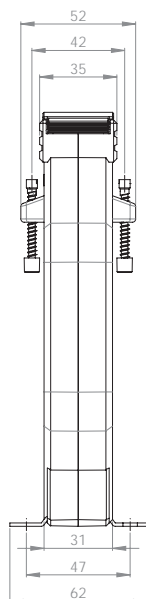
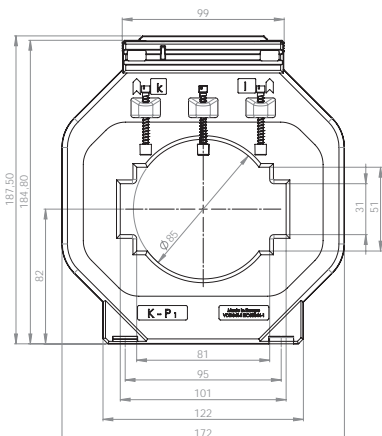

- Schiene 1 2 x 100 x 10 mm
- Schiene 2 3 x 80 x 10 mm
- Rundleiter 85 mm
- Baubreite 172 mm
- Bauhöhe 184,8 mm
- Bautiefe gesamt 52 mm



Primärstrom [A]	Bürde [VA]	Sekundärstrom [A] / Klasse			
		5 A Kl. 1 Best.-Nr.	5 A Kl. 0,5 Best.-Nr.	1 A Kl. 1 Best.-Nr.	1 A Kl. 0,5 Best.-Nr.
750	2,5		23011		23211
	5	23036	23076	23236	23276
	10	23037		23237	
800	2,5		23012		23212
	5	23038	23013	23238	23213
	10	23039	23077	23239	23277
	15	23040		23240	
1000	5	23041	23014	23241	23214
	10	23042	23015	23242	23215
	15	23043	23016	23243	23216
1200	5	23044	23017	23244	23217
	10	23045	23018	23245	23218
	15	23046	23019	23246	23219
	30	23047		23247	
1250	5	23048	23020	23248	23220
	10	23049	23021	23249	23221
	15	23050	23022	23250	23222
	30	23051		23251	
1500	10	23052	23023	23252	23223
	15	23053	23024	23253	23224
	30	23054		23254	
1600	10	23056	23025	23256	23225
	15	23057	23026	23257	23226
	30	23058		23258	
2000	10	23060	23027	23260	23227
	15	23061	23028	23261	23228
	30	23062	23029	23262	23229
2500	10	23064	23030	23264	23230
	15	23065	23031	23265	23231
	30	23066	23032	23266	23232
3000	10	23068	23033	23268	23233
	15	23069	23034	23269	23234
	30	23070	23035	23270	23235

		Best.-Nr.
	Schnappbefestigung	-
	Plombierplatte Form A	59040



ASK 103.41

Aufsteck-Stromwandler



Schiene 1	103 x 41 mm
Rundleiter	40 mm
Baubreite	99 mm
Bauhöhe	150 mm
Bautiefe gesamt	58 mm

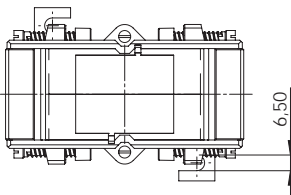
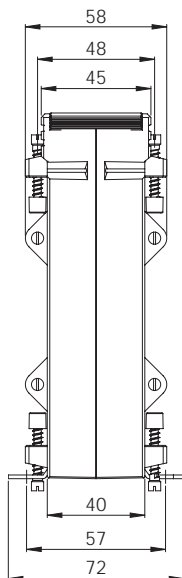
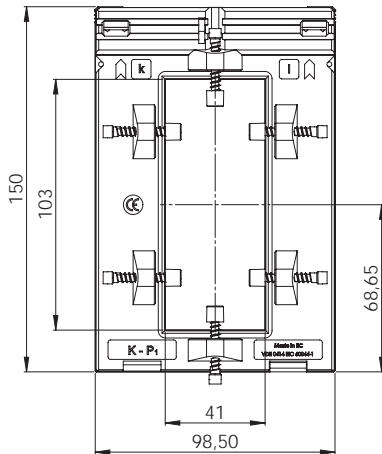

Primärstrom [A]	Bürde [VA]	Sekundärstrom [A] / Klasse			
		5 A Kl. 1 Best.-Nr.	5 A Kl. 0,5 Best.-Nr.	1 A Kl. 1 Best.-Nr.	1 A Kl. 0,5 Best.-Nr.
400	2,5	97051	97021	97251	97221
	5	97052		97252	
500	2,5	97053	97023	97253	97223
	5	97054		97254	
600	2,5	97055	97025	97255	97225
	5	97056		97256	
750	2,5	97057	97027	97257	97227
	5	97058		97258	
800	5	97059	97029	97259	97229
	10	97060		97260	
1000	10	97061	97031	97261	97231
	15	97062		97262	
1200	10	97063	97033	97263	97233
	15	97064		97264	
1250	10	97065	97035	97265	97235
	15	97066		97266	
1500	15	97067	97037	97267	97237
	30	97068		97268	
2000	15	97069	97039	97269	97239
	30	97070		97270	

ASK 103.41 2U

Aufsteck-Stromwandler, sekundär umschaltbar

Primärstrom [A]	Bürde [VA]	Sekundärstrom [A] / Klasse			
		5 A Kl. 1 Best.-Nr.	5 A Kl. 0,5 Best.-Nr.	1 A Kl. 1 Best.-Nr.	1 A Kl. 0,5 Best.-Nr.
1000-500	5-2,5	97081	97071	97281	97271
1200-600	5-2,5	97082	97072	97282	97272
1500-750	10-5	97083	97073	97283	97273
	15-7,5	97084		97284	
2000-1000	15-7,5	97085	97075	97285	97275
	30-15	97086		97286	

		Best.-Nr.
	Schnappbefestigung	-
	Plombierplatte	-



ASK 105.6

Aufsteck-Stromwandler



Schiene 1	100 x 55 mm
Rundleiter	55 mm
Baubreite	129 mm
Bauhöhe	167 mm
Bautiefe gesamt	78 mm

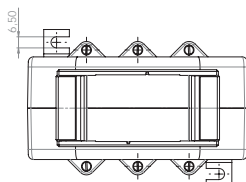
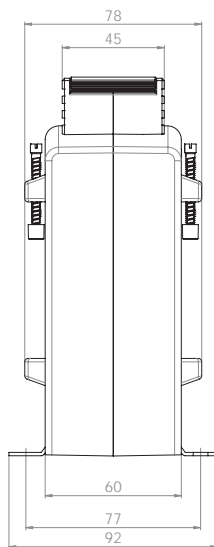
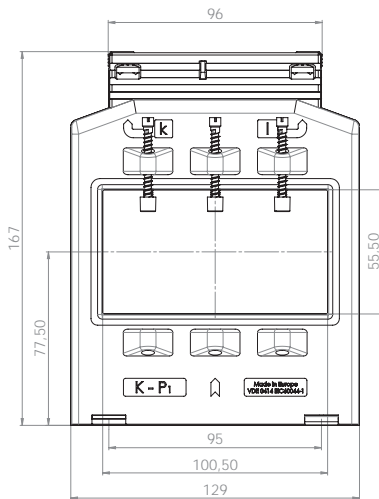

Primärstrom [A]	Bürde [VA]	Sekundärstrom [A] / Klasse				
		5 A Kl. 1 Best.-Nr.	5 A Kl. 0,5 Best.-Nr.	5 A Kl. 0,2s Best.-Nr.	1 A Kl. 1 Best.-Nr.	1 A Kl. 0,5 Best.-Nr.
600	2,5		86083	V55-2204D		86283
	5	86092	86084		86292	86284
	10	86093			86293	
750	2,5		86086	V55-2304D		86286
	5	86095	86087	V55-2304F	86295	86287
	10	86096	86157		86296	86357
800	5	86097	86089	V55-2404F	86297	86289
	10	86098	86090		86298	86290
	2,5		86158			
1000	5	86051	86011	V55-2504F	86251	86211
	10	86052	86159	V55-2504H	86252	86359
	15	86113	86160		86299	86360
1200	5	86053	86013	V55-2604F	86253	86213
	10	86054	86014	V55-2604H	86254	86214
	15	86055	86015		86255	86215
1250	5	86056	86016	V55-2704F	86256	86216
	10	86057	86017	V55-2704H	86257	86217
	15	86058	86018	V55-2704J	86258	86218
1500	5	86059	86019	V55-2804F	86259	86219
	10	86060	86020	V55-2804H	86260	86220
	15	86061	86021	V55-2804J	86261	86221
	30	86062	86163		86262	86363
1600	5	86110	86164	V55-2904F		
	10	86142	86165	V55-2904H	86331	86338
	15	86101	86149	V55-2904J	86330	86339
	30	86138	86166		86337	86340
1800	5	86063	86023		86263	86223
	10	86064	86024		86264	86224
	15	86065	86025		86265	86225
	30	86066			86266	
2000	5		86167	V55-3004F		
	10	86067	86027	V55-3004H	86267	86227
	15	86068	86028	V55-3004J	86268	86228
	30	86069	86029		86269	86229
	45	86070			86270	
2400	10		86169	V55-3104H		
	15		86170	V55-3104J		
	30		86171			
2500	5		86172	V55-3204F		
	10	86071	86031	V55-3204H	86271	86231
	15	86072	86032	V55-3204J	86272	86232
	30	86073	86033		86273	86233
	45	86074			86274	
3000	5		86173	V55-3304F		
	10	86075	86035	V55-3304H	86275	86235
	15	86076	86036	V55-3304J	86276	86236
	30	86077	86037		86277	86237
	45	86078			86278	

		Best.-Nr.
	Schnappbefestigung	-
	Plombierplatte Form C	59042



ASK 105.6N

Aufsteck-Stromwandler



Schiene 1 100 x 55 mm
 Rundleiter 55 mm
 Baubreite 129 mm
 Bauhöhe 214 mm
 Bautiefe gesamt 78 mm

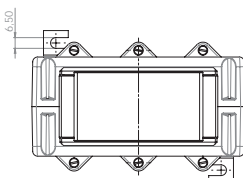
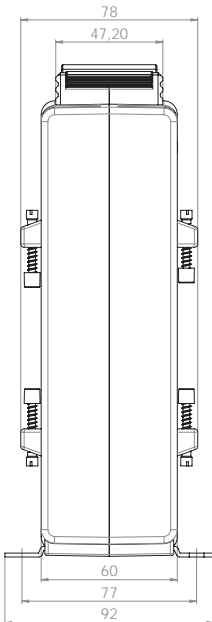
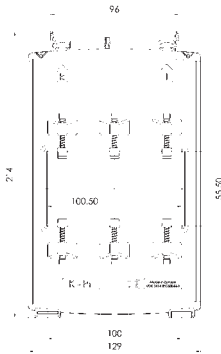

Primärstrom [A]	Bürde [VA]	Sekundärstrom [A] / Klasse			
		5 A Kl. 1 Best.-Nr.	5 A Kl. 0,5 Best.-Nr.	1 A Kl. 1 Best.-Nr.	1 A Kl. 0,5 Best.-Nr.
2500	10	86451	86481	86411	86431
	15	86452	86482	86412	86432
	30	86453	86483	86413	86433
	45	86454		86414	
3000	10	86455	86484	86415	86434
	15	86456	86485	86416	86435
	30	86457	86486	86417	86436
	45	86458		86418	
4000	10	86459	86487	86419	86437
	15	86460	86488	86420	86438
	30	86461	86489	86421	86439
	45	86462		86422	

		Best.-Nr.
	Schnappbefestigung	-
	Plombierplatte Form C	59042

ASR

ASG

ASK

WSK

KBR / KBU

KSU / SJSK

NH

SASR / SASK

ASRD

ASKD / WSKD

CTB



ASK 123.3

Aufsteck-Stromwandler



- Schiene 1 123 x 30 mm
- Schiene 2 3 x 100 x 10 mm
- Rundleiter 100 mm
- Baubreite 172 mm
- Bauhöhe 184,8 mm
- Bautiefe gesamt 52 mm

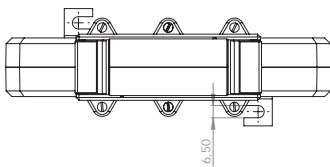
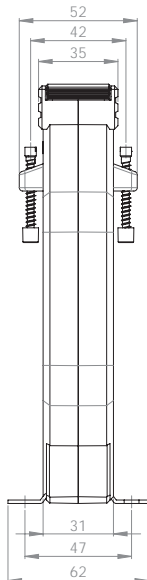
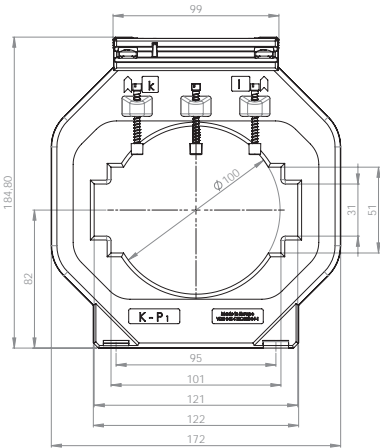

Primärstrom [A]	Bürde [VA]	Sekundärstrom [A] / Klasse				
		5 A Kl. 1 Best.-Nr.	5 A Kl. 0,5 Best.-Nr.	5 A Kl. 0,2s Best.-Nr.	1 A Kl. 1 Best.-Nr.	1 A Kl. 0,5 Best.-Nr.
750	2,5		24127			
	5		24128			
	10		24129			
1000	2,5		24010	V56-2504D		
	5	24037	24011	V56-2504F	24237	24211
	10	24038	24126		24238	24125
1200	5	24039	24012	V56-2604F	24239	24212
	10	24040	24013		24240	24213
	15	24041	24014		24241	24214
1250	5	24042	24015	V56-2704F	24242	24215
	10	24043	24016	V56-2704H	24243	24216
	15	24044	24017		24244	24217
1500	5	24045	24018	V56-2804F	24245	24218
	10	24046	24019	V56-2804H	24246	24219
	15	24047	24020		24247	24220
	30	24048			24248	
1600	5	24112		V56-2904F		
	10	24107		V56-2904H		
	15	24113		V56-2904J		
	30	24108	24131			
1800	5	24049	24021		24249	24221
	10	24050	24022		24250	24222
	15	24051	24023		24251	24223
	30	24052			24252	
2000	5		24024	V56-3004F		24224
	10	24053	24025	V56-3004H	24253	24225
	15	24054	24026	V56-3004J	24254	24226
	30	24055	24027		24255	24227
2500	5		24136	V56-3204F		
	10	24057	24028	V56-3204H	24257	24228
	15	24058	24029	V56-3204J	24258	24229
	30	24059	24030		24259	24230
3000	5		24137	V56-3304F		
	10	24061	24031	V56-3304H	24261	24231
	15	24062	24032	V56-3304J	24262	24232
	30	24063	24033		24263	24233
	45	24064			24264	

		Best.-Nr.
	Schnappbefestigung	–
	Plombierplatte Form A	59040



ASK 127.4

Aufsteck-Stromwandler



- Schiene 1 120 x 70 mm
- Rundleiter 70 mm
- Baubreite 159 mm
- Bauhöhe 195,3 mm
- Bautiefe gesamt 58 mm

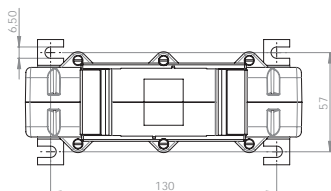
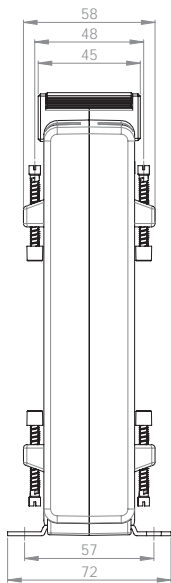
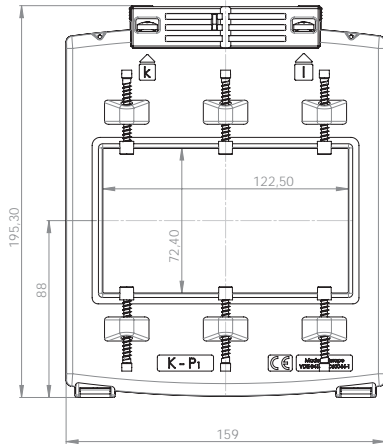

Primärstrom [A]	Bürde [VA]	Sekundärstrom [A] / Klasse			
		5 A Kl. 1 Best.-Nr.	5 A Kl. 0,5 Best.-Nr.	1 A Kl. 1 Best.-Nr.	1 A Kl. 0,5 Best.-Nr.
1000	5	87540	87510	87640	87610
	10	87541	87511	87641	87611
1200	5	87542	87512	87642	87612
	10	87543	87513	87643	87613
	15	87544	87514	87644	87614
1250	10	87545	87515	87645	87615
	15	87546	87516	87646	87616
	30	87547	87517	87647	87617
1500	10	87548	87518	87648	87618
	15	87549	87519	87649	87619
	30	87550	87520	87650	87620
1600	10	87551	87521	87651	87621
	15	87552	87522	87652	87622
	30	87553	87523	87653	87623
1800	10	87554	87524	87654	87624
	15	87555	87525	87655	87625
	30	87556	87526	87656	87626
2000	10	87557	87527	87657	87627
	15	87558	87528	87658	87628
	30	87559	87529	87659	87629
2500	10	87561	87531	87661	87631
	15	87562	87532	87662	87632
	30	87563	87533	87663	87633

		Best.-Nr.
	Schnappbefestigung	-
	Plombierplatte Form C	59042

ASR

ASG

ASK

WSK

KBR / KBU

KSU / SJSK

NH

SASR / SASK

ASRD

ASKD / WSKD

CTB



ASK 127.6

Aufsteck-Stromwandler

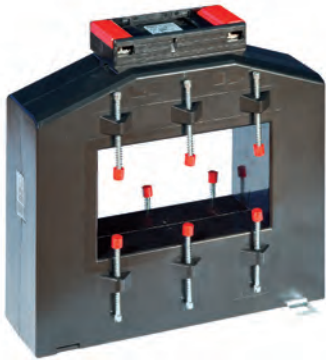

- Schiene 1 120 x 70 mm
- Rundleiter 70 mm
- Baubreite 205 mm
- Bauhöhe 203 mm
- Bautiefe gesamt 78 mm

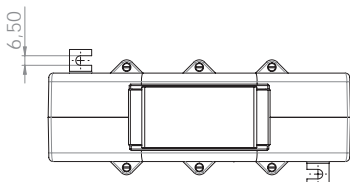
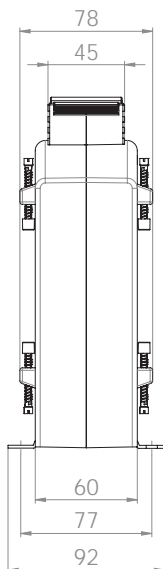
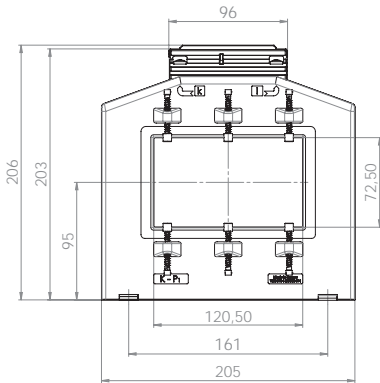



Primärstrom [A]	Bürde [VA]	Sekundärstrom [A] / Klasse			
		5 A Kl. 1 Best.-Nr.	5 A Kl. 0,5 Best.-Nr.	1 A Kl. 1 Best.-Nr.	1 A Kl. 0,5 Best.-Nr.
1000	5	87055	87011	87255	87211
	10	87056		87256	
1200	5	87057	87013	87257	87213
	10	87058	87014	87258	87214
	15	87059		87259	
1250	5	87060	87016	87260	87216
	10	87061	87017	87261	87217
	15	87062	87018	87262	87218
	30	87063	87019	87263	87219
1500	5	87064	87020	87264	87220
	10	87065	87021	87265	87221
	15	87066	87022	87266	87222
	30	87067	87023	87267	87223
1800	5	87068	87024	87268	87224
	10	87069	87025	87269	87225
	15	87070	87026	87270	87226
	30	87071	87027	87271	87227
2000	10	87072	87028	87272	87228
	15	87073	87029	87273	87229
	30	87074	87030	87274	87230
2500	10	87076	87032	87276	87232
	15	87077	87033	87277	87233
	30	87078	87034	87278	87234
	45	87079		87279	
3000	10	87081	87036	87281	87236
	15	87082	87037	87282	87237
	30	87083	87038	87283	87238
	45	87084		87284	
4000	10	87085	87040	87285	87240
	15	87086	87041	87286	87241
	30	87087	87042	87287	87242
	45	87088		87288	
5000	10	87089	87044	87289	87244
	15	87090	87045	87290	87245
	30	87091	87046	87291	87246
	45	87092		87292	
6000	10	87093	87048	87293	87248
	15	87094	87049	87294	87249
	30	87095	87050	87295	87250
	45	87096		87296	

		Best.-Nr.
	Schnappbefestigung	-
	Plombierplatte Form C	59042

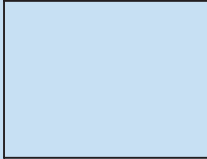

Aufsteck-Stromwandler

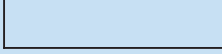
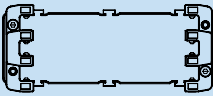
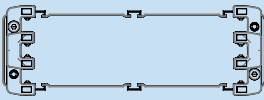
ASK 128.4	Primärleiter Rundleiter Wandlerbreite		128 x 38 mm Ø 38 mm 100 mm
ASK 129.10	Primärleiter Rundleiter Wandlerbreite		120 x 90 mm Ø 90 mm 250 mm
ASK 130.3	Primärleiter Rundleiter Wandlerbreite		130 x 25 mm Ø 25 mm 180 mm
ASK 130.5	Primärleiter Rundleiter Wandlerbreite		130 x 30 mm Ø 30 mm 180 mm
ASK 165.5	Primärleiter Rundleiter Breite		190 x 30 mm 3 x 160 x 10 mm Ø 30 mm 266 mm
ASK 205.5	Primärleiter Rundleiter Breite		230 x 60 mm 3 x 200 x 10 mm Ø 60 mm 306 mm



ASK 128.4

Aufsteck-Stromwandler



Schiene 1	128 x 38 mm
Rundleiter	38 mm
Baubreite	100 mm
Bauhöhe	175 mm
Bautiefe gesamt	58 mm

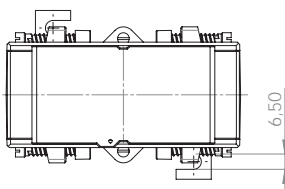
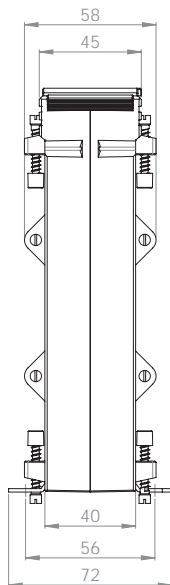
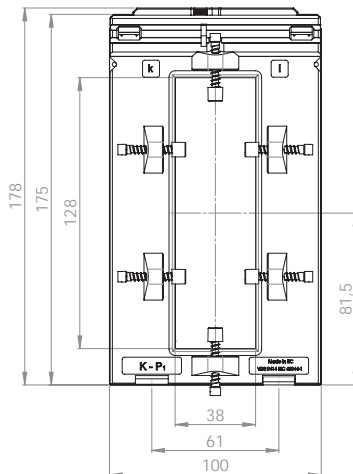

Primärstrom [A]	Bürde [VA]	Sekundärstrom [A] / Klasse			
		5 A Kl. 1 Best.-Nr.	5 A Kl. 0,5 Best.-Nr.	1 A Kl. 1 Best.-Nr.	1 A Kl. 0,5 Best.-Nr.
400	2,5	94041	94011	94241	94211
	5	94042		94242	
500	2,5	94043	94013	94243	94213
	5	94044		94244	
600	2,5	94045	94015	94245	94215
	5	94046		94246	
750	2,5	94047	94017	94247	94217
	5	94048		94248	
800	5	94049	94019	94249	94219
	10	94050		94250	
1000	10	94051	94021	94251	94221
	15	94052		94252	
1200	10	94053	94023	94253	94223
	15	94054		94254	
1250	10	94055	94025	94255	94225
	15	94056		94256	
1500	15	94057	94027	94257	94227
	30	94058		94258	
2000	15	94059	94029	94259	94229
	30	94060		94260	
2500	15	94061	94031	94261	94231
	30	94062		94262	

		Best.-Nr.
	Schnappbefestigung	–
	Plombierplatte Form C	59042



ASK 129.10

Aufsteck-Stromwandler



Schiene 1	120 x 90 mm
Rundleiter	90 mm
Baubreite	250 mm
Bauhöhe	247 mm
Bautiefe gesamt	118 mm

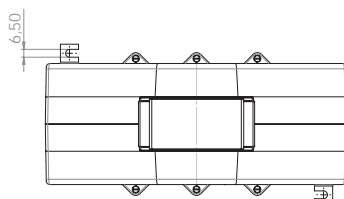
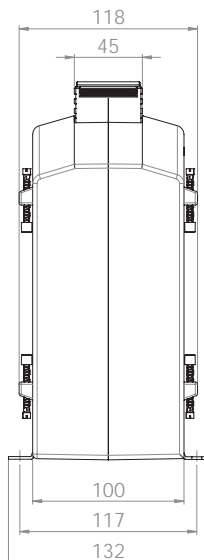
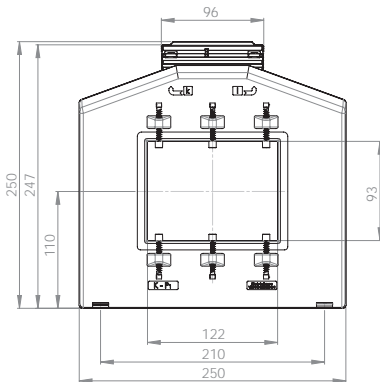

Primärstrom [A]	Bürde [VA]	Sekundärstrom [A] / Klasse			
		5 A Kl. 1 Best.-Nr.	5 A Kl. 0,5 Best.-Nr.	1 A Kl. 1 Best.-Nr.	1 A Kl. 0,5 Best.-Nr.
1000	5	88070	88011	88270	88211
	10	88071	88012	88271	88212
	15	88072	88013	88272	88213
1200	5	88073	88014	88273	88214
	10	88074	88015	88274	88215
	15	88075		88275	
1250	5	88076	88017	88276	88217
	10	88077	88018	88277	88218
	15	88078		88278	
1500	10	88079	88020	88279	88220
	15	88080	88021	88280	88221
	30	88081	88022	88281	88222
1600	10	88082	88023	88282	88223
	15	88083	88024	88283	88224
	30	88084	88025	88284	88225
1800	10	88085	88026	88285	88226
	15	88086	88027	88286	88227
	30	88087	88028	88287	88228
2000	10	88088	88029	88288	88229
	15	88089	88030	88289	88230
	30	88090	88031	88290	88231
2500	15	88091	88032	88291	88232
	30	88092	88033	88292	88233
	45	88093		88293	
3000	15	88094	88035	88294	88235
	30	88095	88036	88295	88236
	45	88096		88296	
4000	15	88097	88038	88297	88238
	30	88098	88039	88298	88239
	45	88099	88040	88299	88240
5000	15	88100	88041	88300	88241
	30	88101	88042	88301	88242
	45	88102	88043	88302	88243
6000	15	88103	88044	88303	88244
	30	88104	88045	88304	88245
	45	88105	88046	88305	88246
7500	15	88106	88047	88306	88247
	30	88107	88048	88307	88248
	45	88108	88049	88308	88249

		Best.-Nr.
	Schnappbefestigung	-
	Plombierplatte Form C	59042



MBS AG



ASK 130.3

Aufsteck-Stromwandler



Schiene 1 130 x 25 mm
 Rundleiter 25 mm
 Baubreite 180 mm
 Bauhöhe 100 mm
 Bautiefe gesamt 50 mm

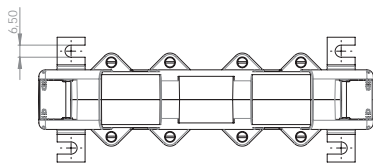
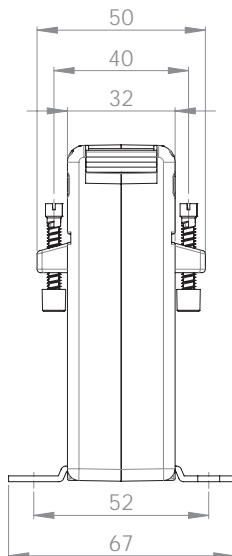
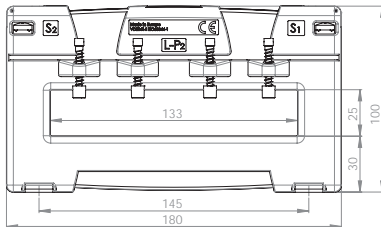

Primärstrom [A]	Bürde [VA]	Sekundärstrom [A] / Klasse				
		5 A Kl. 1 Best.-Nr.	5 A Kl. 0,5 Best.-Nr.	5 A Kl. 0,2s Best.-Nr.	1 A Kl. 1 Best.-Nr.	1 A Kl. 0,5 Best.-Nr.
300	2,5	I50-1900D	I50-1901D		I50-1910D	I50-1911D
	5	I50-1900F	I50-1901F		I50-1910F	I50-1911F
400	2,5	I50-2000D	I50-2001D		I50-2010D	I50-2011D
	5	I50-2000F	I50-2001F		I50-2010F	I50-2011F
	10	I50-2000H			I50-2010H	
500	2,5	I50-2100D	I50-2101D		I50-2110D	I50-2111D
	5	I50-2100F	I50-2101F		I50-2110F	I50-2111F
	10	I50-2100H	I50-2101H		I50-2110H	I50-2111H
600	2,5	I50-2200D	I50-2201D		I50-2210D	I50-2211D
	5	I50-2200F	I50-2201F		I50-2210F	I50-2211F
	10	I50-2200H	I50-2201H		I50-2210H	I50-2211H
	15	I50-2200J			I50-2210J	
750	2,5	I50-2300D	I50-2301D	V50-2304D	I50-2310D	I50-2311D
	5	I50-2300F	I50-2301F		I50-2310F	I50-2311F
	10	I50-2300H	I50-2301H		I50-2310H	I50-2311H
	15	I50-2300J	I50-2301J		I50-2310J	I50-2311J
1000	5	I50-2500F	I50-2501F	V50-2504F	I50-2510F	I50-2511F
	10	I50-2500H	I50-2501H	V50-2504H	I50-2510H	I50-2511H
	15	I50-2500J	I50-2501J		I50-2510J	I50-2511J
	30	I50-2500L			I50-2510L	
1200	5	I50-2600F	I50-2601F	V50-2604F	I50-2610F	I50-2611F
	10	I50-2600H	I50-2601H	V50-2604H	I50-2610H	I50-2611H
	15	I50-2600J	I50-2601J		I50-2610J	I50-2611J
	30	I50-2600L			I50-2610L	
1250	5	I50-2700F	I50-2701F	V50-2704F	I50-2710F	I50-2711F
	10	I50-2700H	I50-2701H	V50-2704H	I50-2710H	I50-2711H
	15	I50-2700J	I50-2701J	V50-2704J	I50-2710J	I50-2711J
	30	I50-2700L			I50-2710L	
1500	5	I50-2800F	I50-2801F	V50-2804F	I50-2810F	I50-2811F
	10	I50-2800H	I50-2801H	V50-2804H	I50-2810H	I50-2811H
	15	I50-2800J	I50-2801J	V50-2804J	I50-2810J	I50-2811J
	30	I50-2800L	I50-2801L		I50-2810L	I50-2811L
1600	5	I50-2900F	I50-2901F	V50-2904F	I50-2910F	I50-2911F
	10	I50-2900H	I50-2901H	V50-2904H	I50-2910H	I50-2911H
	15	I50-2900J	I50-2901J	V50-2904J	I50-2910J	I50-2911J
	30	I50-2900L	I50-2901L		I50-2910L	I50-2911L

		Best.-Nr.
	Schnappbefestigung	–
	Plombierplatte	–



ASK 130.5

Aufsteck-Stromwandler



Schiene 1 130 x 30 mm
 Rundleiter 30 mm
 Baubreite 180 mm
 Bauhöhe 120 mm
 Bautiefe gesamt 68 mm

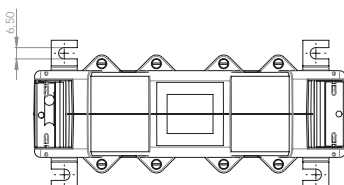
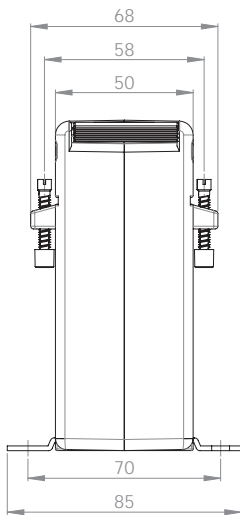
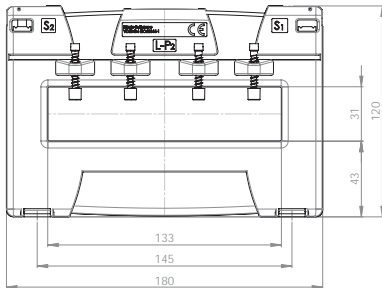

Primärstrom [A]	Bürde [VA]	Sekundärstrom [A] / Klasse				
		5 A Kl. 1 Best.-Nr.	5 A Kl. 0,5 Best.-Nr.	5 A Kl. 0,2s Best.-Nr.	1 A Kl. 1 Best.-Nr.	1 A Kl. 0,5 Best.-Nr.
300	2,5	I51-1900D	I51-1901D		I51-1910D	I51-1911D
	5	I51-1900F	I51-1901F		I51-1910F	I51-1911F
	10	I51-1900H	I51-1901H		I51-1910H	I51-1911H
400	2,5	I51-2000D	I51-2001D		I51-2010D	I51-2011D
	5	I51-2000F	I51-2001F		I51-2010F	I51-2011F
	10	I51-2000H	I51-2001H		I51-2010H	I51-2011H
500	2,5	I51-2100D	I51-2101D		I51-2110D	I51-2111D
	5	I51-2100F	I51-2101F		I51-2110F	I51-2111F
	10	I51-2100H	I51-2101H		I51-2110H	I51-2111H
600	15	I51-2100J	I51-2101J		I51-2110J	I51-2111J
	5	I51-2200F	I51-2201F		I51-2210F	I51-2211F
	10	I51-2200H	I51-2201H		I51-2210H	I51-2211H
750	15	I51-2200J	I51-2201J		I51-2210J	I51-2211J
	5	I51-2300F	I51-2301F	V51-2304F	I51-2310F	I51-2311F
	10	I51-2300H	I51-2301H		I51-2310H	I51-2311H
1000	15	I51-2300J	I51-2301J		I51-2310J	I51-2311J
	5	I51-2500F	I51-2501F	V51-2504F	I51-2510F	I51-2511F
	10	I51-2500H	I51-2501H	V51-2504H	I51-2510H	I51-2511H
1200	15	I51-2500J	I51-2501J		I51-2510J	I51-2511J
	30	I51-2500L	I51-2501L		I51-2510L	I51-2511L
	5	I51-2600F	I51-2601F	V51-2604F	I51-2610F	I51-2611F
1250	10	I51-2600H	I51-2601H	V51-2604H	I51-2610H	I51-2611H
	15	I51-2600J	I51-2601J	V51-2604J	I51-2610J	I51-2611J
	30	I51-2600L	I51-2601L		I51-2610L	I51-2611L
1500	5	I51-2700F	I51-2701F	V51-2704F	I51-2710F	I51-2711F
	10	I51-2700H	I51-2701H	V51-2704H	I51-2710H	I51-2711H
	15	I51-2700J	I51-2701J	V51-2704J	I51-2710J	I51-2711J
1600	30	I51-2700L	I51-2701L		I51-2710L	I51-2711L
	5	I51-2800F	I51-2801F	V51-2804F	I51-2810F	I51-2811F
	10	I51-2800H	I51-2801H	V51-2804H	I51-2810H	I51-2811H
2000	15	I51-2800J	I51-2801J	V51-2804J	I51-2810J	I51-2811J
	30	I51-2800L	I51-2801L		I51-2810L	I51-2811L
	5	I51-2900F	I51-2901F	V51-2904F	I51-2910F	I51-2911F
2400	10	I51-2900H	I51-2901H	V51-2904H	I51-2910H	I51-2911H
	15	I51-2900J	I51-2901J	V51-2904J	I51-2910J	I51-2911J
	30	I51-2900L	I51-2901L		I51-2910L	I51-2911L
2500	10	I51-3000H	I51-3001H	V51-3004H	I51-3010H	I51-3011H
	15	I51-3000J	I51-3001J	V51-3004J	I51-3010J	I51-3011J
	30	I51-3000L	I51-3001L		I51-3010L	I51-3011L
3000	10	I51-3100H	I51-3101H	V51-3104H	I51-3110H	I51-3111H
	15	I51-3100J	I51-3101J	V51-3104J	I51-3110J	I51-3111J
	30	I51-3100L	I51-3101L		I51-3110L	I51-3111L
3200	10	I51-3200H	I51-3201H	V51-3204H	I51-3210H	I51-3211H
	15	I51-3200J	I51-3201J	V51-3204J	I51-3210J	I51-3211J
	30	I51-3200L	I51-3201L	V51-3204L	I51-3210L	I51-3211L
3200	10	I51-3300H	I51-3301H	V51-3304H	I51-3310H	I51-3311H
	15	I51-3300J	I51-3301J	V51-3304J	I51-3310J	I51-3311J
	30	I51-3300L	I51-3301L	V51-3304L	I51-3310L	I51-3311L
3200	10	I51-3400H	I51-3401H	V51-3404H	I51-3410H	I51-3411H
	15	I51-3400J	I51-3401J	V51-3404J	I51-3410J	I51-3411J
	30	I51-3400L	I51-3401L	V51-3404L	I51-3410L	I51-3411L

		Best.-Nr.
	Schnappbefestigung	-
	Plombierplatte	-



ASK 165.5

Aufsteck-Stromwandler



Wählbare Sekundärklemmenpositionen ermöglichen flexible Einbaulagen.

Schiene 1	190 x 60 mm
Schiene 2	3 x 160 x 10 mm
Baubreite	266 mm
Bauhöhe	192 mm
Bautiefe gesamt	100 mm

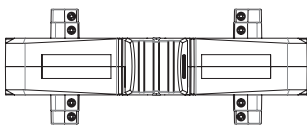
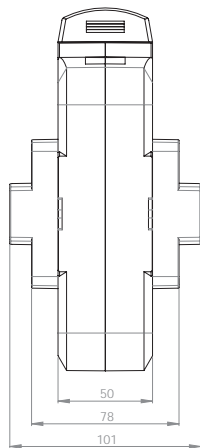
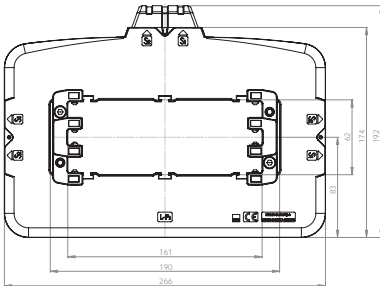

Primärstrom [A]	Bürde [VA]	Sekundärstrom [A] / Klasse		
		5 A Kl. 1 Best.-Nr.	5 A Kl. 0,5 Best.-Nr.	5 A Kl. 0,2 Best.-Nr.
1000	5	1650006021-x	1650005001-x	1650003001-x
	10	1650006022-x	1650005002-x	
	15	1650006001-x		
1200	5	1650006023-x	1650005003-x	1650003003-x
	10	1650006024-x	1650005004-x	1650003004-x
	15	1650006002-x	1650005022-x	
1250	5	1650006025-x	1650005023-x	1650003005-x
	10	1650006026-x	1650005030-x	1650003006-x
	15	1650006003-x	1650005024-x	
1500	10	1650006027-x	1650005005-x	1650003007-x
	15	1650006028-x	1650005006-x	
	30	1650006004-x	1650005025-x	
1600	10	1650006029-x	1650005007-x	1650003008-x
	15	1650006030-x	1650005008-x	
	30	1650006005-x	1650005026-x	
2000	10	1650006031-x	1650005009-x	1650003009-x
	15	1650006032-x	1650005010-x	1650003020-x
	30	1650006006-x	1650005011-x	
	45	1650006007-x		
2500	15	1650006033-x	1650005027-x	1650003010-x
	30	1650006034-x	1650005012-x	
	60	1650006008-x		
3000	15	1650006035-x	1650005028-x	1650003012-x
	30	1650006020-x	1650005013-x	1650003013-x
	60	1650006009-x		
4000	30	1650006036-x	1650005015-x	1650003015-x
	40	1650006037-x		
	60	1650006011-x		

		Best.-Nr.
	Spannpratze Set	59090



ASK 165.5

Aufsteck-Stromwandler



Die Sekundärausleitungen des Stromwandlertyps ASK 165.5 können optional in 3 verschiedenen Positionen ausgeführt werden. Bitte gewünschte Anschlussbelegung bei der Bestellung mit angeben.

Spannpratze ist optional lieferbar. Wenn gewünscht, bitte ebenfalls bei der Bestellung angeben.

Anschlussbelegung

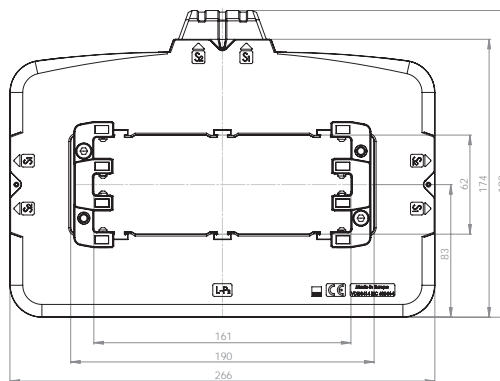
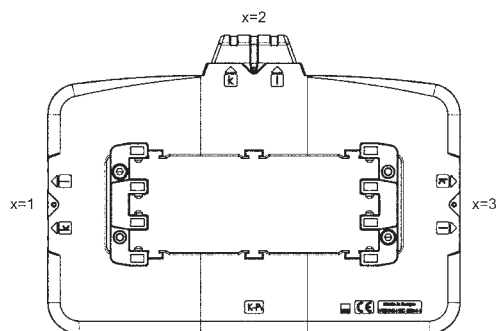

Bestellbeispiel

ASK 165.5 1500/5A 10VA KI.1

Anschlussbelegung oben

Best.-Nr. 1650006027-2



ASK 165.5

Aufsteck-Stromwandler



Wählbare Sekundärklemmenpositionen ermöglichen flexible Einbaulagen.

Schiene 1	190 x 60 mm
Schiene 2	3 x 160 x 10 mm
Baubreite	266 mm
Bauhöhe	192 mm
Bautiefe gesamt	100 mm

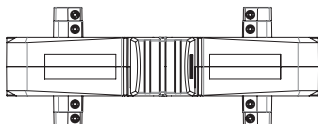
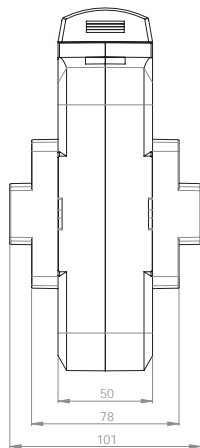
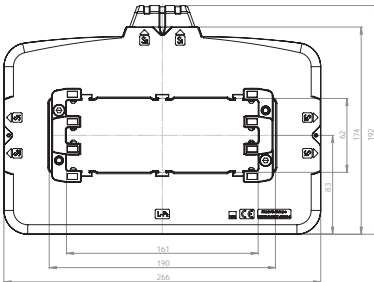

Primärstrom [A]	Bürde [VA]	Sekundärstrom [A] / Klasse		
		1 A Kl. 1 Best.-Nr.	1 A Kl. 0,5 Best.-Nr.	1 A Kl. 0,2 Best.-Nr.
1000	5	1650206021-x	1650205001-x	1650203001-x
	10	1650206022-x	1650205002-x	
	15	1650206001-x		
1200	5	1650206023-x	1650205004-x	1650203003-x
	10	1650206024-x	1650205005-x	1650203004-x
	15	1650206002-x	1650205024-x	
1250	5	1650206025-x	1650205025-x	1650203005-x
	10	1650206026-x	1650205006-x	1650203006-x
	15	1650206003-x	1650205026-x	
1500	10	1650206027-x	1650205007-x	1650203007-x
	15	1650206028-x	1650205008-x	
	30	1650206004-x	1650205027-x	
1600	10	1650206029-x	1650205009-x	1650203008-x
	15	1650206030-x	1650205010-x	
	30	1650206005-x	1650205028-x	
2000	10	1650206031-x	1650205011-x	1650203009-x
	15	1650206032-x	1650205012-x	1650203020-x
	30	1650206006-x	1650205013-x	
	45	1650206007-x		
2500	15	1650206033-x	1650205029-x	1650203010-x
	30	1650206034-x	1650205014-x	
	60	1650206008-x		
3000	15	1650206035-x	1650205030-x	1650203011-x
	30	1650206036-x	1650205015-x	1650203012-x
	60	1650206009-x		
4000	30	1650206037-x	1650205017-x	1650203014-x
	40	1650206038-x		
	60	1650206011-x		

		Best.-Nr.
	Spannpratze Set	59090



ASK 165.5

Aufsteck-Stromwandler



Die Sekundärausleitungen des Stromwandlertyps ASK 165.5 können optional in 3 verschiedenen Positionen ausgeführt werden. Bitte gewünschte Anschlussbelegung bei der Bestellung mit angeben.

Spannpratze ist optional lieferbar. Wenn gewünscht, bitte ebenfalls bei der Bestellung angeben.

Anschlussbelegung

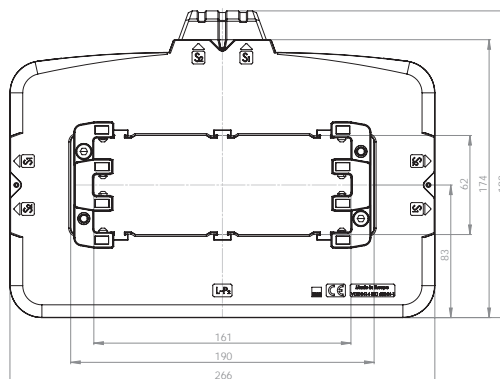
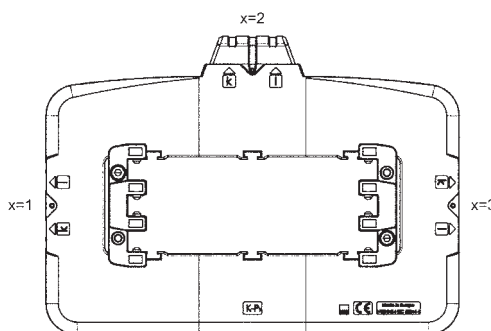

Bestellbeispiel

ASK 165.5 1500/5A 10VA KI.1

Anschlussbelegung oben

Best.-Nr. 1650006027-2



MBS AG



ASK 205.5

Aufsteck-Stromwandler



Wählbare Sekundärklemmenpositionen ermöglichen flexible Einbaulagen.

Schiene 1	230 x 60 mm
Schiene 2	3 x 200 x 10 mm
Baubreite	306 mm
Bauhöhe	192 mm
Bautiefe gesamt	100 mm

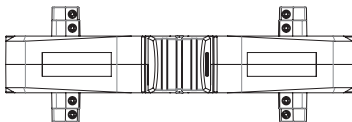
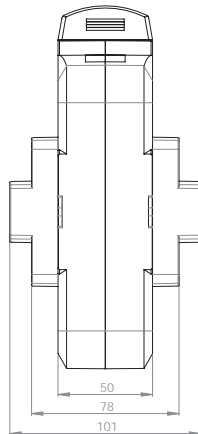
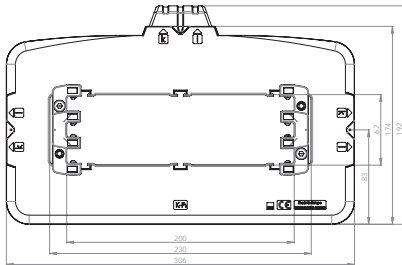

Primärstrom [A]	Bürde [VA]	Sekundärstrom [A] / Klasse		
		5 A Kl. 1 Best.-Nr.	5 A Kl. 0,5 Best.-Nr.	5 A Kl. 0,2 Best.-Nr.
1200	5	2050006023-x	2050005023-x	2050003001-x
	10	2050006024-x	2050005001-x	
	15	2050006001-x	2050005024-x	
1250	5	2050006025-x	2050005025-x	2050003003-x
	10	2050006026-x	2050005002-x	2050003004-x
	15	2050006002-x	2050005026-x	
1500	5	2050006027-x	2050005027-x	2050003005-x
	10	2050006028-x	2050005003-x	2050003006-x
	15	2050006003-x	2050005004-x	2050003007-x
	30	2050006004-x		
1600	5	2050006029-x	2050005028-x	2050003008-x
	10	2050006030-x	2050005029-x	2050003009-x
	15	2050006005-x	2050005005-x	2050003010-x
	30	2050006006-x		
2000	10	2050006031-x	2050005030-x	2050003011-x
	15	2050006032-x	2050005006-x	2050003012-x
	30	2050006007-x	2050005007-x	
2500	10	2050006033-x	2050005031-x	2050003013-x
	15	2050006034-x	2050005008-x	2050003014-x
	30	2050006035-x	2050005009-x	
3000	10	2050006036-x	2050005032-x	2050003015-x
	15	2050006037-x	2050005010-x	2050003016-x
	30	2050006038-x	2050005011-x	2050003017-x
	45	2050006009-x		
4000	15	2050006039-x	2050005033-x	2050003019-x
	30	2050006010-x	2050005012-x	2050003020-x
	60	2050006011-x		
5000	15	2050006040-x	2050005034-x	2050003021-x
	30	2050006013-x	2050005014-x	2050003022-x
	60	2050006014-x		

	Best.-Nr.
	Spannpratze Set 59090

ASK 205.5

Aufsteck-Stromwandler



Die Sekundärausleitungen des Stromwandlertyps ASK 205.5 können optional in 3 verschiedenen Positionen ausgeführt werden. Bitte gewünschte Anschlussbelegung bei der Bestellung mit angeben.

Spannpratze ist optional lieferbar. Wenn gewünscht, bitte ebenfalls bei der Bestellung angeben.

Anschlussbelegung

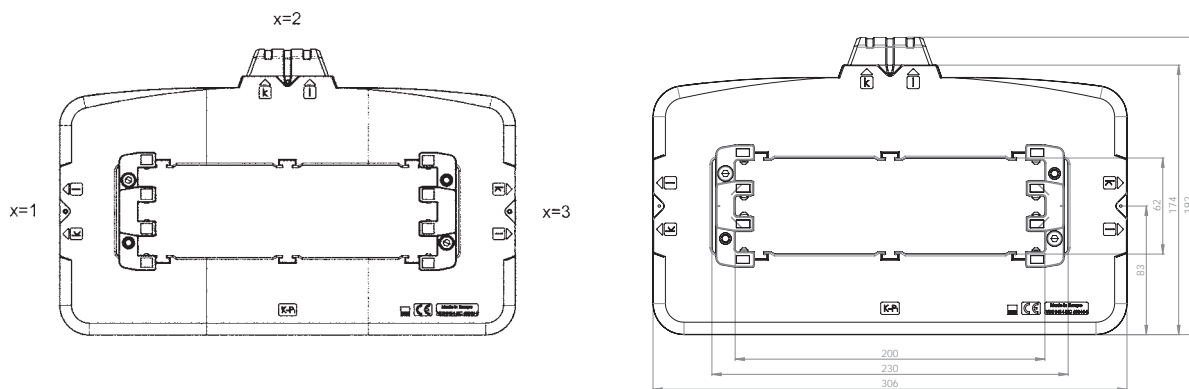

Bestellbeispiel

ASK 205.5 1500/5A 10VA KI.1

Anschlussbelegung oben

Best.-Nr. 2050006028-2



ASK 205.5

Aufsteck-Stromwandler



Wählbare Sekundärklemmenpositionen ermöglichen flexible Einbaulagen.

Schiene 1	230 x 60 mm
Schiene 2	3 x 200 x 10 mm
Baubreite	306 mm
Bauhöhe	192 mm
Bautiefe gesamt	100 mm

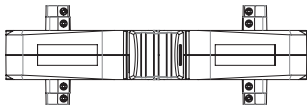
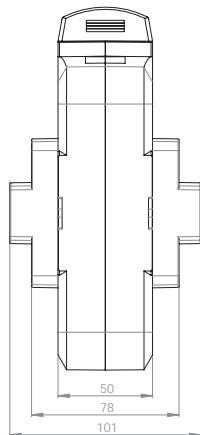
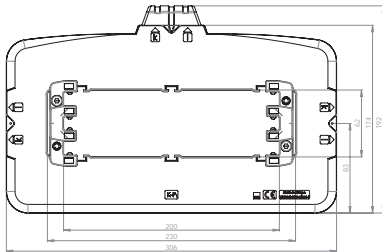

Primärstrom [A]	Bürde [VA]	Sekundärstrom [A] / Klasse		
		1 A Kl. 1 Best.-Nr.	1 A Kl. 0,5 Best.-Nr.	1 A Kl. 0,2 Best.-Nr.
1200	5	2050206023-x	2050205023-x	2050203001-x
	10	2050206024-x	2050205001-x	
	15	2050206001-x	2050205024-x	
1250	5	2050206025-x	2050205025-x	2050203003-x
	10	2050206026-x	2050205002-x	2050203004-x
	15	2050206002-x	2050205026-x	
1500	5	2050206027-x	2050205027-x	2050203005-x
	10	2050206028-x	2050205503-x	2050203006-x
	15	2050206003-x	2050205004-x	2050203007-x
	30	2050206004-x		
1600	10	2050206029-x	2050205028-x	2050203009-x
	15	2050206005-x	2050205005-x	2050203010-x
	30	2050206006-x		
2000	10	2050206030-x	2050205029-x	2050203011-x
	15	2050206031-x	2050205006-x	2050203012-x
	30	2050206007-x	2050205007-x	
2500	10	2050206032-x	2050205030-x	2050203013-x
	15	2050206033-x	2050205508-x	2050203014-x
	30	2050206034-x	2050205009-x	
3000	10	2050206035-x	2050205031-x	2050203015-x
	15	2050206036-x	2050205010-x	2050203016-x
	30	2050206037-x	2050205011-x	2050203017-x
	45	2050206009-x		
4000	15	2050206038-x	2050205032-x	2050203019-x
	30	2050206010-x	2050205012-x	2050203020-x
	60	2050206011-x		
5000	15	2050206039-x	2050205033-x	2050203021-x
	30	2050206013-x	2050205014-x	2050203022-x
	60	2050206014-x		

	Best.-Nr.
	Spannpratze Set 59090

ASK 205.5

Aufsteck-Stromwandler



Die Sekundärausleitungen des Stromwandlertyps ASK 205.5 können optional in 3 verschiedenen Positionen ausgeführt werden. Bitte gewünschte Anschlussbelegung bei der Bestellung mit angeben.

Spannpratze ist optional lieferbar. Wenn gewünscht, bitte ebenfalls bei der Bestellung angeben.

Anschlussbelegung

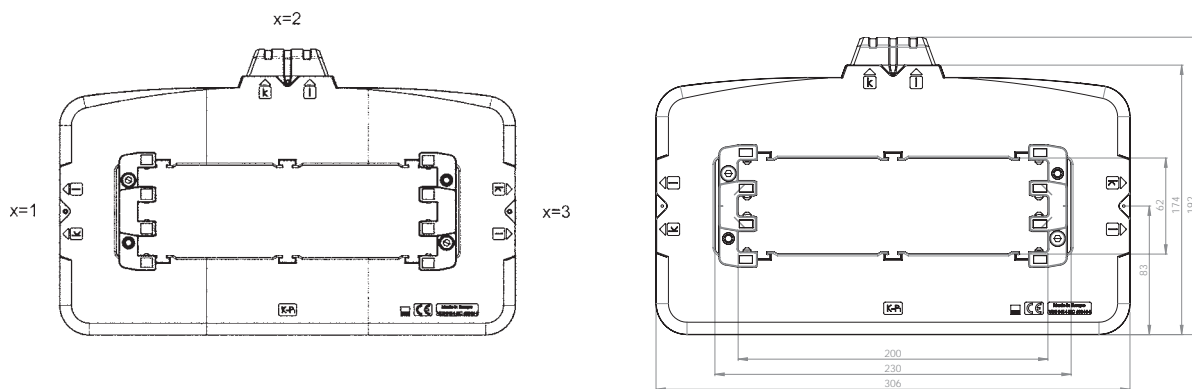

Bestellbeispiel

ASK 205.5 1500/5A 10VA KI.1

Anschlussbelegung oben

Best.-Nr. 2050006028-2





Niederspannungs-Stromwandler für Industrie

Wickel-Stromwandler

WSK 30	Wandlerbreite	61 mm
WSK 40	Wandlerbreite	71 mm
WSK 40N	Wandlerbreite	71 mm
WSK 60	Wandlerbreite	71 mm
WSK 70.6N	Wandlerbreite	60 mm
WSK 31.5	Wandlerbreite	70 mm



Wickel-Stromwandler

Hervorgerufen durch das physikalische Wirkprinzip von Stromwandlern, steigt mit sinkenden primären Nennströmen, das zur Übertragung einer bestimmten Leistung erforderliche Messkernvolumen stark an. Da einer Vergrößerung der geometrischen Abmessungen des Stromwandlers beim Anwender Grenzen gesetzt sind, werden für niedrige primäre Bemessungsstromstärken sogenannte Wickel-Stromwandler eingesetzt.

Zur Gruppe der Wickel-Stromwandler werden auch sogenannte Zwischenstromwandler gezählt. Zwischenstromwandler werden für primäre Bemessungsstromstärken bis ca. 10 A gefertigt und ermöglichen die proportionale Umwandlung des Eingangstromes auf kleinere, bzw. größere sekundäre Bemessungsstromstärken. Bei sachgerechter Auslegung ihrer Messsysteme, ermöglichen sie die Übertragung analoger Messwerte über große Wegstrecken, sowie einen sicheren Schutz nachgeschalteter Messgeräte bei Überstromzuständen im Primärnetz. Die Vergrößerung möglicher Signalübertragungsstrecken wird durch eine, mit sinkenden Sekundärströmen einhergehende, Senkung der Leitungsverluste erreicht.

$$P_V [W] = I_s^2 \times R_L$$

Darin bedeuten: P_V Verlustleistung in Watt
 I_s sekundäre Bemessungsstromstärke des Stromwandlers in Ampere
 R_L Leitungswiderstand der sekundären Anschlussleitungen in Ohm
 (Achtung: Leitungswiderstand von Hin- und Rückleiter!)

Abgeleitet aus dieser Formel kann festgestellt werden, dass durch eine Halbierung des ursprünglichen Sekundärstromes, eine Reduzierung der Leistungsverluste auf 25 % des ursprünglichen Wertes erzielt werden kann.

Hinweis: Da ein Zwischenstromwandler im Sekundärkreis eines Hauptwandlers eine zusätzliche induktive Last darstellt, muss dessen Eigenleistungsbedarf bei der korrekten Auswahl des Hauptwandlers berücksichtigt werden.

Zur korrekten Leistungsbemessung des einzusetzenden Hauptwandlers, verwenden Sie bitte nachfolgend aufgeführte Formel:

$$P_{GH} [VA] = P_Z \times \left(\frac{I_2}{I_1}\right)^2 + P_E + P_{HZ}$$

Legende: P_{GH} Sekundäre Bemessungs-Scheinleistung des Hauptwandlers
 P_Z Sekundäre Bemessungs-Scheinleistung des Zwischenwandlers
 (Summe aus Leistungsbedarf der angeschlossenen Messgeräte und Leitungsverlusten der Sekundärleitungen)
 P_E Eigenleistungsbedarf des Zwischenwandlers bei Nennstrom
 (typisch: ca. 3 VA)
 P_{HZ} Leitungsverluste zwischen Haupt- und Zwischenwandler
 I_1 Primäre Bemessungs-Stromstärke des Zwischenwandlers
 I_2 Sekundäre Bemessungs-Stromstärke des Zwischenwandlers



WSK 30

Wickel-Stromwandler



Baubreite 61 mm
 Bauhöhe 75,5 mm
 Bautiefe gesamt 35 mm

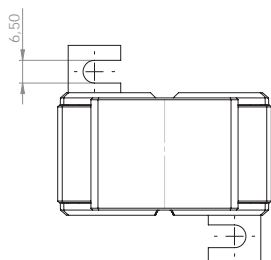
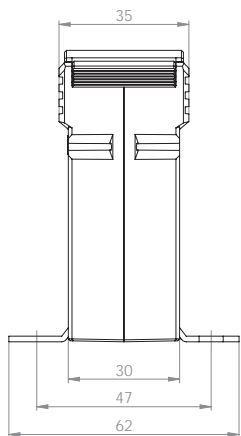
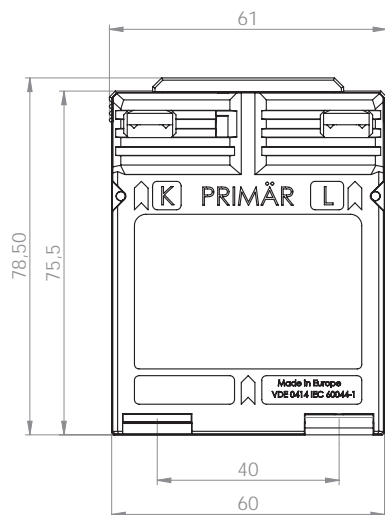

Primärstrom [A]	Bürde [VA]	Sekundärstrom [A] / Klasse			
		5 A Kl. 1 Best.-Nr.	5 A Kl. 0,5 Best.-Nr.	1 A Kl. 1 Best.-Nr.	1 A Kl. 0,5 Best.-Nr.
1	2,5	30017	30011	30217	30211
	5	30018		30218	
2,5	2,5	30019	30012	30219	30212
	5	30020		30220	
5	2,5	30021	30013	30221	30213
	5	30022		30222	
10	2,5	30023	30014	30223	30214
	5	30024		30224	
15	2,5	30025	30015	30225	30215
	5	30026		30226	
20	2,5	30027	30016	30227	30216
	5	30028		30228	

	Best.-Nr.
	Schnappbefestigung Form A 53011
	Plombierplatte Form A 59040

Anschlussquerschnitt primär: max 4 mm² mit Aderendhülse, 6 mm² massiv

ASR

ASG

ASK

WSK

KBR / KBU

KSU / SJSK

NH

SASR / SASK

ASRD

ASKD / WSKD

CTB



WSK 40

Wickel-Stromwandler



Baubreite 71 mm
 Bauhöhe 85,5 mm
 Bautiefe gesamt 45 mm

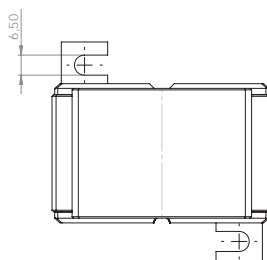
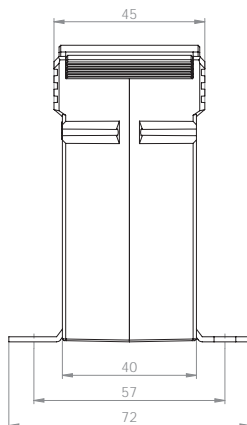
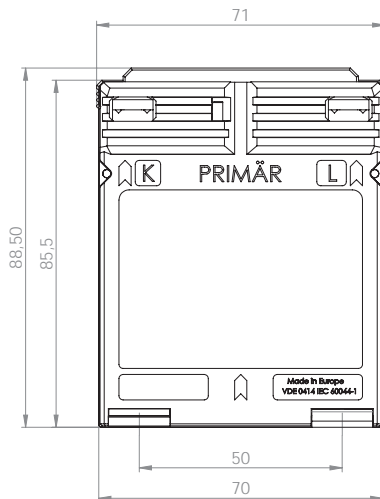

Primärstrom [A]	Bürde [VA]	Sekundärstrom [A] / Klasse			
		5 A Kl. 1 Best.-Nr.	5 A Kl. 0,5 Best.-Nr.	1 A Kl. 1 Best.-Nr.	1 A Kl. 0,5 Best.-Nr.
1	2,5	31044	31011	31244	31211
	5	31045	31012	31245	31212
	10	31046	31013	31246	31213
2,5	2,5	31048	31015	31248	31215
	5	31049	31016	31249	31216
	10	31050	31017	31250	31217
	15			31251	
5	2,5	31052	31019	31252	31219
	5	31053	31020	31253	31220
	10	31054	31021	31254	31221
	15			31255	31222
10	2,5	31056	31023	31256	31223
	5	31057	31024	31257	31224
	10	31058	31025	31258	31225
	15			31259	
15	2,5	31060	31027	31260	31227
	5	31061	31028	31261	31228
	10	31062	31029	31262	31229
	15			31263	
20	2,5	31064	31031	31264	31231
	5	31065	31032	31265	31232
	10	31066	31033	31266	31233
25	2,5	31068	31035	31268	31235
	5	31069	31036	31269	31236
	10	31070	31037	31270	31237
30	2,5	31072	31039	31272	31239
	5	31073	31040	31273	31240
	10	31074	31041	31274	31241

		Best.-Nr.
	Schnappbefestigung Form D	55012
	Plombierplatte Form B	59041

Anschlussquerschnitt primär: max. 4 mm² mit Aderendhülse, 6 mm² massiv,
 max. 8 mm² mit Kabelschuh



WSK 40N

Wickel-Stromwandler



Baubreite 71 mm
 Bauhöhe 107 mm
 Bautiefe gesamt 55 mm

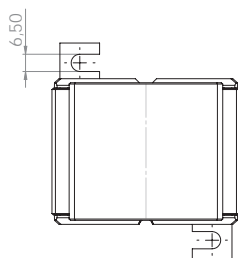
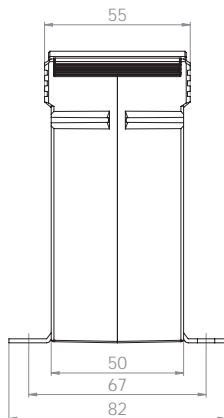
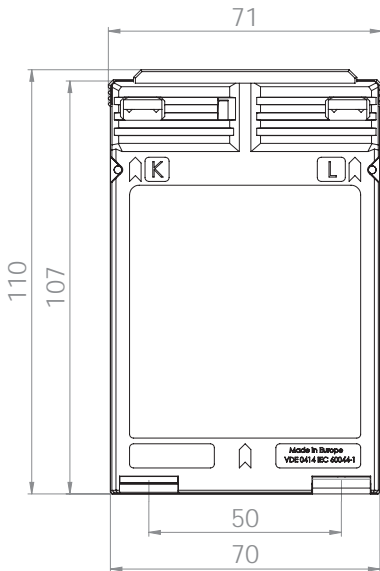

Primärstrom [A]	Bürde [VA]	Sekundärstrom [A] / Klasse			
		5 A Kl. 1 Best.-Nr.	5 A Kl. 0,5 Best.-Nr.	1 A Kl. 1 Best.-Nr.	1 A Kl. 0,5 Best.-Nr.
30	2,5	31161	31151	31361	31351
	5	31162	31152	31362	31352
	10	31163	31153	31363	31353
40	2,5	31164	31154	31364	31354
	5	31165	31155	31365	31355
	10	31166	31156	31366	31356
50	2,5	31167	31157	31367	31357
	5	31168	31158	31368	31358
	10	31169	31159	31369	31359

		Best.-Nr.
	Schnappbefestigung Form C	55011
	Plombierplatte Form B	59041

Anschlussquerschnitt primär: max. 10 mm² mit Kabelschuh

ASR

ASG

ASK

WSK

KBR / KBU

KSU / SJSK

NH

SASR / SASK

ASRD

ASKD / WSKD

CTB



WSK 60

Wickel-Stromwandler



Baubreite 71 mm
 Bauhöhe 88,5 mm
 Bautiefe gesamt 60 mm

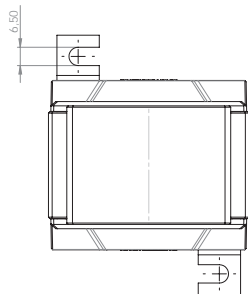
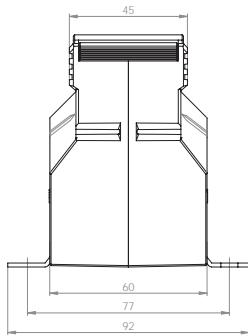
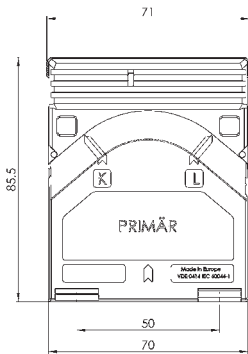

Primärstrom [A]	Bürde [VA]	Sekundärstrom [A] / Klasse			
		5 A Kl. 1 Best.-Nr.	5 A Kl. 0,5 Best.-Nr.	1 A Kl. 1 Best.-Nr.	1 A Kl. 0,5 Best.-Nr.
5	2,5	35041	35011	35241	35211
	5	35042	35012	35242	35212
	10	35043	35013	35243	35213
	15	35044		35244	
10	2,5	35045	35014	35245	35214
	5	35046	35015	35246	35215
	10	35047	35016	35247	35216
	15	35048		35248	
15	2,5	35049	35017	35249	35217
	5	35050	35018	35250	35218
	10	35051	35019	35251	35219
	15	35052		35252	
20	2,5	35053	35020	35253	35220
	5	35054	35021	35254	35221
	10	35055	35022	35255	35222
	15	35056		35256	
25	2,5	35057	35023	35257	35223
	5	35058	35024	35258	35224
	10	35059	35025	35259	35225
	15	35060		35260	
30	2,5	35061	35026	35261	35226
	5	35062	35027	35262	35227
	10	35063	35028	35263	35228
	15	35064		35264	

		Best.-Nr.
	Schnappbefestigung	-
	Plombierplatte Form B	59041

Anschlussquerschnitt primär: max. 4 mm² mit Aderendhülse, 6 mm² massiv, max. 8 mm² mit Kabelschuh



WSK 70.6 N

Wickel-Stromwandler



Baubreite 60 mm
 Bauhöhe 85,5 mm
 Bautiefe gesamt 136 mm

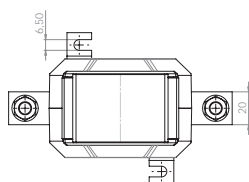
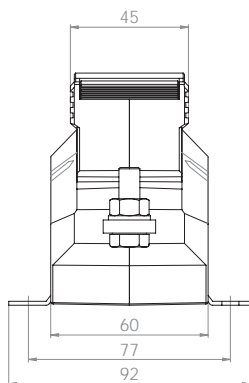
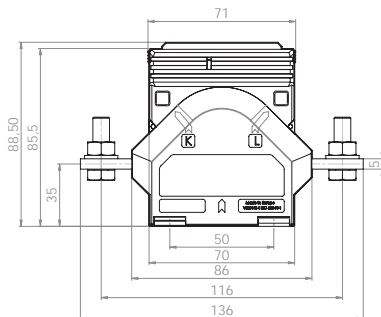

Primärstrom [A]	Bürde [VA]	Sekundärstrom [A] / Klasse			
		5 A Kl. 1 Best.-Nr.	5 A Kl. 0,5 Best.-Nr.	1 A Kl. 1 Best.-Nr.	1 A Kl. 0,5 Best.-Nr.
25	2,5	89047	89011	89247	89211
	5	89048	89012	89248	89212
	10	89049	89013	89249	89213
	15			89250	
30	2,5	89051	89015	89251	89215
	5	89052	89016	89252	89216
	10	89053	89017	89253	89217
	15	89054		89254	
40	2,5	89055	89019	89255	89219
	5	89056	89020	89256	89220
	10	89057	89021	89257	89221
	15	89058		89258	
50	2,5	89059	89023	89259	89223
	5	89060	89024	89260	89224
	10	89061	89025	89261	89225
	15	89062		89262	
60	2,5	89063	89027	89263	89227
	5	89064	89028	89264	89228
	10	89065	89029	89265	89229
	15	89066		89266	
75	2,5	89067	89031	89267	89231
	5	89068	89032	89268	89232
	10	89069	89033	89269	89233
	15	89070		89270	
80	2,5	89071	89035	89271	89235
	5	89072	89036	89272	89236
	10	89073	89037	89273	89237
	15	89074		89274	
100	2,5	89075	89039	89275	89239
	5	89076	89040	89276	89240
	10	89077	89041	89277	89241
	15	89078		89278	

		Best.-Nr.
	Schnappbefestigung	-
	Plombierplatte Form B	59041

Stromwandler mit Primäranschlussleiter 20 x 5 mm, Schraube M8



MBS AG



WSK 31.5

Wickel-Stromwandler



Baubreite 70 mm
 Bauhöhe 100 mm
 Bautiefe gesamt 115 mm

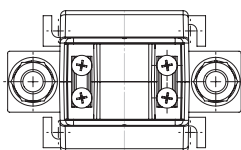
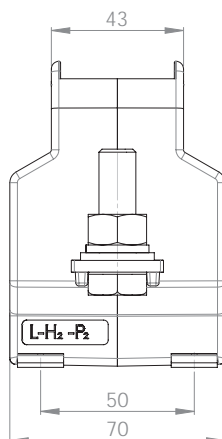
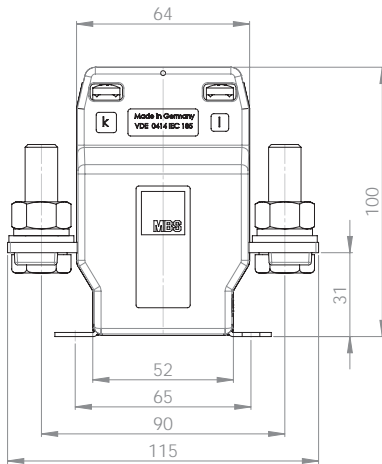

Primärstrom [A]	Bürde [VA]	Sekundärstrom [A] / Klasse			
		5 A Kl. 1 Best.-Nr.	5 A Kl. 0,5 Best.-Nr.	1 A Kl. 1 Best.-Nr.	1 A Kl. 0,5 Best.-Nr.
25	2,5	33047	33011	33247	33211
	5	33048	33012	33248	33212
	10	33049	33013	33249	33213
	15	33050	33014	33250	33214
30	2,5	33051	33015	33251	33215
	5	33052	33016	33252	33216
	10	33053	33017	33253	33217
	15	33054	33018	33254	33218
40	2,5	33055	33019	33255	33219
	5	33056	33020	33256	33220
	10	33057	33021	33257	33221
	15	33058	33022	33258	33222
50	2,5	33059	33023	33259	33223
	5	33060	33024	33260	33224
	10	33061	33025	33261	33225
	15	33062	33026	33262	33226
60	2,5	33063	33027	33263	33227
	5	33064	33028	33264	33228
	10	33065	33029	33265	33229
	15	33066	33030	33266	33230
75	2,5	33067	33031	33267	33231
	5	33068	33032	33268	33232
	10	33069	33033	33269	33233
	15	33070	33034	33270	33234
80	2,5	33071	33035	33271	33235
	5	33072	33036	33272	33236
	10	33073	33037	33273	33237
	15	33074	33038	33274	33238
100	2,5	33075	33039	33275	33239
	5	33076	33040	33276	33240
	10	33077	33041	33277	33241
	15	33078	33042	33278	33242
150	2,5	33079	33043	33279	33243
	5	33080	33044	33280	33244
	10	33081	33045	33281	33245
	15	33082	33046	33282	33246

		Best.-Nr.
	Schnappbefestigung	-
	Plombierplatte Form F	59045

Stromwandler mit Primäranschlussleiter 30 x 5 mm, Schraube M12







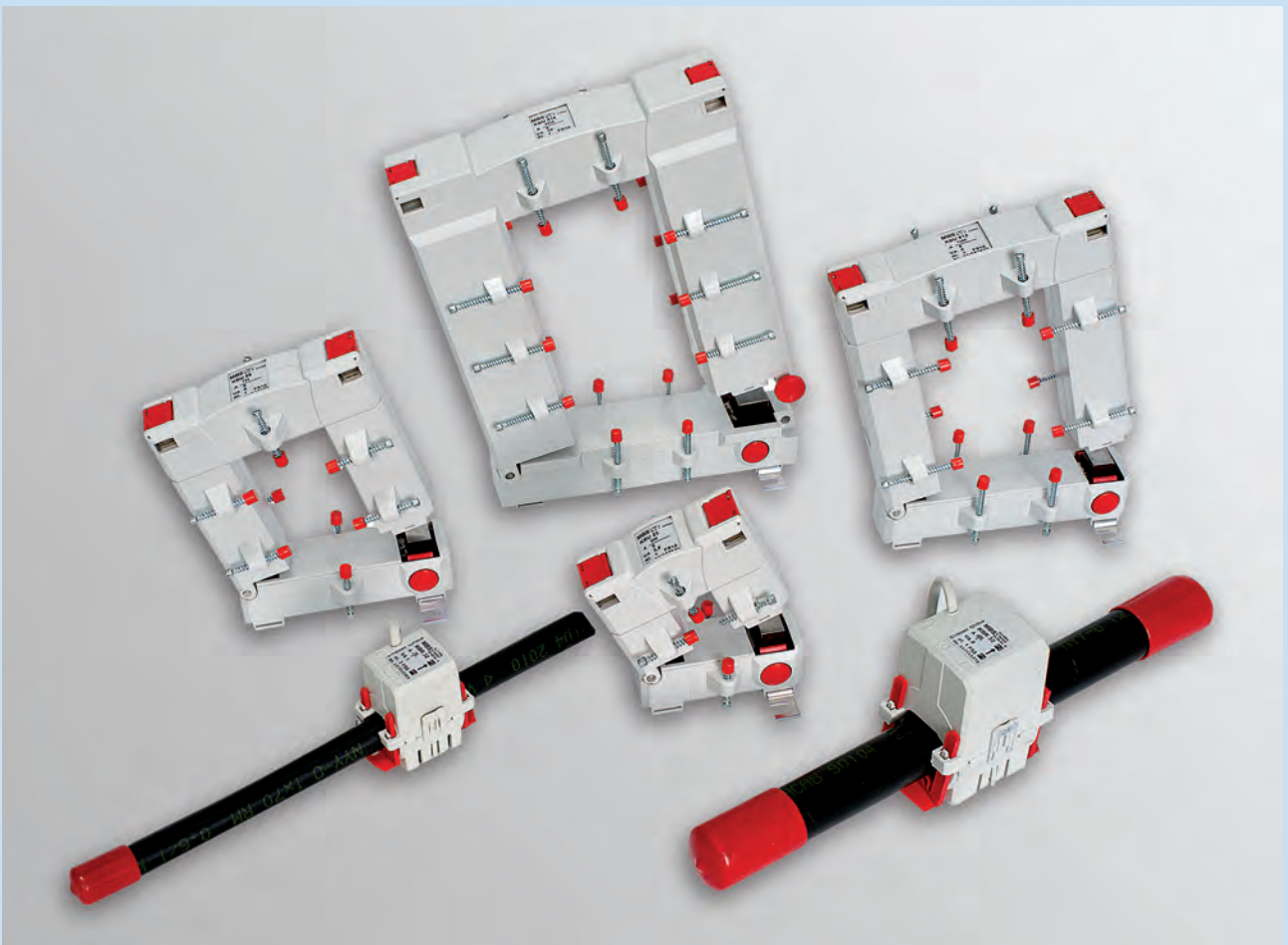

MBS AG



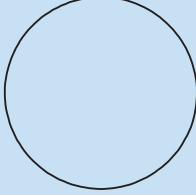
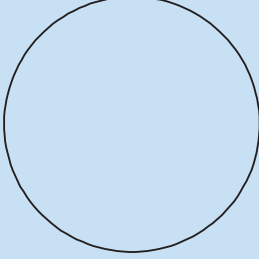

Niederspannungs-Stromwandler für Industrie

KBR 18	Rundleiter Wandlerbreite		18,5 mm 41,6 mm
KBR 32	Rundleiter Wandlerbreite		32,5 mm 59,2 mm
KBR 44	Rundleiter Wandlerbreite		44 mm 72,2 mm
KBU 23	Primärleiter Wandlerbreite		20 x 30 mm 93 mm
KBU 58	Primärleiter Wandlerbreite		50 x 80 mm 125 mm
KBU 812	Primärleiter Wandlerbreite		80 x 120 mm 155 mm
KBU 816	Primärleiter Wandlerbreite		80 x 160 mm 195 mm



KBR 18

Kabelumbau-Stromwandler



Rundleiter	18,5 mm
Baubreite	41,6 mm
Bauhöhe	64,5 mm
Bautiefe gesamt	68 mm

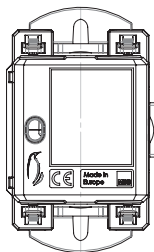
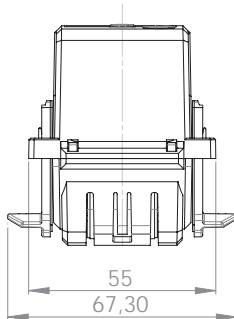
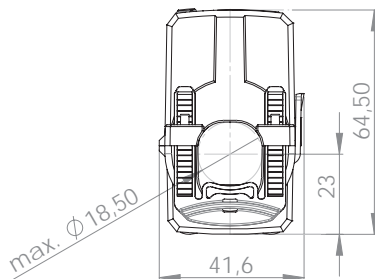

Primärstrom [A]	Bürde [VA]	Sekundärstrom [A] / Klasse	
		1 A Kl. 3 Best.-Nr.	1 A Kl. 1 Best.-Nr.
50	1	18-0001	
75	1	18-0006	
100	1,25	18-0011	
125	1,5	18-0016	
150	2	18-0021	
200	1		18-0027
	3	18-0026	
250	1,5		18-0032
	4	18-0031	

Optional mit Spannungsausgang:

Primärstrom [A]	Spannungsausgang [mV]	Klasse 1
50	0...333	18-1001
75	0...333	18-1006
100	0...333	18-1011
125	0...333	18-1016
150	0...333	18-1021
200	0...333	18-1026
250	0...333	18-1031

- Kabelumbauwandler finden ihr Haupteinsatzgebiet beim nachträglichen Einbau, um das Auftrennen der Primärleiter zu vermeiden.
- Der kompakte Kabelumbauwandler KBR 18 eignet sich aufgrund seiner Abmessungen und des einfachen Handlings besonders für den Einsatz an schwer zugänglichen Stellen oder bei begrenztem Platzangebot.
- Durch das „Klick“-System in Verbindung mit den Fixierspangen ist sogar eine „einhändige“ Montage möglich.
- Standardmäßig erfolgt die Auslieferung mit 2,5 m Anschlussleitung 2 x 0,75 mm² (farblich codiert; S1 = braun; S2 = blau), andere Leitungslängen sind auf Anfrage möglich.
- Für den Einsatz als Stromsensor ist der KBR 18 optional mit 0...333 mV Spannungsausgang erhältlich (min. Bürdenwiderstand ≥ 1 k Ω).
- Arbeitstemperaturbereich: -5 °C < T < +50 °C
- Lagertemperaturbereich: -25 °C < T < +70 °C



KBR 32

Kabelumbau-Stromwandler



Rundleiter	32,5 mm
Baubreite	59,2 mm
Bauhöhe	96,4 mm
Bautiefe gesamt	90 mm

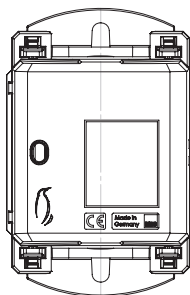
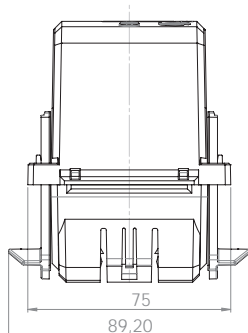
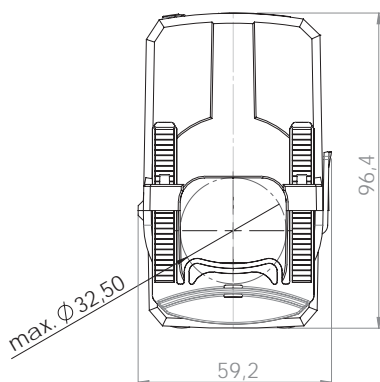

Primärstrom [A]	Bürde [VA]	Sekundärstrom [A] / Klasse			
		5 A Kl. 3 Best.-Nr.	5 A Kl. 1 Best.-Nr.	1 A Kl. 3 Best.-Nr.	1 A Kl. 1 Best.-Nr.
100	1,5	32-5011			
	2,5			32-0011	
125	2,5	32-5016			
	3			32-0016	
150	3	32-5021		32-0021	
	5	32-5026		32-0026	
250	3	32-5031			
	5			32-0031	
300	2,5		32-5035		
	5				32-0035
400	5		32-5037		32-0037
500	5		32-5039		32-0039
600	5		32-5041		32-0041

Primärstrom [A]	Ausgangssignal		Kl. 1 Best.-Nr.
	[mV] AV	[mA] DC	
100	0...333	–	32-1011
	–	4...20	32-2011
125	0...333	–	32-1016
	–	4...20	32-2016
150	0...333	–	32-1021
	–	4...20	32-2021
200	0...333	–	32-1026
	–	4...20	32-2026
250	0...333	–	32-1031
	–	4...20	32-2031
300	0...333	–	32-1034
	–	4...20	32-2034
400	0...333	–	32-1036
	–	4...20	32-2036
500	0...333	–	32-1038
	–	4...20	32-2038
600	0...333	–	32-1040
	–	4...20	32-2040

- Kabelumbauwandler finden ihr Haupteinsatzgebiet beim nachträglichen Einbau, um das Auftrennen der Primärleiter zu vermeiden.
- Der kompakte Kabelumbauwandler KBR 32 eignet sich aufgrund seiner Abmessungen und des einfachen Handlings besonders für den Einsatz an schwer zugänglichen Stellen oder bei begrenztem Platzangebot.
- Durch das „Klick“-System in Verbindung mit den Fixierspannen ist sogar eine „einhändige“ Montage möglich.
- Standardmäßig erfolgt die Auslieferung der Sekundär 1 A - Version mit 2,5 m Anschlussleitung 2 x 0,75 mm² (farblich codiert; S1 = braun; S2 = blau), andere Leitungslängen sind auf Anfrage möglich. Die Sekundär 5 A - Version wird mit einer 0,5 m Anschlussleitung 2 x 1,5 mm² ausgeliefert.
- Für den Einsatz als Stromsensor ist der KBR 32 optional mit 0...333 mV Spannungsausgang erhältlich (min. Bürdenwiderstand ≥ 1 kΩ). Außerdem ist der KBR 32 als Messumformer mit einem Messausgang von 4...20 mA DC erhältlich.
- Arbeitstemperaturbereich: -5 °C < T < +50 °C
- Lagertemperaturbereich: -25 °C < T < +70 °C



KBR 44

Kabelumbau-Stromwandler

Rundleiter	44 mm
Baubreite	72,2 mm
Bauhöhe	120,6 mm
Bautiefe gesamt	98 mm

Primärstrom [A]	Bürde [VA]	Sekundärstrom [A] / Klasse	
		5 A Kl. 1 Best.-Nr.	1 A Kl. 1 Best.-Nr.
250	1,5	44-5001	
	2,5		44-0001
300	2,5	44-5006	44-0006
400	5	44-5011	44-0011
500	5	44-5016	44-0016
600	5	44-5021	44-0021
750	5	44-5026	44-0026
800	5	44-5031	44-0031
1000	5	44-5036	44-0036

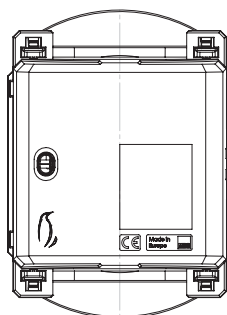
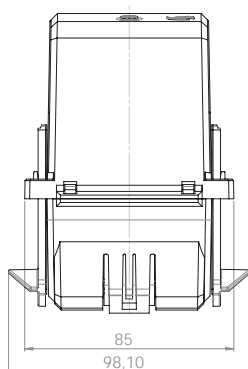
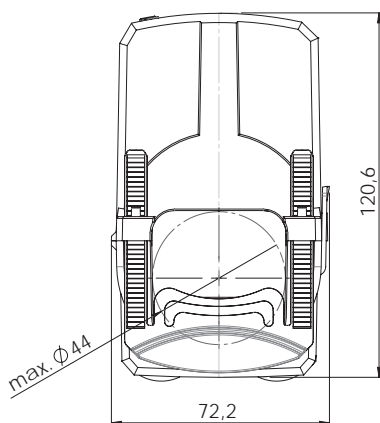

Primärstrom [A]	Ausgangssignal		Kl. 1 Best.-Nr.
	[mV] AV	[mA] DC	
250	0...333	–	44-1001
	–	4...20	44-2001
300	0...333	–	44-1006
	–	4...20	44-2006
400	0...333	–	44-1011
	–	4...20	44-2011
500	0...333	–	44-1016
	–	4...20	44-2016
600	0...333	–	44-1021
	–	4...20	44-2021
750	0...333	–	44-1026
	–	4...20	44-2026
800	0...333	–	44-1031
	–	4...20	44-2031
1000	0...333	–	44-1036
	–	4...20	44-2036

- Kabelumbauwandler finden ihr Haupteinsatzgebiet beim nachträglichen Einbau, um das Auftrennen der Primärleiter zu vermeiden.
- Der kompakte Kabelumbauwandler KBR 44 eignet sich aufgrund seiner Abmessungen und des einfachen Handlings besonders für den Einsatz an schwer zugänglichen Stellen oder bei begrenztem Platzangebot.
- Durch das „Klick“-System in Verbindung mit den Fixierspannen ist sogar eine „einhändige“ Montage möglich.
- Standardmäßig erfolgt die Auslieferung der Sekundär 1 A - Version mit 2,5 m Anschlussleitung 2 x 0,75 mm² (farblich codiert; S1 = braun; S2 = blau), andere Leitungslängen sind auf Anfrage möglich. Die Sekundär 5 A - Version wird mit einer 0,5 m Anschlussleitung 2 x 1,5 mm² ausgeliefert.
- Für den Einsatz als Stromsensor ist der KBR 44 optional mit 0...333 mV Spannungsausgang erhältlich (min. Bürdenwiderstand ≥ 1 kΩ). Außerdem ist der KBR 44 als Messumformer mit einem Messausgang von 4...20 mA DC erhältlich.
- Arbeitstemperaturbereich: -5 °C < T < +50 °C
- Lagertemperaturbereich: -25 °C < T < +70 °C

KBR 32/44

Technische Kennwerte zum KBR mit Ausgangssignal 4...20 mA:

- Zweidrahttechnik, Hilfsspannung über Ausgangskreis
- Hilfsenergie: 24 V DC \pm 15%, $P_V = \text{max. } 1 \text{ VA}$
- Eingepprägter Gleichstrom: Live-zero, 4...20 mA
- Außenwiderstand: max. 300 Ω
- Strombegrenzung bei Überlast: < 30 mA
- Restwelligkeit: $\leq 1\%$ p.p.
- Einstellzeit: < 300 ms

Anschlussschema des KBR 32/44 (4...20 mA):

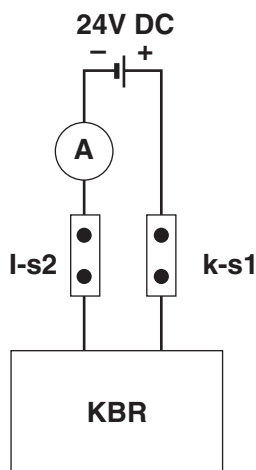



KBU 23

Kabelumbau-Stromwandler



Schiene 1	20 x 30 mm
Rundleiter	20 mm
Baubreite	93 mm
Bauhöhe	106 mm
Bautiefe gesamt	58 mm

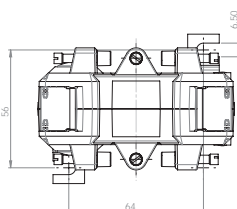
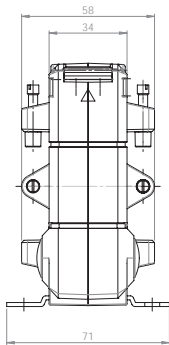
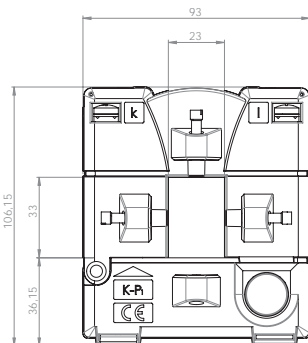

Primärstrom [A]	Bürde [VA]	Sekundärstrom [A] / Klasse		
		1 A Kl. 3 Best.-Nr.	1 A Kl. 1 Best.-Nr.	1 A Kl. 0,5 Best.-Nr.
100	1,25	80248		
150	1,5	80230		
200	2,5	80231		
250	1,5		80244	
300	3,75		80245	
400	1			80237
	5		80246	

Primärstrom [A]	Bürde [VA]	Sekundärstrom [A] / Klasse		
		5 A Kl. 3 Best.-Nr.	5 A Kl. 1 Best.-Nr.	5 A Kl. 0,5 Best.-Nr.
100	1,25	80048		
150	1,5	80030		
200	2,5	80031		
250	1,5		80044	
300	3,75		80045	
400	1			80037
	5		80046	



KBU 58

Kabelumbau-Stromwandler

Schiene 1	50 x 80 mm
Rundleiter	50 mm
Baubreite	125 mm
Bauhöhe	158 mm
Bautiefe gesamt	58 mm

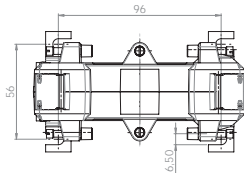
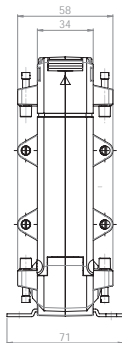
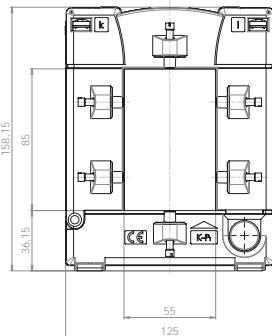

Primärstrom [A]	Bürde [VA]	Sekundärstrom [A] / Klasse			
		5 A Kl. 1 Best.-Nr.	5 A Kl. 0,5 Best.-Nr.	1 A Kl. 1 Best.-Nr.	1 A Kl. 0,5 Best.-Nr.
250	1,5	80061		80261	
300	2,5	80062		80262	
400	1		80038		80238
	2,5	80063		80263	
500	2,5		80054		80254
	5	80064		80264	
600	2,5		80055		80255
	5	80065		80265	
750	2,5		80056		80256
	5	80066		80266	
800	2,5		80057		80257
	7,5	80067		80267	
1000	5		80058		80258
	10	80068		80268	

ASR

ASG

AS / ASK

WSK

KBU

KSU / SUJK

NH

SASR / SASK

ASRD

ASKD / WSKD

CTB



KBU 812

Kabelumbau-Stromwandler



Schiene 1 80 x 120 mm
 Rundleiter 80 mm
 Baubreite 155 mm
 Bauhöhe 198 mm
 Bautiefe gesamt 58 mm

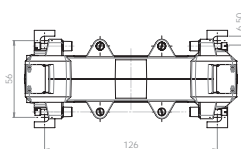
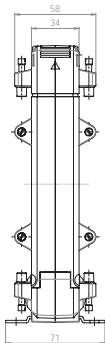
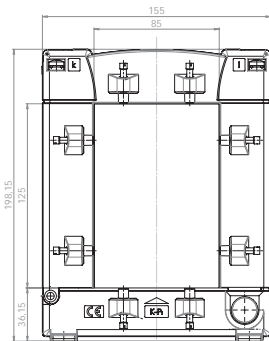

Primärstrom [A]	Bürde [VA]	Sekundärstrom [A] / Klasse			
		5 A Kl. 1 Best.-Nr.	5 A Kl. 0,5 Best.-Nr.	1 A Kl. 1 Best.-Nr.	1 A Kl. 0,5 Best.-Nr.
250	1,5	80091		80291	
300	2,5	80092		80292	
400	2,5	80093		80293	
500	2,5		80074		80274
	5	80094		80294	
600	2,5		80075		80275
	5	80095		80295	
750	2,5		80076		80276
	5	80096		80296	
800	2,5		80077		80277
	7,5	80097		80297	
1000	5		80078		80278
	10	80098		80298	
1200	5		80079		80279
	10	80099		80299	
1250	7,5		80080		80280
	15	80100		80300	
1500	7,5		80081		80281
	15	80101		80301	



KBU 816

Kabelumbau-Stromwandler

Schiene 1 80 x 160 mm
 Rundleiter 80 mm
 Baubreite 195 mm
 Bauhöhe 243 mm
 Bautiefe gesamt 79 mm

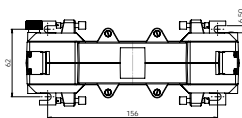
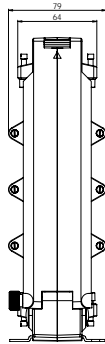
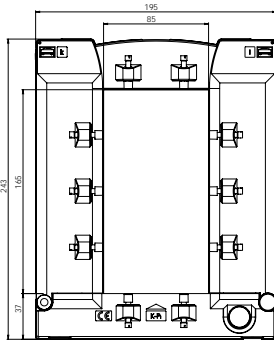

Primärstrom [A]	Bürde [VA]	Sekundärstrom [A] / Klasse			
		5 A Kl. 1 Best.-Nr.	5 A Kl. 0,5 Best.-Nr.	1 A Kl. 1 Best.-Nr.	1 A Kl. 0,5 Best.-Nr.
1000	10	80140	80110	80340	80310
	15	80141		80341	
1200	10	80142	80111	80342	80311
	15	80143		80343	
1500	10	80144	80112	80344	80312
	15	80145	80113	80345	80313
1600	10	80146	80114	80346	80314
	15	80147	80115	80347	80315
2000	10	80148	80116	80348	80316
	15	80149	80117	80349	80317
2500	10	80150	80119	80350	80319
	15	80151	80120	80351	80320
3000	15	80152	80122	80352	80322
	30	80153		80353	
4000	15	80154	80123	80354	80323
	30	80155	80124	80355	80324
5000	15	80156	80125	80356	80325
	30	80157	80126	80357	80326



Niederspannungs-Stromwandler für Industrie

Summen-Stromwandler

KSU

Summen-Stromwandler

Wandlerbreite

127 mm

Wandlertiefe

57 mm

SUSK

Summen-Stromwandler

Wandlerbreite

156 mm

Wandlertiefe

65 mm



Hinweise und Erläuterungen für die Bestellung von Summen-Stromwandlern

Summen-Stromwandler ermöglichen die Summierung mehrerer synchroner Wechselströme gleicher Phasenlage, jedoch unterschiedlicher Lastphasenverschiebungen. Es ist ebenfalls die Summierung von Strömen bei unterschiedlichen Nennspannungen gleicher Phasenlage möglich. Diese Messungen können jedoch nicht für Verrechnungszwecke genutzt werden, da die vorhandenen Spannungsdifferenzen voll als Fehler in die Messung eingehen.

Durch einen gegensinnigen Anschluss der Hauptwandler am Summen-Stromwandler ist es möglich, Sekundärströme zu erhalten, welche zur Differenz der primären Eingangsströme proportional sind.

Durch konstruktive Maßnahmen bei der Fertigung des Summen-Stromwandlers ist es möglich, Sekundärströme von Hauptwandlern unterschiedlicher Nennübersetzungsverhältnisse zu addieren.

Die Sekundäranschlüsse jedes Hauptwandlers werden an den zugeordneten Primäreingang des ihm zugeordneten Summen-Stromwandlers angeschlossen.

Die Windungszahlen jeder Teilwicklung des Primärkreises des Summen-Stromwandlers richten sich dabei nach dem Verhältnis des primären Nennstromes des entsprechenden Hauptwandlers zur Summe der Nennströme aller am Summen-Stromwandler angeschlossenen Hauptwandler.

Für die Anzeige des „Summenstromes“ kann ein Messgerät mit einem Messbereich gleich dem sekundären Nennstrom des Summen-Stromwandlers benutzt werden.

Bei anzuschließenden Hauptwandlern mit gleichem Nennübersetzungsverhältnis ist es belanglos, an welchem Primärkreis des Summen-Stromwandlers der Anschluss des Hauptwandlers erfolgt.

Bei Hauptwandlern mit unterschiedlichem Nennübersetzungsverhältnisse ist auf einen richtigen Anschluss desselben an dem ihm zugeordneten Eingang des Summen-Stromwandlers zu achten. Sollte im Hauptwandler kein Strom fließen, so darf der Sekundärkreis dieses Hauptwandlers weder am Summen-Stromwandler noch am Hauptwandler kurzgeschlossen werden.

Wenn ein Summen-Stromwandler einen noch nicht benutzten Primärkreis für den späteren Anschluss eines weiteren Hauptwandlers besitzt, so muss dieser Kreis offen bleiben. Der sekundäre Ausgangsstrom des Summen-Stromwandlers ist in diesem Falle um das Verhältnis des primären Nennstromes dieses „fehlenden“ Hauptwandlers zur Summe aller primären Nennströme der Hauptwandler kleiner als der sekundäre Nennstrom des Summen-Stromwandlers.

Der sekundäre Nennstrom eines Hauptwandlers muss gleich dem Primärenennstrom des ihm zugeordneten Einganges des Summen-Stromwandlers sein.



Hinweise und Erläuterungen für die Bestellung von Summen-Stromwandlern

Um dem Anwender die richtige Auswahl der Komponenten einer Messanordnung mit Summen-Stromwandler zu erleichtern, sei nachfolgendes Beispiel aufgeführt:

Beispiel:

Gegeben:	3 Übersetzungsverhältnisse	1000/5 A 800/5 A <u>600/5 A</u>
	Gesamtstrom	2400/5 A

Verbraucher:
– 1 Strommesser
– 1 Leistungsschreiber

Gesucht: 1 Summen-Stromwandler und die VA-Leistungen der einzelnen Hauptwandler

Erforderliche und aufzubringende Leistung des Summen-Stromwandlers:

Strommesser	1,5 VA
Leistungsschreiber	7,0 VA
Messleitungsverlust	1,5 VA
Eigenverbrauch P_0 Summenwandler	<u>4,0 VA</u>
Zwischenergebnis	14,0 VA

Von diesen 14,0 VA hat der einzelne Hauptwandler einen Leistungsanteil entsprechend seinem Verhältnis zur „Gesamtübersetzung“ aufzubringen.

Ferner ist der jeweilige Leitungsverlust zwischen Haupt- und Summenwandler zuzüglich eventueller sonstiger Verluste zu berücksichtigen.

1. Hauptwandler 1000/5A	$\frac{1000}{2400} \times 14,0 = 5,83 \text{ VA} + \text{zusätzlich eventueller Verluste}$
2. Hauptwandler 800/5A	$\frac{800}{2400} \times 14,0 = 4,67 \text{ VA} + \text{zusätzlich eventueller Verluste}$
3. Hauptwandler 600/5A	$\frac{600}{2400} \times 14,0 = 3,50 \text{ VA} + \text{zusätzlich eventueller Verluste}$

Die so ermittelten VA-Werte der Hauptwandler sind entsprechend den in unseren Listen enthaltenen VA-Werten aufzurunden.

Das Verhältnis des primären Nennstromes eines Hauptwandlers zur Summe der primären Nennströme aller Hauptwandler darf das Verhältnis von 1:8 nicht überschreiten.

Wichtiger Hinweis zur Leistungsbemessung

Zu große Abweichungen nach oben bewirken, dass der als Messwandler eingesetzte Stromwandler seine Schutzfunktion gegenüber den angeschlossenen Messgeräten nicht mehr erfüllen kann, da er bei Normalbetrieb weit unterhalb seiner Sättigungsgrenze arbeitet, bei auftretenden Überströmen jedoch viel später an die Sättigungsgrenze kommt und damit fast genau die Funktion eines Schutzwandlers übernimmt.

Andererseits wird bei zu großen Abweichungen nach unten der Messwandler infolge dauernder Überbeanspruchung vorzeitig zur Sättigungsgrenze kommen und damit indirekt als Schalter fungieren und eine Messung unmöglich machen.



KSU 2...3

Summen-Stromwandler



Baubreite 127 mm
 Bauhöhe 90 mm
 Bautiefe gesamt 57 mm

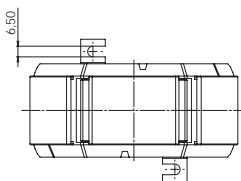
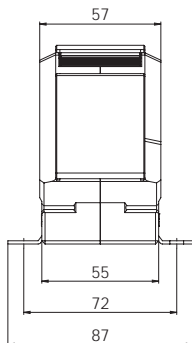
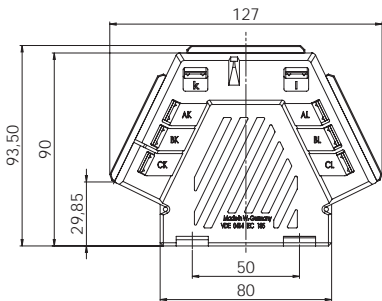

Ein-gänge	Primär-strom [A]	Sekundärstrom [A] / Klasse				
		Bürde [VA]	5 A Kl. 1 Best.-Nr.	5 A Kl. 0,5 Best.-Nr.	1 A Kl. 1 Best.-Nr.	1 A Kl. 0,5 Best.-Nr.
2	1	5	41114	41111	41314	41311
		10	41115	41112	41315	41312
		15	41116	41113	41316	41313
		20	41117		41317	
	5	25	41118		41318	
		5	41014	41011	41214	41211
		10	41015	41012	41215	41212
		15	41016	41013	41216	41213
3	1	20	41017		41217	
		5	41130	41127	41330	41327
		10	41131	41128	41331	41328
	5	15	41132	41129	41332	41329
		5	41030	41027	41230	41227
		10	41031	41028	41231	41228
		15	41032	41029	41232	41229

		Best.-Nr.
	Schnappbefestigung	-
	Plombierplatte Form B	59041

Anschlussbeispiel bei verschiedenen Übersetzungen:

- AK-AL = 1000/5
- BK-BL = 800/5
- CK-CL = 600/5

Anschlussbild

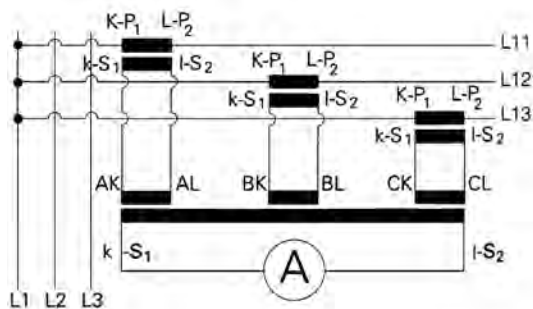



SUSK 3...8

Summen-Stromwandler

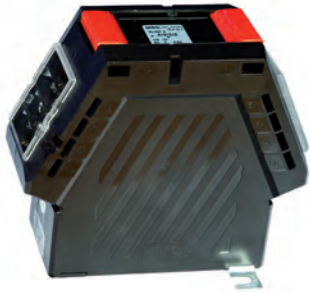

Baubreite 156 mm
 Bauhöhe 136,5 mm
 Bautiefe gesamt 65 mm

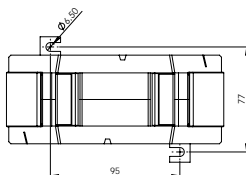
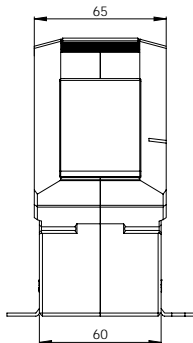
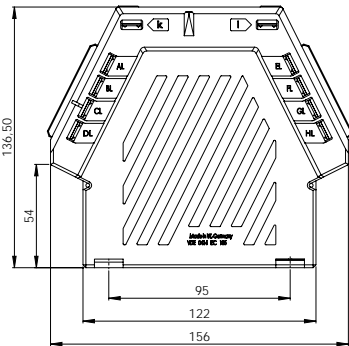

Ein-gänge	Primär-strom [A]	Sekundärstrom [A] / Klasse					
		Bürde [VA]	5 A Kl. 1 Best.-Nr.	5 A Kl. 0,5 Best.-Nr.	1 A Kl. 1 Best.-Nr.	1 A Kl. 0,5 Best.-Nr.	
3	1	5	40115	40111	40315	40311	
		10	40116	40112	40316	40312	
		15	40117	40114	40317	40314	
		30	40118		40318		
	5	5	40015	40011	40215	40211	
		10	40016	40012	40216	40212	
		15	40017	40014	40217	40214	
		30	40018		40218		
4	1	5	40126	40123	40326	40323	
		10	40127	40124	40327	40324	
		15	40128	40125	40328	40325	
		25	40129		40329		
	5	5	40026	40023	40226	40223	
		10	40027	40024	40227	40224	
		15	40028	40025	40228	40225	
		25	40029		40229		
	5	1	5	40137	40134	40337	40334
			10	40138	40135	40338	40335
			15	40139	40136	40339	40336
			30	40140		40340	
5		5	40037	40034	40237	40234	
		10	40038	40035	40238	40235	
		15	40039	40036	40239	40236	
		30	40040		40240		
6		1	5	40148	40145	40348	40345
			10	40149	40146	40349	40346
			15	40150	40147	40350	40347
			30	40151		40351	
	5	5	40048	40045	40248	40245	
		10	40049	40046	40249	40246	
		15	40050	40047	40250	40247	
		30	40051		40251		
7	1	5	40160	40157	40360	40357	
		10	40161	40158	40361	40358	
		15	40162	40159	40362	40359	
		30	40163		40363		
	5	5	40060	40057	40260	40257	
		10	40061	40058	40261	40258	
		15	40062	40059	40262	40259	
		30	40063		40263		
8	1	5	40171	40168	40371	40368	
		10	40172	40169	40372	40369	
		15	40173	40170	40373	40370	
		30	40174		40374		
	5	5	40071	40068	40271	40268	
		10	40072	40069	40272	40269	
		15	40073	40070	40273	40270	
		30	40074		40274		

ASR

ASG

AS / ASK

WSK

KBR / KBU

KSU / SJSK

NH

SASR / SASK

ASRD

ASKD / WSKD

CTB



MBS AG



		Best.-Nr.
	Schnappbefestigung	–
	Plombierplatte Form B	59041
	Plombierplatte Form C	59042

Anschlussbild

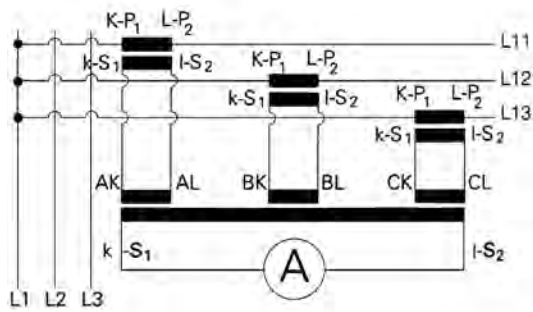

Niederspannungs-Stromwandler für Industrie

Sonder-Stromwandler

NH Stromwandler für Sicherungstrennleiste

NH-Stromwandler für Sicherungstrennleiste Größe 1, 2 und 3

Gehäusematerial: Technyl A20 V25 N025, 200 °C

Ausführung: Stromwandler zur direkten Montage in Verbindung mit Niederspannungs-Hochleistungssicherungen mit Kontaktmessern und NH-Sicherungseinsatz nach DIN 43620/1. NH-Stromwandler sind mit 2 bzw. 4 Steckbuchsen ausgestattet und können dauernd offen betrieben werden. Leerlaufspannung bei Sek. 5 A ca. 3 bis 6 V und bei Sek. 1 A ca. 13 bis 25 V. Die Stromwandler können auch sekundär 2-fach umschaltbar geliefert werden.





NH 6.1

Stromwandler für Sicherungstrennleisten



Schiene 1 24 x 6 mm
 Baubreite 52 mm
 Bauhöhe 68,5 mm
 Bautiefe gesamt 23 mm

Primärstrom [A]	Bürde [VA]	Sekundärstrom [A] / Klasse	
		5 A Kl. 3 Best.-Nr.	1 A Kl. 3 Best.-Nr.
100	1,25	50011	50211
150	2,5	50012	50212
200	3,5	50013	50213
250	4	50014	50214
300	5	50015	50215

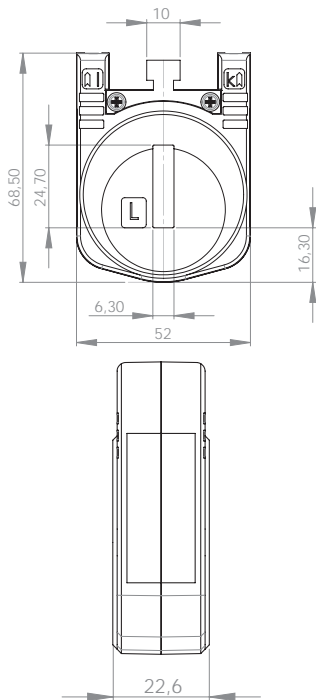

NH 6.1 2U

Stromwandler für Sicherungstrennleisten, sekundär umschaltbar

Primärstrom [A]	Bürde [VA]	Sekundärstrom [A] / Klasse	
		5 A Kl. 3 Best.-Nr.	1 A Kl. 3 Best.-Nr.
200-100	2,5-1,25	50111	50311
300-150	5-2,5	50112	50312

		Best.-Nr.
	Schnappbefestigung	-
	Plombierplatte	-

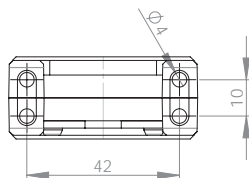

ASR

ASG

AS / ASK

WSK

KBR / KBU

KSU / SUJK

NH

SASR / SASK

ASRD

ASKD / WSKD

CTB



NH 6.2

Stromwandler für Sicherungstrennleisten

Schiene 1	30 x 6 mm
Baubreite	60 mm
Bauhöhe	74,5 mm
Bautiefe gesamt	24 mm

Primärstrom [A]	Bürde [VA]	Sekundärstrom [A] / Klasse	
		5 A Kl. 3 Best.-Nr.	1 A Kl. 3 Best.-Nr.
100	1,25	50021	50221
150	2,5	50022	50222
200	3,5	50023	50223
250	4	50024	50224
300	5	50025	50225
400	5	50026	50226

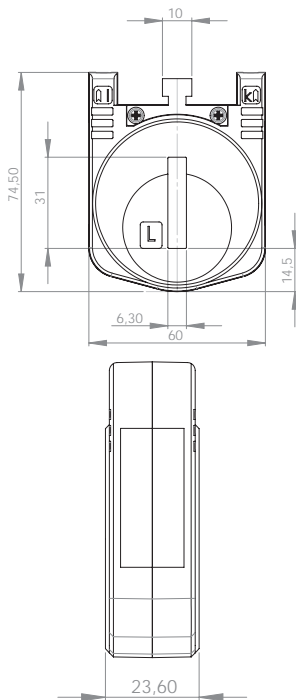

NH 6.2 2U

Stromwandler für Sicherungstrennleisten, sekundär umschaltbar

Primärstrom [A]	Bürde [VA]	Sekundärstrom [A] / Klasse	
		5 A Kl. 3 Best.-Nr.	1 A Kl. 3 Best.-Nr.
200-100	2,5-1,25	50121	50321
300-150	5-2,5	50122	50322
400-200	5-2,5	50123	50323

		Best.-Nr.
	Schnappbefestigung	–
	Plombierplatte	–

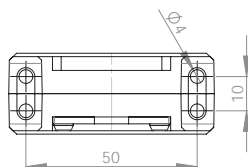



NH 6.3

Stromwandler für Sicherungstrennleisten



Schiene 1 32 x 6 mm
 Baubreite 74 mm
 Bauhöhe 89 mm
 Bautiefe gesamt 24 mm

Primärstrom [A]	Bürde [VA]	Sekundärstrom [A] / Klasse	
		5 A Kl. 3 Best.-Nr.	1 A Kl. 3 Best.-Nr.
150	2,5	50031	50231
200	3,5	50032	50232
250	4	50033	50233
300	5	50034	50234
400	5	50035	50235
500	5	50036	50236
600	10	50037	50237

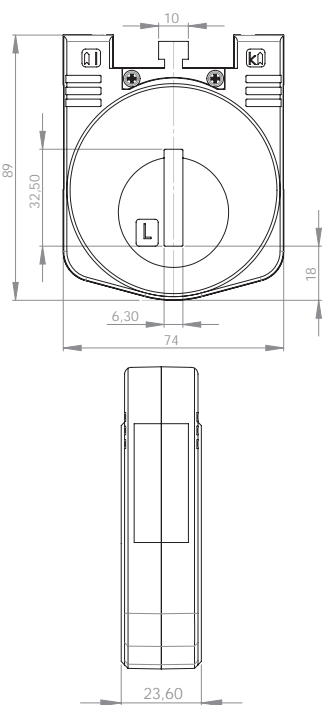

NH 6.3 2U

Stromwandler für Sicherungstrennleisten, sekundär umschaltbar

Primärstrom [A]	Bürde [VA]	Sekundärstrom [A] / Klasse	
		5 A Kl. 3 Best.-Nr.	1 A Kl. 3 Best.-Nr.
300-150	5-2,5	50131	50331
400-200	5-2,5	50132	50332
600-300	10-5	50133	50333

		Best.-Nr.
	Schnappbefestigung	-
	Plombierplatte	-

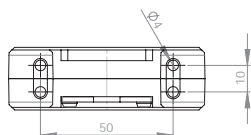

ASR
ASG
AS / ASK
WSK
KBR / KBU
KSU / SUJK
NH
SASR / SASK
ASRD
ASKD / WSKD
CTB



Niederspannungs-Stromwandler für Industrie

Schutz-Stromwandler

Schutz-Rohrstab-Stromwandler

SASR 22.3

Rundleiter
Wandlerbreite

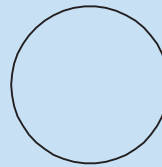

Ø 22,5 mm
61 mm

Schutz-Aufsteck-Stromwandler

SASK 21.3

Primärleiter
Rundleiter
Wandlerbreite

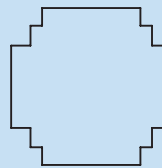

20 x 10 mm
Ø 19,2 mm
61 mm

SASK 31.5

Primärleiter
Rundleiter
Wandlerbreite

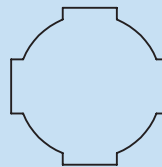

30 x 10 mm
2 x 20 x 10 mm
Ø 28 mm
61 mm

SASK 31.6

Primärleiter
Rundleiter
Wandlerbreite

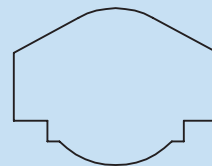

30 x 10 mm
20 x 13 mm
Ø 23 mm
95 mm



Schutz-Stromwandler – Technische Begriffe

Anwendung: Stromwandler dienen der galvanisch getrennten, proportionalen Umwandlung von Wechselströmen großer Stromstärken in kleinere, direkt messbare Werte. Entsprechend ihrer Verwendung erfolgt eine Unterscheidung in zwei Typen:

- Messwandler
- Schutzwandler

Alle durch MBS gefertigten Stromwandler sind für den Einsatz in Niederspannungsnetzen mit einer maximalen Leiter-Leiter-Spannung von 0,72 kV konzipiert.

Messwandler: Messwandler werden zur Messung von Strom, Leistung, Leistungsfaktor und Energieverbrauch unter direkter Verwendung eines entsprechenden Messgerätes verwendet. Durch die Dimensionierung ihres magnetischen Kreises ermöglichen Messwandler eine hohe Übertragungsgenauigkeit im Nennstrombereich, bei gleichzeitigem Schutz der angeschlossenen Geräte im Überstromfall. Dieser Schutz wird durch die im Überstromfall eintretende magnetische Sättigung des Messkernes verursacht.

Schutzwandler: Schutzstromwandler dienen der Ansteuerung von Schutzrelais, welche die Aufgabe haben, nachgeschaltete Schaltungen im Überstromfall zu trennen. Für eine sichere Funktion dieser Relais ist ein proportionales Übertragungsverhalten des Wandlers bis zu einem Vielfachen des Nennstromes erforderlich. Die Dimensionierung dieser Wandlerbauform stellt eine proportionale Stromübertragung bis zu einem von der Schutzklasse bestimmten Vielfachen des Nennstroms sicher.

Technische Normen: Alle MBS-Stromwandler werden in Übereinstimmung mit den technischen Forderungen der IEC 61869/1+2 (vormals IEC 60044-1) gefertigt.

Technische Merkmale: Einsatzort: Innenräume, ohne Betauung.

Schutz-Stromwandler:

- Umgebungstemperaturbereich: $-5^{\circ}\text{C} \dots +40^{\circ}\text{C}$.
- Gehäusematerial: Polykarbonat, selbstverlöschend
- Gehäusebauform: Halbschalengehäuse, ultraschallverschweißt
- Isolierstoffklasse: E
- Thermische Bemessungs-Dauerstromstärke: $1,2 \times I_N$
- Sekundäre Bemessungs-Stromstärken: 5 A bzw. 1 A
- Thermische Bemessungs-Kurzzeitstromstärke: $60 \times I_N$ (max. 100 kA)
- Max. Übertemperatur der Sekundärwicklung: 75 K
- Isolationsprüfspannung: 3 kV U_{eff} ; 50 Hz, 1 min

Sicherheitshinweis: Bedingt durch das physikalische Wirkprinzip können beim Betrieb des Stromwandlers mit offenem Sekundärkreis an dessen Anschlussklemmen für den Menschen gefährliche Spannungen auftreten. Besonders bei Schutz-Stromwandlern können dabei Spannungen von mehreren Kilovolt auftreten. Zur Vermeidung von Personen- bzw. Wandler Schäden ist ein solcher Betriebszustand untersagt!

Bestellhinweis: Zur korrekten Bearbeitung Ihrer Bestellung bitten wir um vollständige Übermittlung folgender Angaben:

Wandlertyp
Übersetzungsverhältnis
Genauigkeitsklasse
Bemessungsbürde

Genauigkeitsklassen von Stromwandlern														
Klasse	Stromfehler (\pm %) bei % I_N							Fehlwinkel (\pm Minuten) bei % I_N						Gesamtfehler bei $n \times I_N$
	1%	5%	20%	50%	100%	120%		1%	5%	20%	50%	100%	120%	
Messwandler														
0,2s	0,75	0,35	0,20	–	0,20	0,20		30	15	10	–	10	10	>10
0,2	–	0,75	0,35	–	0,20	0,20		–	30	15	–	10	10	>10
0,5s	1,50	0,75	0,50	–	0,50	0,50		90	45	30	–	30	30	>10
0,5	–	1,50	0,75	–	0,50	0,50		–	90	45	–	30	30	>10
1	–	3,00	1,50	–	1,00	1,00		–	180	90	–	60	60	>10
3	–	–	3,00	3,00	3,00	3,00		–	–	–	120	120	120	>10
Schutz-Stromwandler														
5P(n)	–	3,00	1,50	–	1,00	1,00		–	180	90	–	60	60	< 5
10P(n)	–	–	–	3,00	3,00	3,00		–	–	–	120	120	120	<10
n... Überstrombegrenzungsfaktor														



SASR 22.3

Schutz-Rohrstab-Stromwandler



Rundleiter 22,5 mm
 Baubreite 61 mm
 Bauhöhe 75,5 mm
 Bautiefe gesamt 35 mm

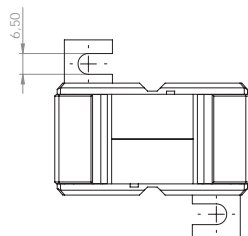
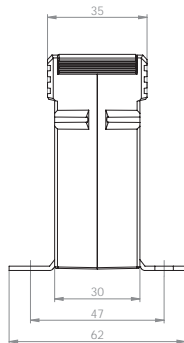
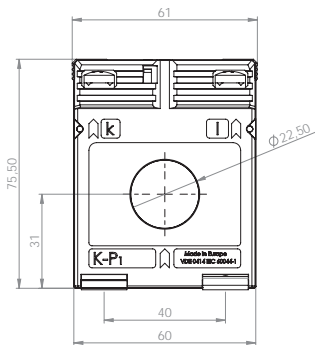

Primärstrom [A]	Bürde [VA]	Sekundärstrom [A] / Klasse			
		5 A Kl. 5P5 Best.-Nr.	5 A Kl. 10P5 Best.-Nr.	1 A Kl. 5P5 Best.-Nr.	1 A Kl. 10P5 Best.-Nr.
100	1			S04-1316B	S04-1317B
125	1	S04-1506B	S04-1507B		
	1,5			S04-1516C	S04-1517C
150	1	S04-1606B	S04-1607B		
	1,5			S04-1616C	S04-1617C
200	1	S04-1706B	S04-1707B		
	1,5			S04-1716C	S04-1717C
250	1	S04-1806B	S04-1807B		
	1,5			S04-1816C	S04-1817C
300	1	S04-1906B	S04-1907B		
	1,5		S04-1907C	S04-1916C	S04-1917C

		Best.-Nr.
	Schnappbefestigung Form A	53011
	Plombierplatte Form A	59040



MBS AG



SASK 21.3

Schutz-Aufsteck-Stromwandler



Schiene 1 20 x 10 mm
 Rundleiter 19,2 mm
 Baubreite 61 mm
 Bauhöhe 75,5 mm
 Bautiefe gesamt 48 mm

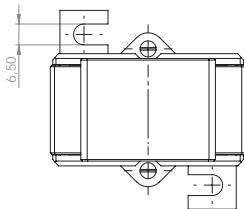
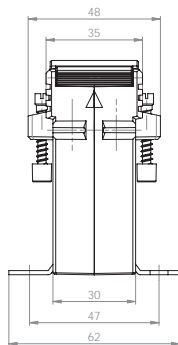
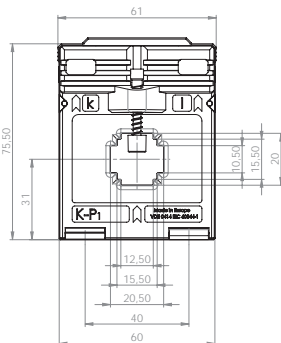

Primärstrom [A]	Bürde [VA]	Sekundärstrom [A] / Klasse			
		5 A Kl. 5P5 Best.-Nr.	5 A Kl. 10P5 Best.-Nr.	1 A Kl. 5P5 Best.-Nr.	1 A Kl. 10P5 Best.-Nr.
125	1	S03-1506B	S03-1507B		
	1,5			S03-1516C	S03-1517C
150	1	S03-1606B	S03-1607B		
	1,5			S03-1616C	S03-1617C
200	1	S03-1706B	S03-1707B		
	1,5			S03-1716C	S03-1717C

		Best.-Nr.
	Schnappbefestigung Form A	53011
	Plombierplatte Form A	59040



SASK 31.5

Schutz-Aufsteck-Stromwandler



- Schiene 1 30 x 10 mm
- Schiene 2 2 x 20 x 10 mm
- Rundleiter 28 mm
- Baubreite 61 mm
- Bauhöhe 75,5 mm
- Bautiefe gesamt 68 mm

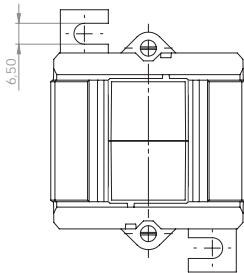
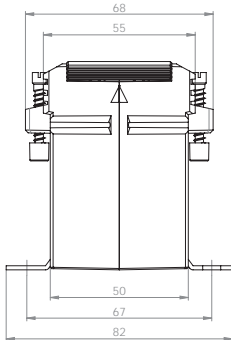
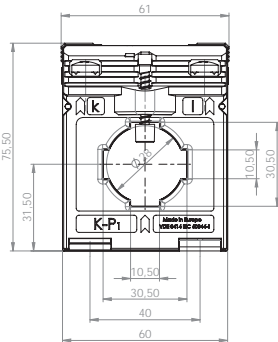

Primärstrom [A]	Bürde [VA]	Sekundärstrom [A] / Klasse			
		5 A Kl. 5P5 Best.-Nr.	5 A Kl. 10P5 Best.-Nr.	1 A Kl. 5P5 Best.-Nr.	1 A Kl. 10P5 Best.-Nr.
75	1			S17-1116B	S17-1117B
80	1			S17-1216B	S17-1217B
100	1	S17-1306B	S17-1307B		
	1,5			S17-1316C	S17-1317C
125	1	S17-1506B	S17-1507B		
	1,5		S17-1507C	S17-1516C	S17-1517C
150	1	S17-1606B	S17-1607B		
	1,5	S17-1606C	S17-1607C	S17-1616C	S17-1617C
200	1	S17-1706B	S17-1707B		
	1,5	S17-1706C	S17-1707C	S17-1716C	S17-1717C
	2,5	S17-1706D	S17-1707D	S17-1716D	S17-1717D
250	1,5	S17-1806C	S17-1807C	S17-1816C	S17-1817C
	2,5	S17-1806D	S17-1807D	S17-1816D	S17-1817D
300	1,5	S17-1906C	S17-1907C	S17-1916C	S17-1917C
	2,5	S17-1906D	S17-1907D	S17-1916D	S17-1917D
400	1,5	S17-2006C	S17-2007C	S17-2016C	S17-2017C
	2,5	S17-2006D	S17-2007D	S17-2016D	S17-2017D
500	1,5	S17-2106C	S17-2107C	S17-2116C	S17-2117C
	2,5	S17-2106D	S17-2107D	S17-2116D	S17-2117D
600	1,5	S17-2206C	S17-2207C	S17-2216C	S17-2217C
	2,5	S17-2206D	S17-2207D	S17-2216D	S17-2217D
750	1,5	S17-2306C	S17-2307C	S17-2316C	S17-2317C
	2,5	S17-2306D	S17-2307D	S17-2316D	S17-2317D

		Best.-Nr.
	Schnappbefestigung Form C	55011
	Plombierplatte Form B	59041

ASR

ASG

AS / ASK

WSK

KBR / KBU

KSU / SUJK

NH

SASK

ASRD

ASKD / WSKD

CTB



SASK 31.6

Schutz-Aufsteck-Stromwandler



Schiene 1	30 x 10 mm
Schiene 2	20 x 13 mm
Rundleiter	23 mm
Baubreite	95 mm
Bauhöhe	116 mm
Bautiefe gesamt	74 mm

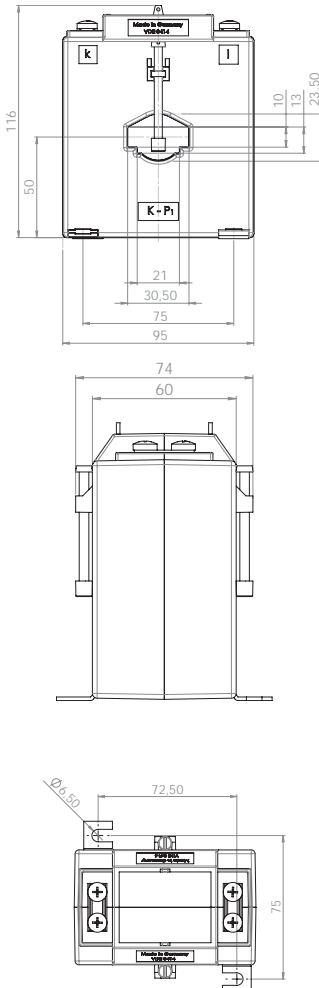

Primärstrom [A]	Bürde [VA]	Sekundärstrom [A] / Klasse		
		5 A Kl. 5P5 Best.-Nr.	5 A Kl. 10P5 Best.-Nr.	5 A Kl. 5P10 Best.-Nr.
50	1,5	S19-0906C	S19-0907C	
	2,5	S19-0906D	S19-0907D	
60	1,5	S19-1006C	S19-1007C	
	2,5	S19-1006D	S19-1007D	
80	1,5			S19-1208C
	2,5	S19-1206D	S19-1207D	
	5	S19-1206F	S19-1207F	
100	1,5	S19-1306C	S19-1307C	S19-1308C
	2,5	S19-1306D	S19-1307D	S19-1308D
	5	S19-1306F	S19-1307F	
150	2,5	S19-1606D	S19-1607D	S19-1608D
	5	S19-1606F	S19-1607F	S19-1608F
	7,5	S19-1606G	S19-1607G	
200	2,5	S19-1706D	S19-1707D	S19-1708D
	5	S19-1706F	S19-1707F	S19-1708F
	7,5	S19-1706G	S19-1707G	
	10	S19-1706H	S19-1707H	
250	2,5	S19-1806D	S19-1807D	S19-1808D
	5	S19-1806F	S19-1807F	S19-1808F
	7,5	S19-1806G	S19-1807G	
300	10	S19-1806H	S19-1807H	
	2,5	S19-1906D	S19-1907D	S19-1908D
	5	S19-1906F	S19-1907F	S19-1908F
400	10	S19-1906H	S19-1907H	
	2,5	S19-2006D	S19-2007D	S19-2008D
	5	S19-2006F	S19-2007F	S19-2008F
	7,5	S19-2006G	S19-2007G	S19-2008G
	10	S19-2006H	S19-2007H	S19-2008H
500	15	S19-2006J	S19-2007J	
	2,5	S19-2106D	S19-2107D	S19-2108D
	5	S19-2106F	S19-2107F	S19-2108F
	7,5	S19-2106G	S19-2107G	S19-2108G
	10	S19-2106H	S19-2107H	S19-2108H
600	15	S19-2106J	S19-2107J	
	2,5	S19-2206D	S19-2207D	S19-2208D
	5	S19-2206F	S19-2207F	S19-2208F
	7,5	S19-2206G	S19-2207G	S19-2208G
	10	S19-2206H	S19-2207H	S19-2208H
750	15	S19-2206J	S19-2207J	
	2,5	S19-2306D	S19-2307D	S19-2308D
	5	S19-2306F	S19-2307F	S19-2308F
	7,5	S19-2306G	S19-2307G	S19-2308G
750	10	S19-2306H	S19-2307H	S19-2308H
	15	S19-2306J	S19-2307J	



SASK 31.6

Schutz-Aufsteck-Stromwandler



Schiene 1	30 x 10 mm
Schiene 2	20 x 13 mm
Rundleiter	23 mm
Baubreite	95 mm
Bauhöhe	116 mm
Bautiefe gesamt	74 mm

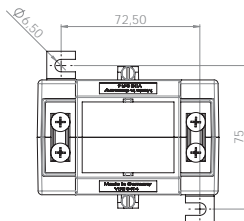
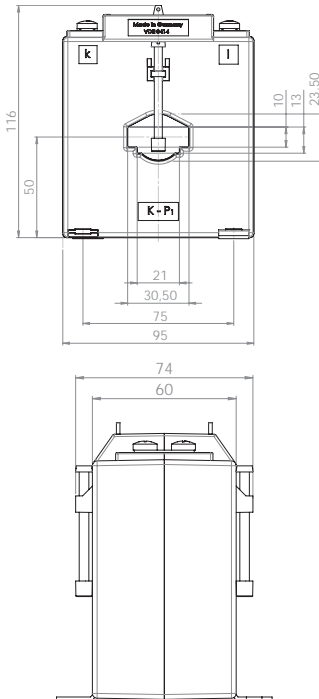

Primärstrom [A]	Bürde [VA]	Sekundärstrom [A] / Klasse		
		5 A Kl. 10P10 Best.-Nr.	5 A Kl. 5P15 Best.-Nr.	5 A Kl. 10P15 Best.-Nr.
60	1,5	S19-1009C		
80	1,5	S19-1209C		
100	1,5	S19-1309C	S19-130AC	S19-130BC
	2,5	S19-1309D		
150	2,5	S19-1609D	S19-160AD	S19-160BD
	5	S19-1609F		
200	2,5	S19-1709D	S19-170AD	S19-170BD
	5	S19-1709F		
250	2,5	S19-1809D	S19-180AD	S19-180BD
	5	S19-1809F		
300	2,5	S19-1909D	S19-190AD	S19-190BD
	5	S19-1909F		
400	2,5	S19-2009D	S19-200AD	S19-200BD
	5	S19-2009F	S19-200AF	S19-200BF
	7,5	S19-2009G		
	10	S19-2009H		
500	2,5	S19-2109D	S19-210AD	S19-210BD
	5	S19-2109F	S19-210AF	S19-210BF
	7,5	S19-2109G		
600	10	S19-2109H		
	2,5	S19-2209D	S19-220AD	S19-220BD
	5	S19-2209F	S19-220AF	S19-220BF
750	7,5	S19-2209G		
	10	S19-2209H		
	2,5	S19-2309D	S19-230AD	S19-230BD
750	5	S19-2309F	S19-230AF	S19-230BF
	7,5	S19-2309G		
	10	S19-2309H		

		Best.-Nr.
	Schnappbefestigung	-
	Plombierplatte Form E	59044



SASK 31.6

Schutz-Aufsteck-Stromwandler



Schiene 1	30 x 10 mm
Schiene 2	20 x 13 mm
Rundleiter	23 mm
Baubreite	95 mm
Bauhöhe	116 mm
Bautiefe gesamt	74 mm

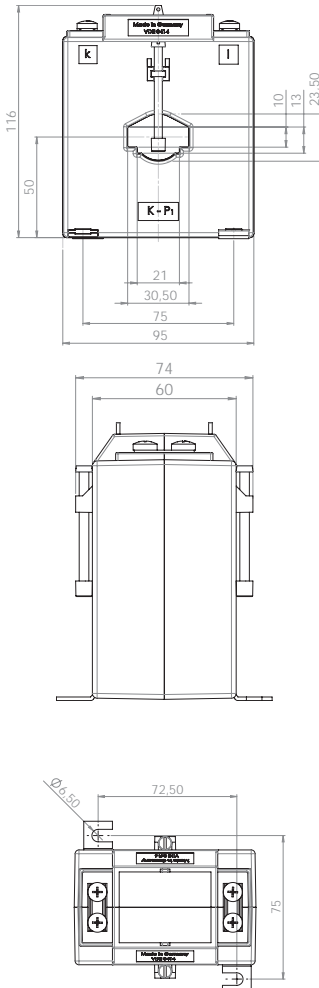

Primärstrom [A]	Bürde [VA]	Sekundärstrom [A] / Klasse		
		1 A Kl. 5P5 Best.-Nr.	1 A Kl. 10P5 Best.-Nr.	1 A Kl. 5P10 Best.-Nr.
50	1,5	S19-0916C	S19-0917C	
	2,5	S19-0916D	S19-0917D	
60	1,5	S19-1016C	S19-1017C	S19-1018C
	2,5	S19-1016D	S19-1017D	
80	1,5	S19-1216C	S19-1217C	S19-1218C
	2,5	S19-1216D	S19-1217D	S19-1218D
	5		S19-1217F	
100	2,5	S19-1316D	S19-1317D	S19-1318D
	5	S19-1316F	S19-1317F	
150	2,5	S19-1616D	S19-1617D	S19-1618D
	5	S19-1616F	S19-1617F	S19-1618F
200	2,5	S19-1716D	S19-1717D	S19-1718D
	5	S19-1716F	S19-1717F	S19-1718F
	7,5	S19-1716G	S19-1717G	
	10	S19-1716H	S19-1717H	
250	2,5	S19-1816D	S19-1817D	S19-1818D
	5	S19-1816F	S19-1817F	S19-1818F
	7,5	S19-1816G	S19-1817G	
300	2,5	S19-1916D	S19-1917D	S19-1918D
	5	S19-1916F	S19-1917F	S19-1918F
	10	S19-1916H	S19-1917H	
400	2,5	S19-2016D	S19-2017D	S19-2018D
	5	S19-2016F	S19-2017F	S19-2018F
	7,5	S19-2016G	S19-2017G	S19-2018G
	10	S19-2016H	S19-2017H	S19-2018H
500	15	S19-2016J	S19-2017J	
	2,5	S19-2116D	S19-2117D	S19-2118D
	5	S19-2116F	S19-2117F	S19-2118F
	7,5	S19-2116G	S19-2117G	S19-2118G
600	10	S19-2116H	S19-2117H	S19-2118H
	15	S19-2116J	S19-2117J	
	2,5	S19-2216D	S19-2217D	S19-2218D
	5	S19-2216F	S19-2217F	S19-2218F
750	7,5	S19-2216G	S19-2217G	S19-2218G
	10	S19-2216H	S19-2217H	S19-2218H
	15	S19-2216J	S19-2217J	
	2,5	S19-2316D	S19-2317D	S19-2318D
750	5	S19-2316F	S19-2317F	S19-2318F
	7,5	S19-2316G	S19-2317G	S19-2318G
	10	S19-2316H	S19-2317H	S19-2318H
	15	S19-2316J	S19-2317J	



SASK 31.6

Schutz-Aufsteck-Stromwandler



- Schiene 1 30 x 10 mm
- Schiene 2 20 x 13 mm
- Rundleiter 23 mm
- Baubreite 95 mm
- Bauhöhe 116 mm
- Bautiefe gesamt 74 mm

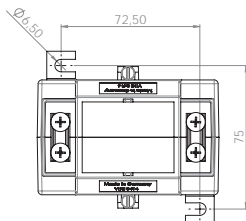
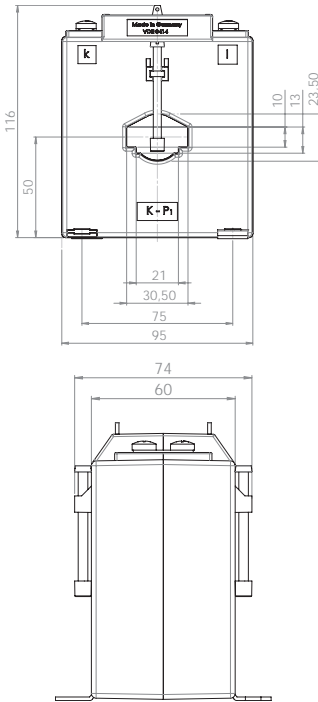

Primärstrom [A]	Bürde [VA]	Sekundärstrom [A] / Klasse		
		1 A Kl. 10P10 Best.-Nr.	1 A Kl. 5P15 Best.-Nr.	1 A Kl. 10P15 Best.-Nr.
60	1,5	S19-1019C		
80	1,5	S19-1219C		
	2,5	S19-1219D		
100	1,5		S19-131AC	S19-131BC
	2,5	S19-1319D		
150	2,5	S19-1619D	S19-161AD	S19-161BD
	5	S19-1619F		
200	2,5	S19-1719D	S19-171AD	S19-171BD
	5	S19-1719F		
250	2,5	S19-1819D	S19-181AD	S19-181BD
	5	S19-1819F		
300	2,5	S19-1919D	S19-191AD	S19-191BD
	5	S19-1919F		
400	2,5	S19-2019D	S19-201AD	S19-201BD
	5	S19-2019F	S19-201AF	S19-201BF
	7,5	S19-2019G		
	10	S19-2019H		
500	2,5	S19-2119D	S19-211AD	S19-211BD
	5	S19-2119F	S19-211AF	S19-211BF
	7,5	S19-2119G		
600	10	S19-2119H		
	2,5	S19-2219D	S19-221AD	S19-221BD
	5	S19-2219F	S19-221AF	S19-221BF
750	7,5	S19-2219G		
	10	S19-2219H		
	2,5	S19-2319D	S19-231AD	S19-231BD
750	5	S19-2319F	S19-231AF	S19-231BF
	7,5	S19-2319G		
	10	S19-2319H		

		Best.-Nr.
	Schnappbefestigung	-
	Plombierplatte Form E	59044

ASR

ASG

AS / ASK

WSK

KBR / KBU

KSU / SUJK

NH

SASK

ASRD

ASKD / WSKD

CTB



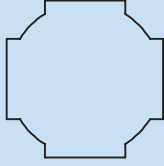
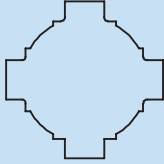
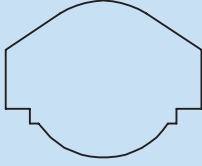
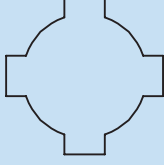

Schutz-Aufsteck-Stromwandler

SASK 421.4	Primärleiter Rundleiter Wandlerbreite		20 x 10 mm Ø 20 mm 71 mm
SASK 41.4	Primärleiter Rundleiter Wandlerbreite		40 x 10 mm 2 x 30 x 5 mm Ø 32 mm 71 mm
SASK 41.6	Primärleiter Rundleiter Wandlerbreite		40 x 12 mm 30 x 5 mm Ø 32 mm 95 mm
SASK 41.10	Primärleiter Rundleiter Wandlerbreite		40 x 10 mm Ø 32 mm 150 mm



SASK 421.4

Schutz-Aufsteck-Stromwandler



Schiene 1	20 x 10 mm
Rundleiter	20 mm
Baubreite	71 mm
Bauhöhe	85,5 mm
Bautiefe gesamt	58 mm

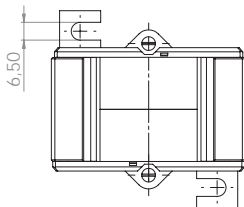
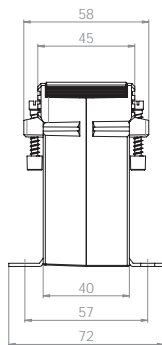
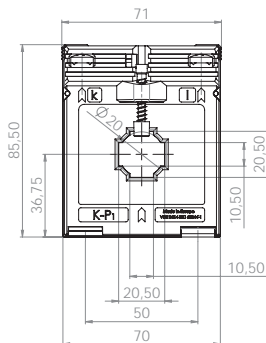

Primärstrom [A]	Bürde [VA]	Sekundärstrom [A] / Klasse			
		5 A Kl. 5P5 Best.-Nr.	5 A Kl. 10P5 Best.-Nr.	1 A Kl. 5P5 Best.-Nr.	1 A Kl. 10P5 Best.-Nr.
100	2,5	S23-1306D	S23-1307D	S23-1316D	S23-1317D
150	2,5	S23-1606D	S23-1607D	S23-1616D	S23-1617D
200	1,5	S23-1706C	S23-1707C	S23-1716C	S23-1717C
	2,5	S23-1706D	S23-1707D	S23-1716D	S23-1717D
250	1,5	S23-1806C	S23-1807C	S23-1816C	S23-1817C
	2,5	S23-1806D	S23-1807D	S23-1816D	S23-1817D
300	1,5	S23-1906C	S23-1907C	S23-1916C	S23-1917C
	2,5	S23-1906D	S23-1907D	S23-1916D	S23-1917D
400	1,5	S23-2006C	S23-2007C	S23-2016C	S23-2017C
	2,5	S23-2006D	S23-2007D	S23-2016D	S23-2017D

		Best.-Nr.
	Schnappbefestigung	–
	Plombierplatte Form B	59041



SASK 41.4

Schutz-Aufsteck-Stromwandler



Schiene 1	40 x 10 mm
Schiene 2	2 x 30 x 5 mm
Rundleiter	32 mm
Baubreite	71 mm
Bauhöhe	85,5 mm
Bautiefe gesamt	58 mm

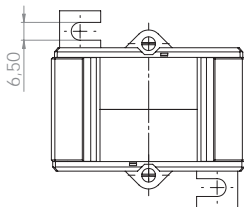
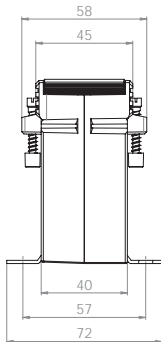
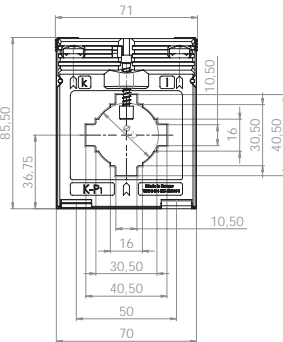

Primärstrom [A]	Bürde [VA]	Sekundärstrom [A] / Klasse			
		5 A Kl. 5P5 Best.-Nr.	5 A Kl. 10P5 Best.-Nr.	1 A Kl. 5P5 Best.-Nr.	1 A Kl. 10P5 Best.-Nr.
100	1	S24-1306B	S24-1307B	S24-1316B	S24-1317B
120	1	S24-1406B	S24-1407B	S24-1416B	S24-1417B
125	1	S24-1506B	S24-1507B	S24-1516B	S24-1517B
150	1	S24-1606B	S24-1607B		
	1,5		S24-1607C	S24-1616C	S24-1617C
200	1,5	S24-1706C	S24-1707C	S24-1716C	S24-1717C
250	1,5	S24-1806C	S24-1807C	S24-1816C	S24-1817C
	2,5		S24-1807D	S24-1816D	S24-1817D
300	1,5	S24-1906C	S24-1907C	S24-1916C	S24-1917C
	2,5	S24-1906D	S24-1907D	S24-1916D	S24-1917D
400	1,5	S24-2006C	S24-2007C	S24-2016C	S24-2017C
	2,5	S24-2006D	S24-2007D	S24-2016D	S24-2017D
500	1,5	S24-2106C	S24-2107C	S24-2116C	S24-2117C
	2,5			S24-2116D	S24-2117D
600	1,5	S24-2206C	S24-2207C	S24-2216C	S24-2217C
	2,5			S24-2216D	S24-2217D
750	1,5	S24-2306C	S24-2307C	S24-2316C	S24-2317C
	2,5		S24-2307D	S24-2316D	S24-2317D

		Best.-Nr.
	Schnappbefestigung Form D	55012
	Plombierplatte Form B	59041



MBS AG



SASK 41.6

Schutz-Aufsteck-Stromwandler



Schiene 1	40 x 12 mm
Schiene 2	30 x 15 mm
Rundleiter	32 mm
Baubreite	95 mm
Bauhöhe	116 mm
Bautiefe gesamt	74 mm

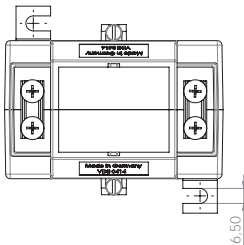
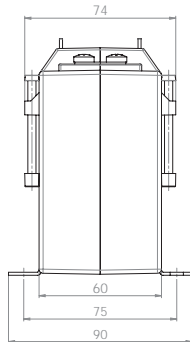
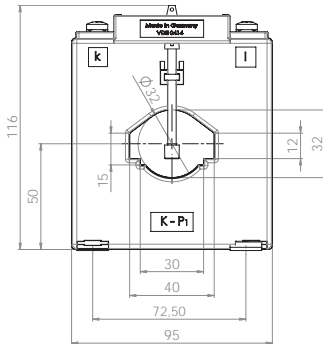

Primärstrom [A]	Bürde [VA]	Sekundärstrom [A] / Klasse			
		5 A Kl. 5P5 Best.-Nr.	5 A Kl. 10P5 Best.-Nr.	5 A Kl. 5P10 Best.-Nr.	5 A Kl. 10P10 Best.-Nr.
75	1,5	S30-1106C	S30-1107C	S30-1108C	S30-1109C
	2,5	S30-1106D	S30-1107D		
100	1,5	S30-1306C	S30-1307C	S30-1308C	S30-1309C
	2,5	S30-1306D	S30-1307D	S30-1308D	S30-1309D
	5	S30-1306F	S30-1307F		
150	2,5	S30-1606D	S30-1607D	S30-1608D	S30-1609D
	5	S30-1606F	S30-1607F		
200	2,5	S30-1706D	S30-1707D	S30-1708D	S30-1709D
	5	S30-1706F	S30-1707F		S30-1709F
	7,5	S30-1706G	S30-1707G		
	10	S30-1706H	S30-1707H		
250	2,5	S30-1806D	S30-1807D	S30-1808D	S30-1809D
	5	S30-1806F	S30-1807F	S30-1808F	S30-1809F
	7,5	S30-1806G	S30-1807G		
	10	S30-1806H	S30-1807H		
300	2,5	S30-1906D	S30-1907D	S30-1908D	S30-1909D
	5	S30-1906F	S30-1907F	S30-1908F	S30-1909F
	7,5	S30-1906G	S30-1907G		
	10	S30-1906H	S30-1907H		
	15		S30-1906J		
400	2,5	S30-2006D	S30-2007D	S30-2008D	S30-2009D
	5	S30-2006F	S30-2007F	S30-2008F	S30-2009F
	7,5	S30-2006G	S30-2007G	S30-2008G	S30-2009G
	10	S30-2006H	S30-2007H		
	15	S30-2006J	S30-2007J		
500	2,5	S30-2106D	S30-2107D	S30-2108D	S30-2109D
	5	S30-2106F	S30-2107F	S30-2108F	S30-2109F
	7,5	S30-2106G	S30-2107G	S30-2108G	S30-2109G
	10	S30-2106H	S30-2107H	S30-2108H	S30-2109H
	15	S30-2106J	S30-2107J		
600	2,5	S30-2206D	S30-2207D	S30-2208D	S30-2209D
	5	S30-2206F	S30-2207F	S30-2208F	S30-2209F
	7,5	S30-2206G	S30-2207G	S30-2208G	S30-2209G
	10	S30-2206H	S30-2207H	S30-2208H	S30-2209H
	15	S30-2206J	S30-2207J		
750	2,5	S30-2306D	S30-2307D	S30-2308D	S30-2309D
	5	S30-2306F	S30-2307F	S30-2308F	S30-2309F
	7,5	S30-2306G	S30-2307G	S30-2308G	S30-2309G
	10	S30-2306H	S30-2307H	S30-2308H	S30-2309H
	15	S30-2306J	S30-2307J		

		Best.-Nr.
	Schnappbefestigung	–
	Plombierplatte Form E	59044



SASK 41.6

Schutz-Aufsteck-Stromwandler



Schiene 1	40 x 12 mm
Schiene 2	30 x 15 mm
Rundleiter	32 mm
Baubreite	95 mm
Bauhöhe	116 mm
Bautiefe gesamt	74 mm

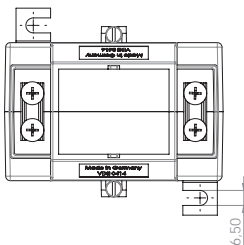
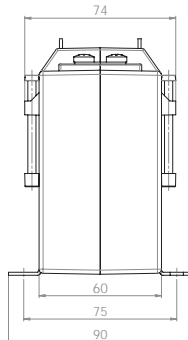
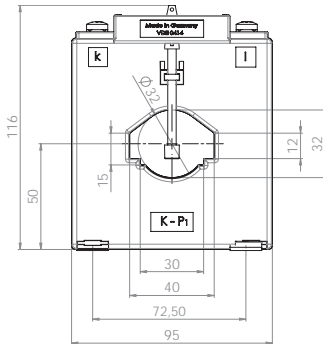

Primärstrom [A]	Bürde [VA]	Sekundärstrom [A] / Klasse			
		1 A Kl. 5P5 Best.-Nr.	1 A Kl. 10P5 Best.-Nr.	1 A Kl. 5P10 Best.-Nr.	1 A Kl. 10P10 Best.-Nr.
75	1,5	S30-1116C	S30-1117C	S30-1118C	S30-1119C
	2,5	S30-1116D	S30-1117D		
100	1,5	S30-1316C	S30-1317C	S30-1318C	S30-1319C
	2,5	S30-1316D	S30-1317D	S30-1318D	S30-1319D
	5	S30-1316F	S30-1317F		
150	2,5	S30-1616D	S30-1617D	S30-1618D	S30-1619D
	5	S30-1616F	S30-1617F		
	7,5		S30-1617G		
200	2,5	S30-1716D		S30-1718D	S30-1719D
	5	S30-1716F	S30-1717F		S30-1719F
	7,5	S30-1716G	S30-1717G		
	10	S30-1716H	S30-1717H		
250	2,5	S30-1816D	S30-1817D	S30-1818D	S30-1819D
	5	S30-1816F	S30-1817F	S30-1818F	S30-1819F
	7,5	S30-1816G	S30-1817G		
	10	S30-1816H	S30-1817H		
300	2,5	S30-1916D	S30-1917D	S30-1918D	S30-1919D
	5	S30-1916F	S30-1917F	S30-1918F	S30-1919F
	7,5	S30-1916G	S30-1917G		
	10	S30-1916H	S30-1917H		
	15		S30-1916J		
400	2,5	S30-2016D	S30-2017D	S30-2018D	S30-2019D
	5	S30-2016F	S30-2017F	S30-2018F	S30-2019F
	7,5	S30-2016G	S30-2017G	S30-2018G	S30-2019G
	10	S30-2016H	S30-2017H		
	15	S30-2016J	S30-2017J		
500	2,5	S30-2116D	S30-2117D	S30-2118D	S30-2119D
	5	S30-2116F	S30-2117F	S30-2118F	S30-2119F
	7,5	S30-2116G	S30-2117G	S30-2118G	S30-2119G
	10	S30-2116H	S30-2117H	S30-2118H	S30-2119H
	15	S30-2116J	S30-2117J		
600	2,5	S30-2216D	S30-2217D	S30-2218D	S30-2219D
	5	S30-2216F	S30-2217F	S30-2218F	S30-2219F
	7,5	S30-2216G	S30-2217G	S30-2218G	S30-2219G
	10	S30-2216H	S30-2217H	S30-2218H	S30-2219H
	15	S30-2216J	S30-2217J		
750	2,5	S30-2316D	S30-2317D	S30-2318D	S30-2319D
	5	S30-2316F	S30-2317F	S30-2318F	S30-2319F
	7,5	S30-2316G	S30-2317G	S30-2318G	S30-2319G
	10	S30-2316H	S30-2317H	S30-2318H	S30-2319H
	15	S30-2316J	S30-2317J		

		Best.-Nr.
	Schnappbefestigung	-
	Plombierplatte Form E	59044



SASK 41.10

Schutz-Aufsteck-Stromwandler



Schiene 1 40 x 10 mm
 Rundleiter 32 mm
 Baubreite 150 mm
 Bauhöhe 175,5 mm
 Bautiefe gesamt 114 mm

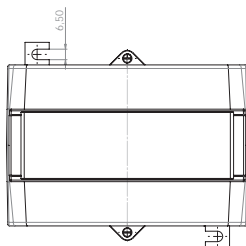
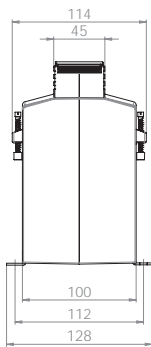
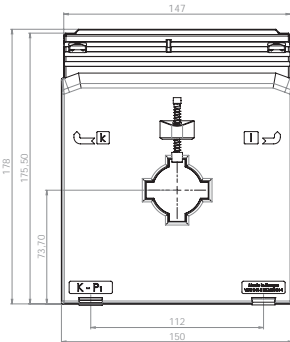

Primärstrom [A]	Bürde [VA]	Sekundärstrom [A] / Klasse			
		5 A Kl. 5P5 Best.-Nr.	5 A Kl. 10P5 Best.-Nr.	5 A Kl. 5P10 Best.-Nr.	5 A Kl. 10P10 Best.-Nr.
75	2,5	S31-1106D	S31-1107D		
	5		S31-1107F		
100	5	S31-1306F	S31-1307F	S31-1308F	S31-1309F
	7,5	S31-1306G	S31-1307G		
	10		S31-1307H		
150	5	S31-1606F	S31-1607F	S31-1608F	S31-1609F
	7,5	S31-1606G	S31-1607G	S31-1608G	S31-1609G
	10	S31-1606H	S31-1607H		
	15	S31-1606J	S31-1607J		
200	5	S31-1706F	S31-1707F	S31-1708F	S31-1709F
	7,5	S31-1706G	S31-1707G	S31-1708G	S31-1709G
	10	S31-1706H	S31-1707H	S31-1708H	S31-1709H
	15	S31-1706J	S31-1707J		
250	5	S31-1806F	S31-1807F	S31-1808F	S31-1809F
	7,5	S31-1806G	S31-1807G	S31-1808G	S31-1809G
	10	S31-1806H	S31-1807H	S31-1808H	S31-1809H
	15	S31-1806J	S31-1807J		
300	5	S31-1906F	S31-1907F	S31-1908F	S31-1909F
	7,5	S31-1906G	S31-1907G	S31-1908G	S31-1909G
	10	S31-1906H	S31-1907H	S31-1908H	S31-1909H
	15	S31-1906J	S31-1907J	S31-1908J	S31-1909J
	30	S31-1906L	S31-1907L		
400	5	S31-2006F	S31-2007F	S31-2008F	S31-2009F
	7,5	S31-2006G	S31-2007G	S31-2008G	S31-2009G
	10	S31-2006H	S31-2007H	S31-2008H	S31-2009H
	15	S31-2006J	S31-2007J	S31-2008J	S31-2009J
	30	S31-2006L	S31-2007L		
500	5	S31-2106F	S31-2107F	S31-2108F	S31-2109F
	7,5	S31-2106G	S31-2107G	S31-2108G	S31-2109G
	10	S31-2106H	S31-2107H	S31-2108H	S31-2109H
	15	S31-2106J	S31-2107J	S31-2108J	S31-2109J
	30	S31-2106L	S31-2107L		
600	5	S31-2206F	S31-2207F	S31-2208F	S31-2209F
	7,5	S31-2206G	S31-2207G	S31-2208G	S31-2209G
	10	S31-2206H	S31-2207H	S31-2208H	S31-2209H
	15	S31-2206J	S31-2207J	S31-2208J	S31-2209J
	30	S31-2206L	S31-2207L		
750	5	S31-2306F	S31-2307F	S31-2308F	S31-2309F
	7,5	S31-2306G	S31-2307G	S31-2308G	S31-2309G
	10	S31-2306H	S31-2307H	S31-2308H	S31-2309H
	15	S31-2306J	S31-2307J	S31-2308J	S31-2309J
	30	S31-2306L	S31-2307L		
800	5	S31-2406F	S31-2407F	S31-2408F	S31-2409F
	7,5	S31-2406G	S31-2407G	S31-2408G	S31-2409G
	10	S31-2406H	S31-2407H	S31-2408H	S31-2409H
	15	S31-2406J	S31-2407J	S31-2408J	S31-2409J
	30	S31-2406L	S31-2407L		



SASK 41.10

Schutz-Aufsteck-Stromwandler



Schiene 1	40 x 10 mm
Rundleiter	32 mm
Baubreite	150 mm
Bauhöhe	175,5 mm
Bautiefe gesamt	114 mm

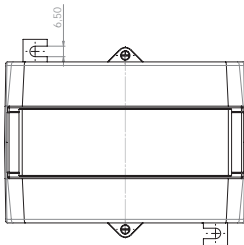
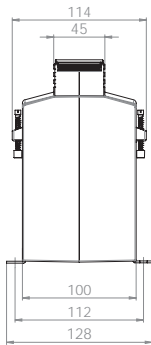
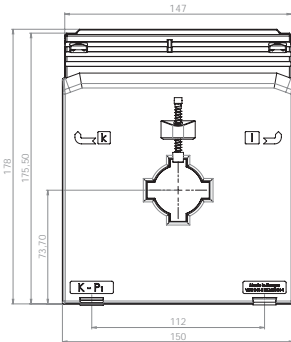

Primärstrom [A]	Bürde [VA]	Sekundärstrom [A] / Klasse			
		5 A Kl. 5P15 Best.-Nr.	5 A Kl. 10P15 Best.-Nr.	5 A Kl. 5P20 Best.-Nr.	5 A Kl. 10P20 Best.-Nr.
100	2,5	S31-130AD	S31-130BD		
150	2,5	S31-160AD	S31-160BD	S31-160CD	S31-160DD
	5	S31-160AF	S31-160BF		
200	5	S31-170AF	S31-170BF	S31-170CF	S31-170DF
250	5	S31-180AF	S31-180BF	S31-180CF	S31-180DF
300	5	S31-190AF	S31-190BF	S31-190CF	S31-190DF
	7,5	S31-190AG	S31-190BG		
	10	S31-190AH	S31-190BH		
400	5	S31-200AF	S31-200BF	S31-200CF	S31-200DF
	7,5	S31-200AG	S31-200BG	S31-200CG	S31-200DG
	10	S31-200AH	S31-200BH	S31-200CH	S31-200DH
500	5	S31-210AF	S31-210BF	S31-210CF	S31-210DF
	7,5	S31-210AG	S31-210BG	S31-210CG	S31-210DG
	10	S31-210AH	S31-210BH	S31-210CH	S31-210DH
	15	S31-210AJ	S31-210BJ		
600	5	S31-220AF	S31-220BF	S31-220CF	S31-220DF
	7,5	S31-220AG	S31-220BG	S31-220CG	S31-220DG
	10	S31-220AH	S31-220BH	S31-220CH	S31-220DH
	15	S31-220AJ	S31-220BJ		
750	5	S31-230AF	S31-230BF	S31-230CF	S31-230DF
	7,5	S31-230AG	S31-230BG	S31-230CG	S31-230DG
	10	S31-230AH	S31-230BH	S31-230CH	S31-230DH
	15	S31-230AJ	S31-230BJ		
800	5	S31-240AF	S31-240BF	S31-240CF	S31-240DF
	7,5	S31-240AG	S31-240BG	S31-240CG	S31-240DG
	10	S31-240AH	S31-240BH	S31-240CH	S31-240DH
	15	S31-240AJ	S31-240BJ		

		Best.-Nr.
	Schnappbefestigung	-
	Plombierplatte	-



SASK 41.10

Schutz-Aufsteck-Stromwandler



Schiene 1 40 x 10 mm
 Rundleiter 32 mm
 Baubreite 150 mm
 Bauhöhe 175,5 mm
 Bautiefe gesamt 114 mm

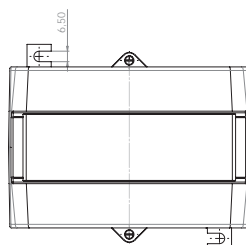
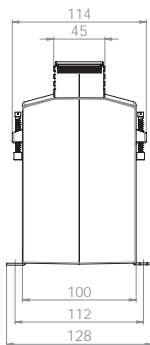
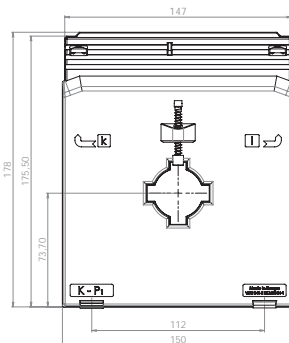

Primärstrom [A]	Bürde [VA]	Sekundärstrom [A] / Klasse			
		1 A Kl. 5P5 Best.-Nr.	1 A Kl. 10P5 Best.-Nr.	1 A Kl. 5P10 Best.-Nr.	1 A Kl. 10P10 Best.-Nr.
75	2,5	S31-1116D	S31-1117D		
	5		S31-1117F		
100	5	S31-1316F	S31-1317F	S31-1318F	S31-1319F
	7,5	S31-1316G	S31-1317G		
	10	S31-1316H	S31-1317H		
150	5	S31-1616F	S31-1617F	S31-1618F	S31-1619F
	7,5	S31-1616G	S31-1617G	S31-1618G	S31-1619G
	10	S31-1616H	S31-1617H		
200	15	S31-1616J	S31-1617J		
	5	S31-1716F	S31-1717F	S31-1718F	S31-1719F
	7,5	S31-1716G	S31-1717G	S31-1718G	S31-1719G
250	10	S31-1716H	S31-1717H	S31-1718H	S31-1719H
	15	S31-1716J	S31-1717J		
	5	S31-1816F	S31-1817F	S31-1818F	S31-1819F
300	7,5	S31-1816G	S31-1817G	S31-1818G	S31-1819G
	10	S31-1816H	S31-1817H	S31-1818H	S31-1819H
	15	S31-1816J	S31-1817J		
400	5	S31-1916F	S31-1917F	S31-1918F	S31-1919F
	7,5	S31-1916G	S31-1917G	S31-1918G	S31-1919G
	10	S31-1916H	S31-1917H	S31-1918H	S31-1919H
500	15	S31-1916J	S31-1917J	S31-1918J	S31-1919J
	30	S31-1916L	S31-1917L		
	5	S31-2016F	S31-2017F	S31-2018F	S31-2019F
600	7,5	S31-2016G	S31-2017G	S31-2018G	S31-2019G
	10	S31-2016H	S31-2017H	S31-2018H	S31-2019H
	15	S31-2016J	S31-2017J	S31-2018J	S31-2019J
750	30	S31-2016L	S31-2017L		
	5	S31-2116F	S31-2117F	S31-2118F	S31-2119F
	7,5	S31-2116G	S31-2117G	S31-2118G	S31-2119G
800	10	S31-2116H	S31-2117H	S31-2118H	S31-2119H
	15	S31-2116J	S31-2117J	S31-2118J	S31-2119J
	30	S31-2116L	S31-2117L		
800	5	S31-2216F	S31-2217F	S31-2218F	S31-2219F
	7,5	S31-2216G	S31-2217G	S31-2218G	S31-2219G
	10	S31-2216H	S31-2217H	S31-2218H	S31-2219H
800	15	S31-2216J	S31-2217J	S31-2218J	S31-2219J
	30	S31-2216L	S31-2217L		
	5	S31-2316F	S31-2317F	S31-2318F	S31-2319F
800	7,5	S31-2316G	S31-2317G	S31-2318G	S31-2319G
	10	S31-2316H	S31-2317H	S31-2318H	S31-2319H
	15	S31-2316J	S31-2317J	S31-2318J	S31-2319J
800	30	S31-2316L	S31-2317L		
	5	S31-2416F	S31-2417F	S31-2418F	S31-2419F
	7,5	S31-2416G	S31-2417G	S31-2418G	S31-2419G
800	10	S31-2416H	S31-2417H	S31-2418H	S31-2419H
	15	S31-2416J	S31-2417J	S31-2418J	S31-2419J
	30	S31-2416L	S31-2417L		



SASK 41.10

Schutz-Aufsteck-Stromwandler



- Schiene 1 40 x 10 mm
- Rundleiter 32 mm
- Baubreite 150 mm
- Bauhöhe 175,5 mm
- Bautiefe gesamt 114 mm

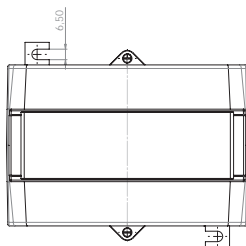
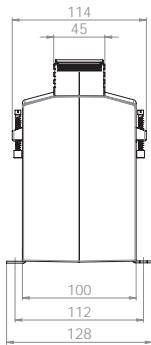
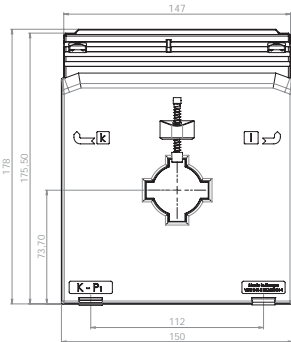

Primärstrom [A]	Bürde [VA]	Sekundärstrom [A] / Klasse			
		1 A Kl. 5P15 Best.-Nr.	1 A Kl. 10P15 Best.-Nr.	1 A Kl. 5P20 Best.-Nr.	1 A Kl. 10P20 Best.-Nr.
100	2,5	S31-131AD	S31-131BD		
150	2,5	S31-161AD	S31-161BD	S31-161CD	S31-161DD
	5	S31-161AF	S31-161BF		
200	5	S31-171AF	S31-171BF	S31-171CF	S31-171DF
250	5	S31-181AF	S31-181BF	S31-181CF	S31-181DF
300	5	S31-191AF	S31-191BF	S31-191CF	S31-191DF
	7,5	S31-191AG	S31-191BG		
	10	S31-191AH	S31-191BH		
400	5	S31-201AF	S31-201BF	S31-201CF	S31-201DF
	7,5	S31-201AG	S31-201BG	S31-201CG	S31-201DG
	10	S31-201AH	S31-201BH	S31-201CH	S31-201DH
500	5	S31-211AF	S31-211BF	S31-211CF	S31-211DF
	7,5	S31-211AG	S31-211BG	S31-211CG	S31-211DG
	10	S31-211AH	S31-211BH	S31-211CH	S31-211DH
	15	S31-211AJ	S31-211BJ		
600	5	S31-221AF	S31-221BF	S31-221CF	S31-221DF
	7,5	S31-221AG	S31-221BG	S31-221CG	S31-221DG
	10	S31-221AH	S31-221BH	S31-221CH	S31-221DH
	15	S31-221AJ	S31-221BJ		
750	5	S31-231AF	S31-231BF	S31-231CF	S31-231DF
	7,5	S31-231AG	S31-231BG	S31-231CG	S31-231DG
	10	S31-231AH	S31-231BH	S31-231CH	S31-231DH
	15	S31-231AJ	S31-231BJ		
800	5	S31-241AF	S31-241BF	S31-241CF	S31-241DF
	7,5	S31-241AG	S31-241BG	S31-241CG	S31-241DG
	10	S31-241AH	S31-241BH	S31-241CH	S31-241DH
	15	S31-241AJ	S31-241BJ		

		Best.-Nr.
	Schnappbefestigung	-
	Plombierplatte	-

ASR

ASG

AS / ASK

WSK

KBR / KBU

KSU / SUJK

NH

SASK

ASRD

ASKD / WSKD

CTB



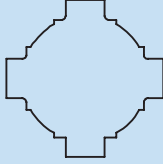
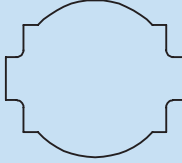
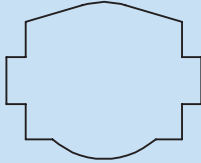

Schutz-Aufsteck-Stromwandler

SASK 541.4	Primärleiter		40 x 10 mm
	Rundleiter Wandlerbreite		2 x 30 x 15 mm Ø 32 mm 86 mm
SASK 51.4	Primärleiter		50 x 12 mm
	Rundleiter Wandlerbreite		2 x 40 x 10 mm Ø 44 mm 86 mm
SASK 51.6	Primärleiter		50 x 12 mm
	Rundleiter Wandlerbreite		40 x 30 mm Ø 40 mm 95 mm



SASK 541.4

Schutz-Aufsteck-Stromwandler



- Schiene 1 40 x 10 mm
- Schiene 2 2 x 30 x 5 mm
- Rundleiter 32 mm
- Baubreite 86 mm
- Bauhöhe 98,5 mm
- Bautiefe gesamt 58 mm

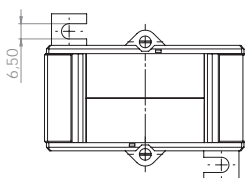
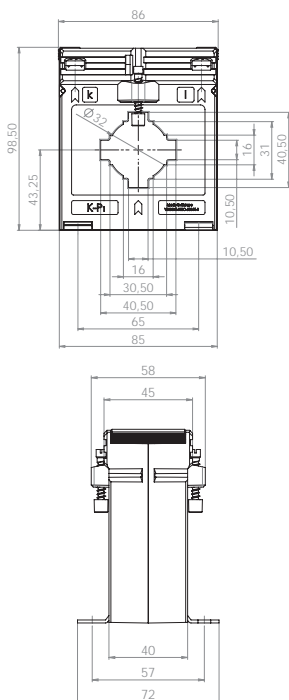

Primärstrom [A]	Bürde [VA]	Sekundärstrom [A] / Klasse			
		5 A Kl. 5P5 Best.-Nr.	5 A Kl. 10P5 Best.-Nr.	5 A Kl. 5P10 Best.-Nr.	5 A Kl. 10P10 Best.-Nr.
100	1	S33-1306B	S33-1307B		
	1,5	S33-1306C	S33-1307C		
125	1	S33-1506B	S33-1507B		
	1,5	S33-1506C	S33-1507C		
150	2,5		S33-1507D		
	1,5	S33-1606C	S33-1607C		
200	2,5	S33-1606D	S33-1607D		
	1,5	S33-1706C	S33-1707C		
250	2,5	S33-1706D	S33-1707D		
	1,5	S33-1806C	S33-1807C		S33-1809C
300	2,5	S33-1806D	S33-1807D		
	1,5	S33-1906C	S33-1907C	S33-1908C	S33-1909C
400	2,5	S33-1906D	S33-1907D		
	5		S33-1907F		
500	1,5	S33-2006C	S33-2007C	S33-2008C	S33-2009C
	2,5	S33-2006D	S33-2007D		
600	5	S33-2006F	S33-2007F		
	7,5		S33-2007G		
750	1,5	S33-2106C	S33-2107C	S33-2108C	S33-2109C
	2,5	S33-2106D	S33-2107D	S33-2108D	S33-2109D
1000	5	S33-2106F	S33-2107F		
	7,5		S33-2107G		
1000	1,5	S33-2206C	S33-2207C	S33-2208C	S33-2209C
	2,5	S33-2206D	S33-2207D	S33-2208D	S33-2209D
1000	5	S33-2206F	S33-2207F		
	7,5		S33-2207G		
1000	2,5	S33-2306D	S33-2307D	S33-2308D	S33-2309D
	5	S33-2306F	S33-2307F		
1000	7,5	S33-2306G	S33-2307G		
	10	S33-2306H	S33-2307H		
1000	2,5	S33-2506D	S33-2507D	S33-2508D	S33-2509D
	5	S33-2506F	S33-2507F		
1000	7,5	S33-2506G	S33-2507G		
	10	S33-2506H	S33-2507H		

		Best.-Nr.
	Schnappbefestigung	–
	Plombierplatte Form C	59042



SASK 541.4

Schutz-Aufsteck-Stromwandler

Schiene 1	40 x 10 mm
Schiene 2	2 x 30 x 5 mm
Rundleiter	32 mm
Baubreite	86 mm
Bauhöhe	98,5 mm
Bautiefe gesamt	58 mm

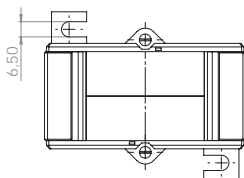
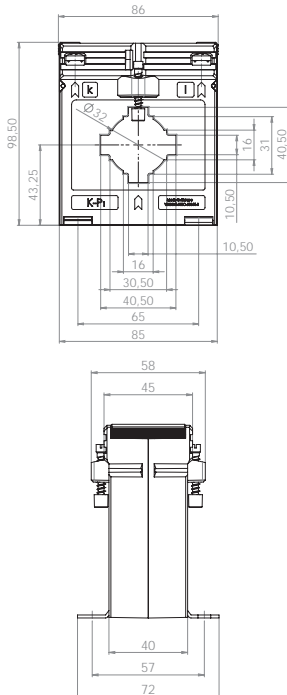

Primärstrom [A]	Bürde [VA]	Sekundärstrom [A] / Klasse			
		1 A Kl. 5P5 Best.-Nr.	1 A Kl. 10P5 Best.-Nr.	1 A Kl. 5P10 Best.-Nr.	1 A Kl. 10P10 Best.-Nr.
100	1	S33-1316B	S33-1317B		
	1,5	S33-1316C	S33-1317C		
125	1	S33-1516B	S33-1517B		
	1,5	S33-1516C	S33-1517C		
150	1,5	S33-1616C	S33-1617C		
	2,5	S33-1616D	S33-1617D		
200	1,5	S33-1716C	S33-1717C		
	2,5	S33-1716D	S33-1717D		
250	1,5	S33-1816C	S33-1817C	S33-1818C	S33-1819C
	2,5	S33-1816D	S33-1817D		
300	1,5	S33-1916C	S33-1917C	S33-1918C	S33-1919C
	2,5	S33-1916D	S33-1917D		
	5		S33-1917F		
400	1,5	S33-2016C	S33-2017C	S33-2018C	S33-2019C
	2,5	S33-2016D	S33-2017D		
	5	S33-2016F	S33-2017F		
500	1,5	S33-2116C	S33-2117C	S33-2118C	S33-2119C
	2,5	S33-2116D	S33-2117D	S33-2118D	S33-2119D
	5	S33-2116F	S33-2117F		
600	1,5	S33-2216C	S33-2217C	S33-2218C	S33-2219C
	2,5	S33-2216D	S33-2217D	S33-2218D	S33-2219D
	5	S33-2216F	S33-2217F		
	7,5		S33-2217G		
750	1,5	S33-2316C	S33-2317C	S33-2318C	S33-2319C
	2,5	S33-2316D	S33-2317D	S33-2318D	S33-2319D
	5	S33-2316F	S33-2317F		
	7,5	S33-2316G	S33-2317G		
	10	S33-2316H	S33-2317H		
1000	2,5	S33-2516D	S33-2517D	S33-2518D	S33-2519D
	5	S33-2516F	S33-2517F		S33-2519F
	7,5	S33-2516G	S33-2517G		
	10	S33-2516H	S33-2517H		

		Best.-Nr.
	Schnappbefestigung	-
	Plombierplatte Form C	59042

ASR

ASG

AS / ASK

WSK

KBR / KBU

KSU / SUJK

NH

SASK

ASRD

ASKD / WSKD

CTB



SASK 51.4



Schutz-Aufsteck-Stromwandler

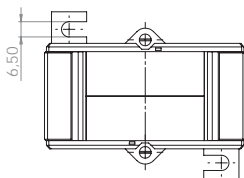
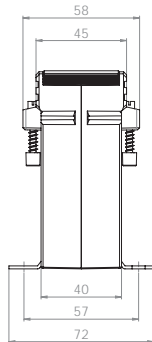
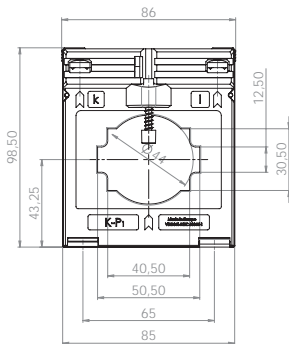

Schiene 1	50 x 12 mm
Schiene 2	2 x 40 x 10 mm
Rundleiter	44 mm
Baubreite	86 mm
Bauhöhe	98,5 mm
Bautiefe gesamt	58 mm



Primärstrom [A]	Bürde [VA]	Sekundärstrom [A] / Klasse			
		5 A Kl. 5P5 Best.-Nr.	5 A Kl. 10P5 Best.-Nr.	1 A Kl. 5P5 Best.-Nr.	1 A Kl. 10P5 Best.-Nr.
150	1			S34-1616B	S34-1617B
200	1	S34-1706B	S34-1707B	S34-1716B	S34-1717B
	1,5		S34-1707C	S34-1716C	S34-1717C
250	1,5	S34-1806C	S34-1807C	S34-1816C	S34-1817C
	2,5				S34-1817D
300	1,5	S34-1906C	S34-1907C	S34-1916C	S34-1917C
	2,5			S34-1916D	S34-1917D
400	1,5	S34-2006C	S34-2007C	S34-2016C	S34-2017C
	2,5		S34-2007D	S34-2016D	S34-2017D
500	1,5	S34-2106C	S34-2107C	S34-2116C	S34-2117C
	2,5		S34-2107D	S34-2116D	S34-2117D
600	1,5	S34-2206C	S34-2207C	S34-2216C	S34-2217C
	2,5		S34-2207D	S34-2216D	S34-2217D
750	1,5	S34-2306C	S34-2307C	S34-2316C	S34-2317C
	2,5	S34-2306D	S34-2307D	S34-2316D	S34-2317D
1000	1,5	S34-2506C	S34-2507C	S34-2516C	S34-2517C
	2,5	S34-2506D	S34-2507D	S34-2516D	S34-2517D

		Best.-Nr.
	Schnappbefestigung	–
	Plombierplatte Form C	59042



MBS AG



SASK 51.6

Schutz-Aufsteck-Stromwandler



- Schiene 1 50 x 12 mm
- Schiene 2 40 x 30 mm
- Rundleiter 40 mm
- Baubreite 95 mm
- Bauhöhe 116 mm
- Bautiefe gesamt 74 mm

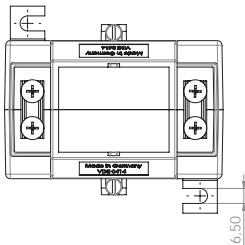
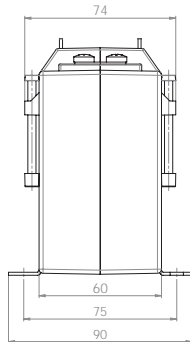
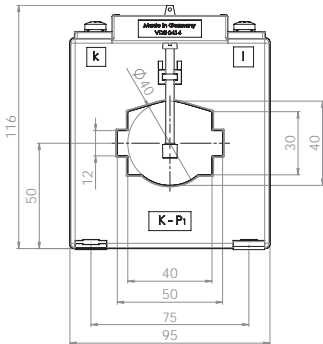

Primärstrom [A]	Bürde [VA]	Sekundärstrom [A] / Klasse			
		5 A Kl. 5P5 Best.-Nr.	5 A Kl. 10P5 Best.-Nr.	5 A Kl. 5P10 Best.-Nr.	5 A Kl. 10P10 Best.-Nr.
150	1,5	S37-1606C	S37-1607C	S37-1608C	S37-1609C
	2,5	S37-1606D	S37-1607D		S37-1609D
	5	S37-1606F	S37-1607F		
200	1,5	S37-1706C	S37-1707C	S37-1708C	S37-1709C
	2,5	S37-1706D	S37-1707D	S37-1708D	S37-1709D
	5	S37-1706F	S37-1707F		
250	2,5	S37-1806D	S37-1807D	S37-1808D	S37-1809D
	5	S37-1806F	S37-1807F		
	7,5		S37-1807G		
300	2,5	S37-1906D	S37-1907D	S37-1908D	S37-1909D
	5	S37-1906F	S37-1907F		
	7,5	S37-1906G	S37-1907G		
400	10		S37-1907H		
	2,5	S37-2006D	S37-2007D	S37-2008D	S37-2009D
	5	S37-2006F	S37-2007F	S37-2008F	S37-2009F
	7,5	S37-2006G	S37-2007G		
500	10	S37-2006H	S37-2007H		
	2,5	S37-2106D	S37-2107D	S37-2108D	S37-2109D
	5	S37-2106F	S37-2107F	S37-2108F	S37-2109F
	7,5	S37-2106G	S37-2107G		
600	10	S37-2106H	S37-2107H		
	15		S37-2107J		
	2,5	S37-2206D	S37-2207D	S37-2208D	S37-2209D
	5	S37-2206F	S37-2207F	S37-2208F	S37-2209F
750	7,5	S37-2206G	S37-2207G		
	10	S37-2206H	S37-2207H		
	15	S37-2206J	S37-2207J		
	2,5	S37-2306D	S37-2307D	S37-2308D	S37-2309D
1000	5	S37-2306F	S37-2307F	S37-2308F	S37-2309F
	7,5	S37-2306G	S37-2307G	S37-2308G	S37-2309G
	10	S37-2306H	S37-2307H		
	15	S37-2306J	S37-2307J		
1000	2,5	S37-2506D	S37-2507D	S37-2508D	S37-2509D
	5	S37-2506F	S37-2507F	S37-2508F	S37-2509F
	7,5	S37-2506G	S37-2507G	S37-2508G	S37-2509G
	10	S37-2506H	S37-2507H		
	15	S37-2506J	S37-2507J		

		Best.-Nr.
	Schnappbefestigung	-
	Plombierplatte Form E	59044

ASR

ASG

AS / ASK

WSK

KBR / KBU

KSU / SUJK

NH

SASK

ASRD

ASKD / WSKD

CTB



MBS AG



SASK 51.6

Schutz-Aufsteck-Stromwandler



Schiene 1	50 x 12 mm
Schiene 2	40 x 30 mm
Rundleiter	40 mm
Baubreite	95 mm
Bauhöhe	116 mm
Bautiefe gesamt	74 mm

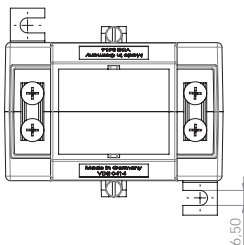
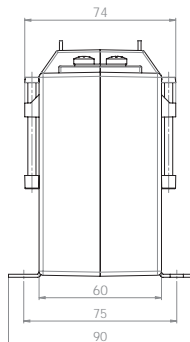
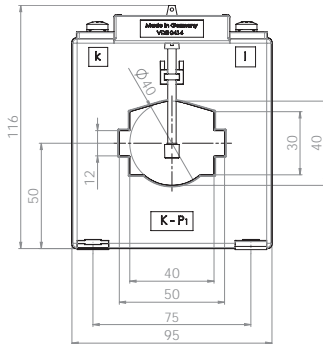





Primärstrom [A]	Bürde [VA]	Sekundärstrom [A] / Klasse			
		1 A Kl. 5P5 Best.-Nr.	1 A Kl. 10P5 Best.-Nr.	1 A Kl. 5P10 Best.-Nr.	1 A Kl. 10P10 Best.-Nr.
150	1,5	S37-1616C	S37-1617C	S37-1618C	S37-1619C
	2,5	S37-1616D	S37-1617D		S37-1619D
	5	S37-1616F	S37-1617F		
200	1,5	S37-1716C	S37-1717C	S37-1718C	S37-1719C
	2,5	S37-1716D	S37-1717D	S37-1718D	S37-1719D
	5	S37-1716F	S37-1717F		
250	2,5	S37-1816D	S37-1817D	S37-1818D	S37-1819D
	5	S37-1816F	S37-1817F		
	7,5		S37-1817G		
300	2,5	S37-1916D	S37-1917D	S37-1918D	S37-1919D
	5	S37-1916F	S37-1917F		
	7,5		S37-1917G		
400	2,5	S37-2016D	S37-2017D	S37-2018D	S37-2019D
	5	S37-2016F	S37-2017F	S37-2018F	S37-2019F
	7,5	S37-2016G	S37-2017G		
	10	S37-2016H	S37-2017H		
500	2,5	S37-2116D	S37-2117D	S37-2118D	S37-2119D
	5	S37-2116F	S37-2117F	S37-2118F	S37-2119F
	7,5	S37-2116G	S37-2117G		
	10	S37-2116H	S37-2117H		
600	2,5	S37-2216D	S37-2217D	S37-2218D	S37-2219D
	5	S37-2216F	S37-2217F	S37-2218F	S37-2219F
	7,5	S37-2216G	S37-2217G		
	10	S37-2216H	S37-2217H		
750	2,5	S37-2316D	S37-2317D	S37-2318D	S37-2319D
	5	S37-2316F	S37-2317F	S37-2318F	S37-2319F
	7,5	S37-2316G	S37-2317G		
	10	S37-2316H	S37-2317H		
1000	2,5	S37-2516D	S37-2517D	S37-2518D	S37-2519D
	5	S37-2516F	S37-2517F	S37-2518F	S37-2519F
	7,5	S37-2516G	S37-2517G	S37-2518G	S37-2519G
	10	S37-2516H	S37-2517H		
	15	S37-2516J	S37-2517J		

		Best.-Nr.
	Schnappbefestigung	–
	Plombierplatte Form E	59044

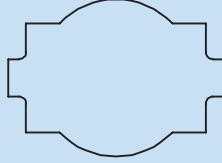

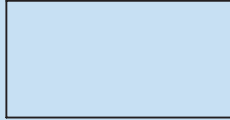
Schutz-Aufsteck-Stromwandler

SASK 61.4	Primärleiter		60 x 10 mm
	Rundleiter Wandlerbreite		2 x 50 x 10 mm Ø 44 mm 96 mm
SASK 61.10	Primärleiter		60 x 10 mm
	Wandlerbreite		50 x 30 mm 150 mm
SASK 63.6	Primärleiter		60 x 30 mm
	Rundleiter Wandlerbreite		Ø 30 mm 88 mm
SASK 105.6	Primärleiter		100 x 55 mm
	Rundleiter Wandlerbreite		Ø 55 mm 129 mm



MBS AG



SASK 61.4



Schutz-Aufsteck-Stromwandler

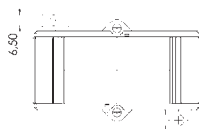
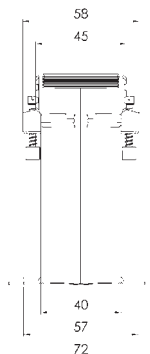
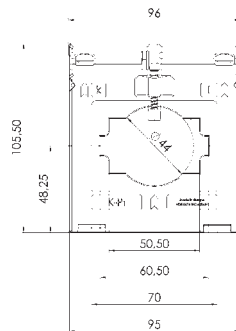

Schiene 1	60 x 10 mm
Schiene 2	2 x 50 x 10 mm
Rundleiter	44 mm
Baubreite	96 mm
Bauhöhe	105,5 mm
Bautiefe gesamt	58 mm



Primärstrom [A]	Bürde [VA]	Sekundärstrom [A] / Klasse			
		5 A Kl. 5P5 Best.-Nr.	5 A Kl. 10P5 Best.-Nr.	1 A Kl. 5P5 Best.-Nr.	1 A Kl. 10P5 Best.-Nr.
200	1	S41-1706B	S41-1707B	S41-1716B	S41-1717B
	1,5	S41-1706C	S41-1707C	S41-1716C	S41-1717C
250	1	S41-1806B	S41-1807B	S41-1816B	S41-1817B
	1,5	S41-1806C	S41-1807C	S41-1816C	S41-1817C
300	1,5	S41-1906C	S41-1907C	S41-1916C	S41-1917C
	2,5		S41-1907D	S41-1916D	S41-1917D
400	1,5	S41-2006C	S41-2007C	S41-2016C	S41-2017C
	2,5	S41-2006D	S41-2007D	S41-2016D	S41-2017D
500	1,5	S41-2106C	S41-2107C	S41-2116C	S41-2117C
	2,5	S41-2106D	S41-2107D	S41-2116D	S41-2117D
600	1,5	S41-2206C	S41-2207C	S41-2216C	S41-2217C
	2,5	S41-2206D	S41-2207D	S41-2216D	S41-2217D
	5			S41-2216F	S41-2217F
750	1,5	S41-2306C	S41-2307C	S41-2316C	S41-2317C
	2,5	S41-2306D	S41-2307D	S41-2316D	S41-2317D
	5	S41-2307F		S41-2316F	S41-2317F
1000	1,5	S41-2506C	S41-2507C	S41-2516C	S41-2517C
	2,5	S41-2506D	S41-2507D	S41-2516D	S41-2517D
	5	S41-2506F	S41-2507F	S41-2516F	S41-2517F
1200	1,5	S41-2606C	S41-2607C	S41-2616C	S41-2617C
	2,5	S41-2606D	S41-2607D	S41-2616D	S41-2617D
	5	S41-2606F	S41-2607F	S41-2616F	S41-2617F
1250	1,5	S41-2706C	S41-2707C	S41-2716C	S41-2717C
	2,5	S41-2706D	S41-2707D	S41-2716D	S41-2717D
	5	S41-2706F	S41-2707F	S41-2716F	S41-2717F

		Best.-Nr.
	Schnappbefestigung	–
	Plombierplatte Form C	59042



SASK 61.10

Schutz-Aufsteck-Stromwandler



- Schiene 1 60 x 10 mm
- Schiene 2 50 x 30 mm
- Baubreite 150 mm
- Bauhöhe 175,5 mm
- Bautiefe gesamt 114 mm

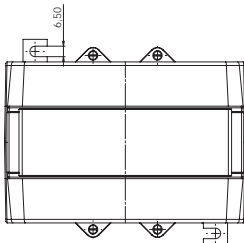
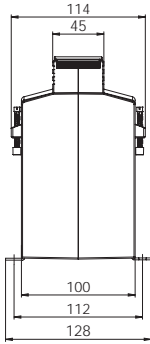
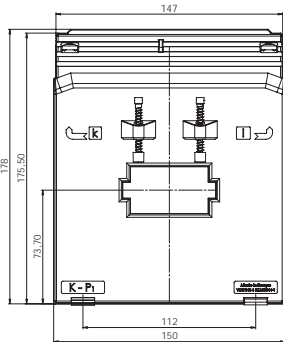

Primärstrom [A]	Bürde [VA]	Sekundärstrom [A] / Klasse			
		5 A Kl. 5P5 Best.-Nr.	5 A Kl. 10P5 Best.-Nr.	5 A Kl. 5P10 Best.-Nr.	5 A Kl. 10P10 Best.-Nr.
100	2,5	S50-1306D	S50-1307D	S50-1308D	S50-1309D
	5	S50-1306F	S50-1307F		
150	5	S50-1606F	S50-1607F	S50-1608F	S50-1609F
	7,5	S50-1606G	S50-1607G		
200	10	S50-1606H	S50-1607H		
	5	S50-1706F	S50-1707F	S50-1708F	S50-1709F
	7,5	S50-1706G	S50-1707G		
250	10	S50-1706H	S50-1707H		
	15	S50-1706J	S50-1707J		
	5	S50-1806F	S50-1807F	S50-1808F	S50-1809F
300	7,5	S50-1806G	S50-1807G		S50-1809G
	10	S50-1806H	S50-1807H	S50-1908H	S50-1809H
	15	S50-1806J	S50-1807J		
400	5	S50-1906F	S50-1907F	S50-1908F	S50-1909F
	7,5	S50-1906G	S50-1907G	S50-1908G	S50-1909G
	10	S50-1906H	S50-1907H		S50-1909H
500	15	S50-1906J	S50-1907J		
	5	S50-2006F	S50-2007F	S50-2008F	S50-2009F
	7,5	S50-2006G	S50-2007G	S50-2008G	S50-2009G
600	10	S50-2006H	S50-2007H	S50-2008H	S50-2009H
	15	S50-2006J	S50-2007J		S50-2009J
	5	S50-2106F	S50-2107F	S50-2108F	S50-2109F
750	7,5	S50-2106G	S50-2107G	S50-2108G	S50-2109G
	10	S50-2106H	S50-2107H	S50-2108H	S50-2109H
	15	S50-2106J	S50-2107J	S50-2108J	S50-2109J
1000	5	S50-2206F	S50-2207F	S50-2208F	S50-2209F
	7,5	S50-2206G	S50-2207G	S50-2208G	S50-2209G
	10	S50-2206H	S50-2207H	S50-2208H	S50-2209H
1200	15	S50-2206J	S50-2207J	S50-2208J	S50-2209J
	5	S50-2306F	S50-2307F	S50-2308F	S50-2309F
	7,5	S50-2306G	S50-2307G	S50-2308G	S50-2309G
1250	10	S50-2306H	S50-2307H	S50-2308H	S50-2309H
	15	S50-2306J	S50-2307J	S50-2308J	S50-2309J
	5	S50-2506F	S50-2507F	S50-2508F	S50-2509F
1500	7,5	S50-2506G	S50-2507G	S50-2508G	S50-2509G
	10	S50-2506H	S50-2507H	S50-2508H	S50-2509H
	15	S50-2506J	S50-2507J	S50-2508J	S50-2509J
1200	5	S50-2606F	S50-2607F	S50-2608F	S50-2609F
	7,5	S50-2606G	S50-2607G	S50-2608G	S50-2609G
	10	S50-2606H	S50-2607H	S50-2608H	S50-2609H
1250	15	S50-2606J	S50-2607J	S50-2608J	S50-2609J
	5	S50-2706F	S50-2707F	S50-2708F	S50-2709F
	7,5	S50-2706G	S50-2707G	S50-2708G	S50-2709G
1500	10	S50-2706H	S50-2707H	S50-2708H	S50-2709H
	15	S50-2706J	S50-2707J	S50-2708J	S50-2709J
	5	S50-2806F	S50-2807F	S50-2808F	S50-2809F
1500	7,5	S50-2806G	S50-2807G	S50-2808G	S50-2809G
	10	S50-2806H	S50-2807H	S50-2808H	S50-2809H
	15	S50-2806J	S50-2807J	S50-2808J	S50-2809J

ASR

ASG

AS / ASK

WSK

KBR / KBU

KSU / SUJK

NH

SASK

ASRD

ASKD / WSKD

CTB



SASK 61.10

Schutz-Aufsteck-Stromwandler



Schiene 1	60 x 10 mm
Schiene 2	50 x 30 mm
Baubreite	150 mm
Bauhöhe	175,5 mm
Bautiefe gesamt	114 mm

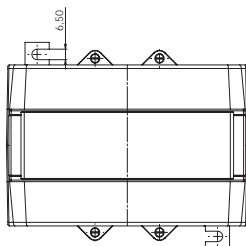
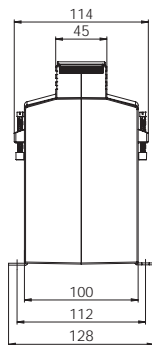
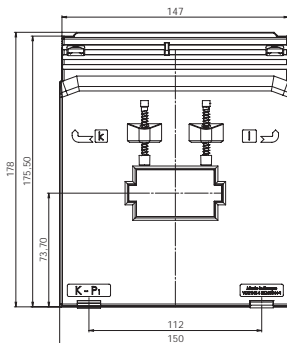

Primärstrom [A]	Bürde [VA]	Sekundärstrom [A] / Klasse			
		5 A Kl. 5P15 Best.-Nr.	5 A Kl. 10P15 Best.-Nr.	5 A Kl. 5P20 Best.-Nr.	5 A Kl. 10P20 Best.-Nr.
150	2,5	S50-160AD	S50-160BD		
200	2,5	S50-170AD	S50-170BD	S50-170CD	S50-170DD
250	2,5	S50-180AD	S50-180BD	S50-180CD	S50-180DD
	5	S50-180AF	S50-180BF		
300	2,5	S50-190AD	S50-190BD	S50-190CD	S50-190DD
	5	S50-190AF	S50-190BF		S50-190DF
400	5	S50-200AF	S50-200BF	S50-200CF	S50-200DF
500	5	S50-210AF	S50-210BF	S50-210CF	S50-210DF
	7,5	S50-210AG	S50-210BG		
	10	S50-210AH	S50-210BH		
600	5	S50-220AF	S50-220BF	S50-220CF	S50-220DF
	7,5	S50-220AG	S50-220BG		
	10	S50-220AH	S50-220BH		
750	5	S50-230AF	S50-230BF	S50-230CF	S50-230DF
	7,5	S50-230AG	S50-230BG		
	10	S50-230AH	S50-230BH		
1000	5	S50-250AF	S50-250BF	S50-250CF	S50-250DF
	7,5	S50-250AG	S50-250BG		
	10	S50-250AH	S50-250BH		
1200	5	S50-260AF	S50-260BF	S50-260CF	S50-260DF
	7,5	S50-260AG	S50-260BG		
	10	S50-260AH	S50-260BH		
1250	5	S50-270AF	S50-270BF	S50-270CF	S50-270DF
	7,5	S50-270AG	S50-270BG		
	10	S50-270AH	S50-270BH		
1500	5	S50-280AF	S50-280BF	S50-280CF	S50-280DF
	7,5	S50-280AG	S50-280BG		
	10	S50-280AH	S50-280BH		
	15		S50-280BJ		

		Best.-Nr.
	Schnappbefestigung	–
	Plombierplatte	–



SASK 61.10

Schutz-Aufsteck-Stromwandler



- Schiene 1 60 x 10 mm
- Schiene 2 50 x 30 mm
- Baubreite 150 mm
- Bauhöhe 175,5 mm
- Bautiefe gesamt 114 mm

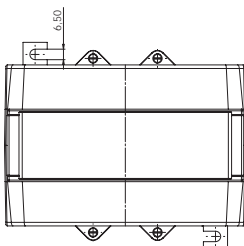
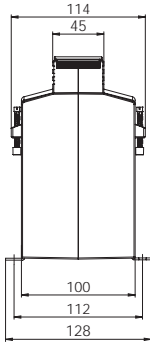
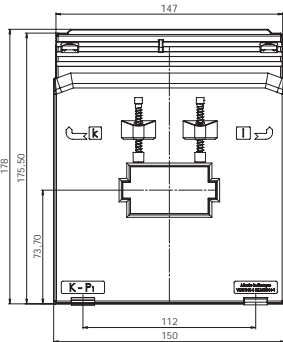

Primärstrom [A]	Bürde [VA]	Sekundärstrom [A] / Klasse			
		1 A Kl. 5P5 Best.-Nr.	1 A Kl. 10P5 Best.-Nr.	1 A Kl. 5P10 Best.-Nr.	1 A Kl. 10P10 Best.-Nr.
100	2,5	S50-1316D	S50-1317D	S50-1318D	S50-1319D
	5	S50-1316F	S50-1317F		
150	5	S50-1616F	S50-1617F	S50-1618F	S50-1619F
	7,5	S50-1616G	S50-1617G		
200	10	S50-1616H	S50-1617H		
	5	S50-1716F	S50-1717F	S50-1718F	S50-1719F
	7,5	S50-1716G	S50-1717G		
250	10	S50-1716H	S50-1717H		
	15	S50-1716J	S50-1717J		
	5	S50-1816F	S50-1817F	S50-1818F	S50-1819F
300	7,5	S50-1816G	S50-1817G		S50-1819G
	10	S50-1816H	S50-1817H	S50-1918H	S50-1819H
	15	S50-1816J	S50-1817J		
400	5	S50-1916F	S50-1917F	S50-1918F	S50-1919F
	7,5	S50-1916G	S50-1917G	S50-1918G	S50-1919G
	10	S50-1916H	S50-1917H		S50-1919H
500	15	S50-1916J	S50-1917J		
	5	S50-2016F	S50-2017F	S50-2018F	S50-2019F
	7,5	S50-2016G	S50-2017G	S50-2018G	S50-2019G
600	10	S50-2016H	S50-2017H	S50-2018H	S50-2019H
	15	S50-2016J	S50-2017J		S50-2019J
	5	S50-2116F	S50-2117F	S50-2118F	S50-2119F
750	7,5	S50-2116G	S50-2117G	S50-2118G	S50-2119G
	10	S50-2116H	S50-2117H	S50-2118H	S50-2119H
	15	S50-2116J	S50-2117J	S50-2118J	S50-2119J
1000	5	S50-2216F	S50-2217F	S50-2218F	S50-2219F
	7,5	S50-2216G	S50-2217G	S50-2218G	S50-2219G
	10	S50-2216H	S50-2217H	S50-2218H	S50-2219H
1200	15	S50-2216J	S50-2217J	S50-2218J	S50-2219J
	5	S50-2316F	S50-2317F	S50-2318F	S50-2319F
	7,5	S50-2316G	S50-2317G	S50-2318G	S50-2319G
1250	10	S50-2316H	S50-2317H	S50-2318H	S50-2319H
	15	S50-2316J	S50-2317J	S50-2318J	S50-2319J
	5	S50-2516F	S50-2517F	S50-2518F	S50-2519F
1500	7,5	S50-2516G	S50-2517G	S50-2518G	S50-2519G
	10	S50-2516H	S50-2517H	S50-2518H	S50-2519H
	15	S50-2516J	S50-2517J	S50-2518J	S50-2519J
1200	5	S50-2616F	S50-2617F	S50-2618F	S50-2619F
	7,5	S50-2616G	S50-2617G	S50-2618G	S50-2619G
	10	S50-2616H	S50-2617H	S50-2618H	S50-2619H
1250	15	S50-2616J	S50-2617J	S50-2618J	S50-2619J
	5	S50-2716F	S50-2717F	S50-2718F	S50-2719F
	7,5	S50-2716G	S50-2717G	S50-2718G	S50-2719G
1500	10	S50-2716H	S50-2717H	S50-2718H	S50-2719H
	15	S50-2716J	S50-2717J	S50-2718J	S50-2719J
	5	S50-2816F	S50-2817F	S50-2818F	S50-2819F
1500	7,5	S50-2816G	S50-2817G	S50-2818G	S50-2819G
	10	S50-2816H	S50-2817H	S50-2818H	S50-2819H
	15	S50-2816J	S50-2817J	S50-2818J	S50-2819J

ASR

ASG

AS / ASK

WSK

KBR / KBU

KSU / SUJK

NH

SASK

ASRD

ASKD / WSKD

CTB



SASK 61.10

Schutz-Aufsteck-Stromwandler



Schiene 1	60 x 10 mm
Schiene 2	50 x 30 mm
Baubreite	150 mm
Bauhöhe	175,5 mm
Bautiefe gesamt	114 mm

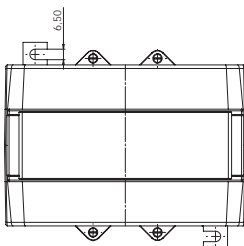
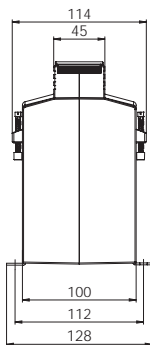
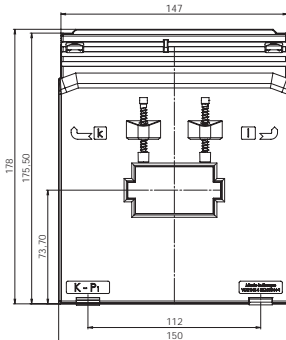

Primärstrom [A]	Bürde [VA]	Sekundärstrom [A] / Klasse			
		1 A Kl. 5P15 Best.-Nr.	1 A Kl. 10P15 Best.-Nr.	1 A Kl. 5P20 Best.-Nr.	1 A Kl. 10P20 Best.-Nr.
150	2,5	S50-161AD	S50-161BD		
200	2,5	S50-171AD	S50-171BD	S50-171CD	S50-171DD
250	2,5	S50-181AD	S50-181BD	S50-181CD	S50-181DD
	5	S50-181AF	S50-181BF		
300	2,5	S50-191AD	S50-191BD	S50-191CD	S50-191DD
	5	S50-191AF	S50-191BF		S50-191DF
400	5	S50-201AF	S50-201BF	S50-201CF	S50-201DF
500	5	S50-211AF	S50-211BF	S50-211CF	S50-211DF
	7,5	S50-211AG	S50-211BG		
	10	S50-211AH	S50-211BH		
600	5	S50-221AF	S50-221BF	S50-221CF	S50-221DF
	7,5	S50-221AG	S50-221BG		
	10	S50-221AH	S50-221BH		
750	5	S50-231AF	S50-231BF	S50-231CF	S50-231DF
	7,5	S50-231AG	S50-231BG		
	10	S50-231AH	S50-231BH		
1000	5	S50-251AF	S50-251BF	S50-251CF	S50-251DF
	7,5	S50-251AG	S50-251BG		
	10	S50-251AH	S50-251BH		
1200	5	S50-261AF	S50-261BF	S50-261CF	S50-261DF
	7,5	S50-261AG	S50-261BG		
	10	S50-261AH	S50-261BH		
1250	5	S50-271AF	S50-271BF	S50-271CF	S50-271DF
	7,5	S50-271AG	S50-271BG		
	10	S50-271AH	S50-271BH		
1500	5	S50-281AF	S50-281BF	S50-281CF	S50-281DF
	7,5	S50-281AG	S50-281BG		
	10	S50-281AH	S50-281BH		
	15		S50-281BJ		

		Best.-Nr.
	Schnappbefestigung	-
	Plombierplatte	-



SASK 63.6

Schutz-Aufsteck-Stromwandler



- Schiene 1 60 x 30 mm
- Rundleiter 30 mm
- Baubreite 88 mm
- Bauhöhe 129 mm
- Bautiefe gesamt 78 mm

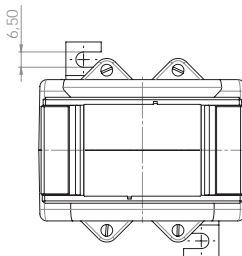
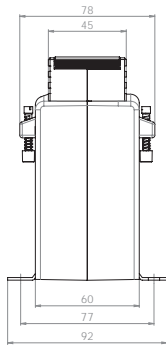
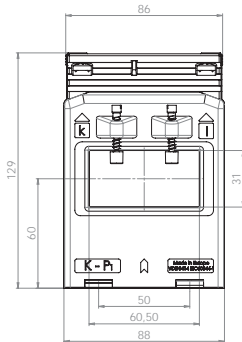

Primärstrom [A]	Bürde [VA]	Sekundärstrom [A] / Klasse			
		5 A Kl. 5P5 Best.-Nr.	5 A Kl. 10P5 Best.-Nr.	1 A Kl. 5P5 Best.-Nr.	1 A Kl. 10P5 Best.-Nr.
200	1,5	S46-1706C	S46-1707C	S46-1716C	S46-1717C
	2,5		S46-1707D	S46-1716D	S46-1717D
250	1,5	S46-1806C	S46-1807C	S46-1816C	S46-1817C
	2,5	S46-1806D	S46-1807D	S46-1816D	S46-1817D
300	1,5	S46-1906C	S46-1907C	S46-1916C	S46-1917C
	2,5	S46-1906D	S46-1907D	S46-1916D	S46-1917D
400	2,5	S46-2006D	S46-2007D	S46-2016D	S46-2017D
	5		S46-2007F	S46-2016F	S46-2017F
	2,5	S46-2106D	S46-2107D	S46-2116D	S46-2117D
500	5	S46-2106F	S46-2107F	S46-2116F	S46-2117F
	2,5	S46-2206D	S46-2207D	S46-2216D	S46-2217D
	5	S46-2206F	S46-2207F	S46-2216F	S46-2217F
750	2,5	S46-2306D	S46-2307D	S46-2316D	S46-2317D
	5	S46-2306F	S46-2307F	S46-2316F	S46-2317F
1000	2,5	S46-2506D	S46-2507D	S46-2516D	S46-2517D
	5	S46-2506F	S46-2507F	S46-2516F	S46-2517F

		Best.-Nr.
	Schnappbefestigung	-
	Plombierplatte Form C	59042

ASR

ASG

AS / ASK

WSK

KBR / KBU

KSU / SUJK

NH

SASK

ASRD

ASKD / WSKD

CTB



MBS AG



SASK 105.6

Schutz-Aufsteck-Stromwandler



Schiene 1	100 x 55 mm
Rundleiter	55 mm
Baubreite	129 mm
Bauhöhe	167 mm
Bautiefe gesamt	78 mm

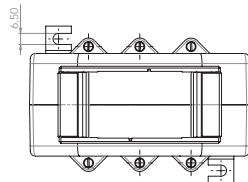
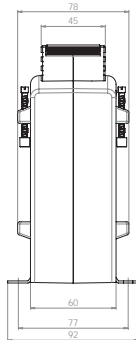
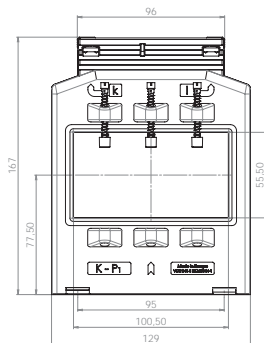

Primärstrom [A]	Bürde [VA]	Sekundärstrom [A] / Klasse			
		5 A Kl. 5P5 Best.-Nr.	5 A Kl. 10P5 Best.-Nr.	5 A Kl. 5P10 Best.-Nr.	5 A Kl. 10P10 Best.-Nr.
600	2,5	S56-2206C	S56-2207C	S56-2208D	S56-2209D
	5	S56-2206F	S56-2207F		S56-2209F
750	2,5	S56-2306C	S56-2307C	S56-2308D	S56-2309D
	5	S56-2306F	S56-2307F	S56-2308F	S56-2309F
	7,5	S56-2306G	S56-2307G		
	10	S56-2306H	S56-2307H		
1000	5	S56-2506F	S56-2507F	S56-2508F	S56-2509F
	7,5	S56-2506G	S56-2507G	S56-2508G	S56-2509G
	10	S56-2506H	S56-2507H		
1200	5	S56-2606F	S56-2607F	S56-2608F	S56-2609F
	7,5	S56-2606G	S56-2607G	S56-2608G	S56-2609G
	10	S56-2606H	S56-2607H		
	15	S56-2606J	S56-2607J		
1250	5	S56-2706F	S56-2707F	S56-2708F	S56-2709F
	7,5	S56-2706G	S56-2707G	S56-2708G	S56-2709G
	10	S56-2706H	S56-2707H		
	15	S56-2706J	S56-2707J		
1500	5	S56-2806F	S56-2807F	S56-2808F	S56-2809F
	7,5	S56-2806G	S56-2807G	S56-2808G	S56-2809G
	10	S56-2806H	S56-2807H		
	15	S56-2806J	S56-2807J		
1600	5			S56-2908F	S56-2909F
	7,5	S56-2906G	S56-2907G	S56-2908G	S56-2909G
	10	S56-2906H	S56-2907H		
	15	S56-2906J	S56-2907J		

		Best.-Nr.
	Schnappbefestigung	–
	Plombierplatte Form C	59042



SASK 105.6



Schutz-Aufsteck-Stromwandler

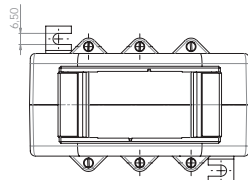
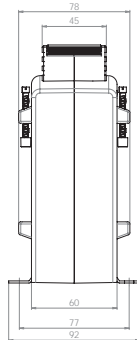
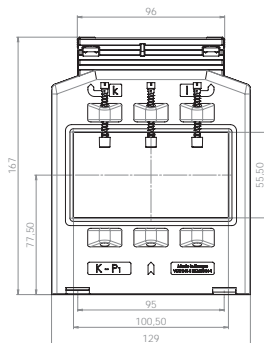

Schiene 1	100 x 55 mm
Rundleiter	55 mm
Baubreite	129 mm
Bauhöhe	167 mm
Bautiefe gesamt	78 mm



Primärstrom [A]	Bürde [VA]	Sekundärstrom [A] / Klasse			
		1 A Kl. 5P5 Best.-Nr.	1 A Kl. 10P5 Best.-Nr.	1 A Kl. 5P10 Best.-Nr.	1 A Kl. 10P10 Best.-Nr.
600	2,5	S56-2216C	S56-2217C	S56-2218D	S56-2219D
	5	S56-2216F	S56-2217F		S56-2219F
750	2,5	S56-2316C	S56-2317C	S56-2318D	S56-2319D
	5	S56-2316F	S56-2317F	S56-2318F	S56-2319F
	7,5	S56-2316G	S56-2317G		
	10	S56-2316H	S56-2317H		
1000	5	S56-2516F	S56-2517F	S56-2518F	S56-2519F
	7,5	S56-2516G	S56-2517G	S56-2518G	S56-2519G
	10	S56-2516H	S56-2517H		
1200	5	S56-2616F	S56-2617F	S56-2618F	S56-2619F
	7,5	S56-2616G	S56-2617G	S56-2618G	S56-2619G
	10	S56-2616H	S56-2617H		
	15	S56-2616J	S56-2617J		
1250	5	S56-2716F	S56-2717F	S56-2718F	S56-2719F
	7,5	S56-2716G	S56-2717G	S56-2718G	S56-2719G
	10	S56-2716H	S56-2717H		
	15	S56-2716J	S56-2717J		
1500	5	S56-2816F	S56-2817F	S56-2818F	S56-2819F
	7,5	S56-2816G	S56-2817G	S56-2818G	S56-2819G
	10	S56-2816H	S56-2817H		
	15	S56-2816J	S56-2817J		
1600	5			S56-2918F	S56-2919F
	7,5	S56-2916G	S56-2917G	S56-2918G	S56-2919G
	10	S56-2916H	S56-2917H		
	15	S56-2916J	S56-2917J		

		Best.-Nr.
	Schnappbefestigung	–
	Plombierplatte Form C	59042

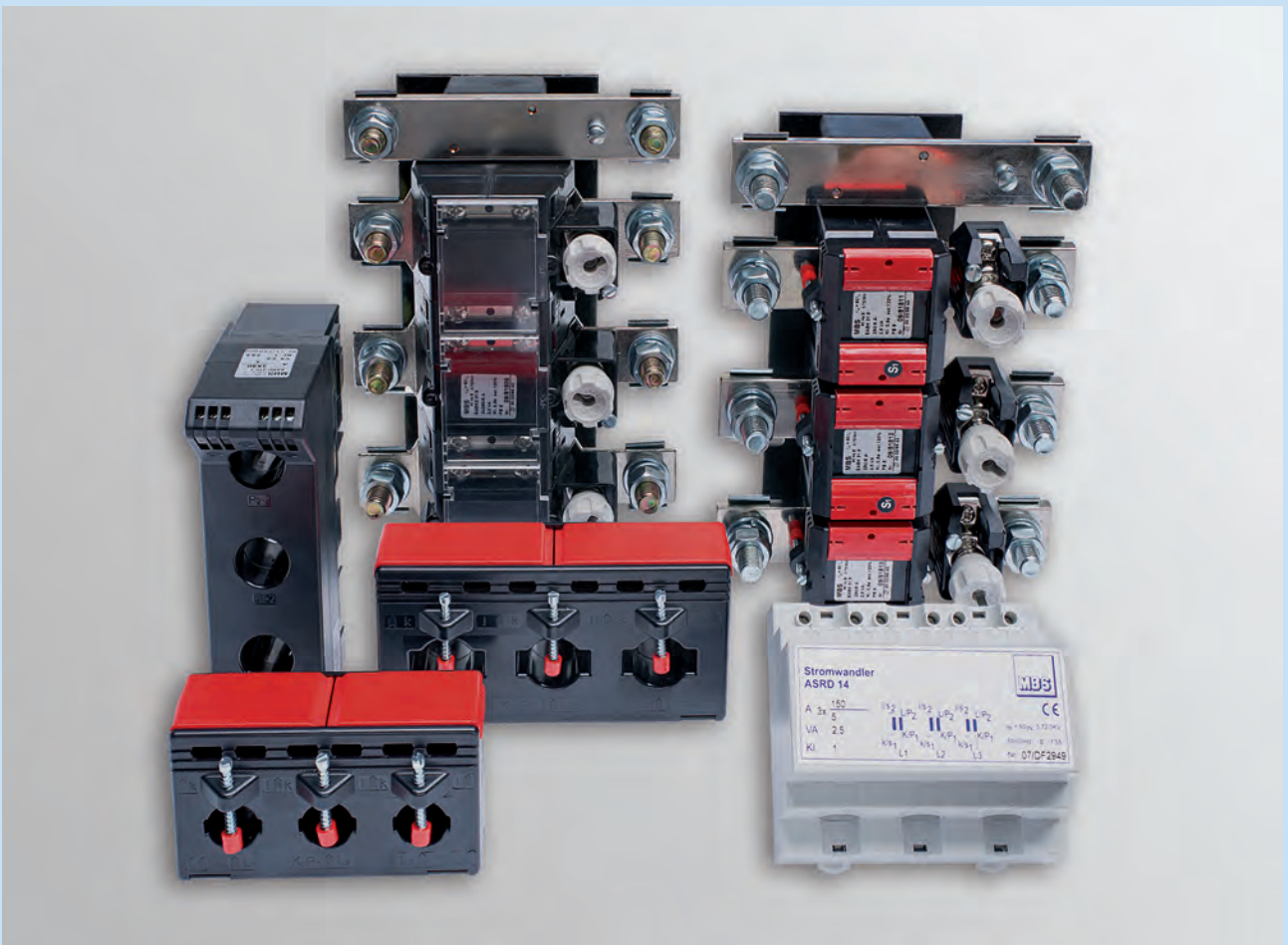



Dreiphasen-Stromwandler-Sätze

ASRD 14	Primärleiter Wandlerbreite	3 x 13,5 mm 105 mm
	für Normschienenmontage	
ASRD 210.3	Primärleiter Wandlerbreite	3 x 21,5 mm 49,6 mm
	Slim-Line-Leiste	
ASRD 205.37	Primärleiter Rundleiter Wandlerbreite	3 x 20 x 5 mm 18 mm 115 mm
ASRD 310.37	Primärleiter Rundleiter Wandlerbreite	3 x 30 x 10 mm 3 x 22 mm 150 mm
ASK(D) 21.3	mit Abdeckkappen aus Plexiglas	
ASK(D) 31.5 ASK(D) 31.5 2U	mit Abdeckkappen aus Plexiglas	
WSKD 31.8 ASKD 31.8	mit Abdeckkappen aus Plexiglas	



ASRD 14

Dreiphasen-Stromwandlersatz



Rundleiter 13,5 mm
 Baubreite 105 mm
 Bauhöhe 90 mm
 Bautiefe gesamt 54 mm

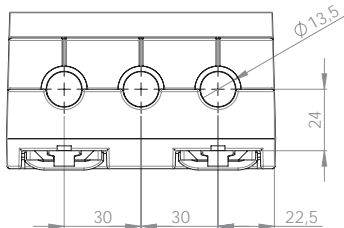
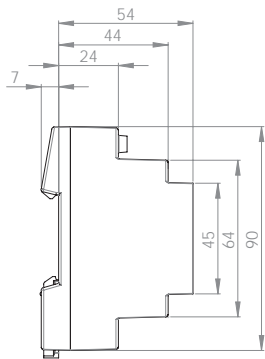
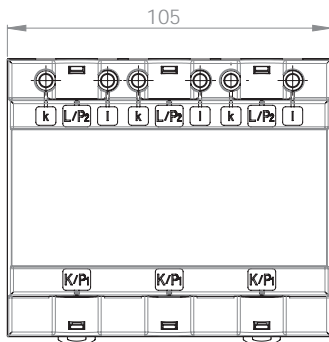

Primärstrom [A]	Bürde [VA]	Sekundärstrom [A] / Klasse			
		5 A Kl. 1 Best.-Nr.	5 A Kl. 0,5 Best.-Nr.	1 A Kl. 1 Best.-Nr.	1 A Kl. 0,5 Best.-Nr.
3 x 50	1	96030		96230	
3 x 60	1,25	96032		96232	
3 x 75	1,5	96034		96234	
3 x 80	1,5	96036		96236	
3 x 100	2,5	96038		96238	
3 x 125	2,5	96039	96014	96239	96214
3 x 150	2,5	96040	96017	96240	96217
	3,75	96044		96244	

		Best.-Nr.
	Schnappbefestigung	-
	Plombierplatte	-



ASRD 210.3

Dreiphasen-Stromwandlersatz



Rundleiter 21,5 mm
 Baubreite 49,6 mm
 Bauhöhe 156,6 mm
 Bautiefe gesamt 103 mm

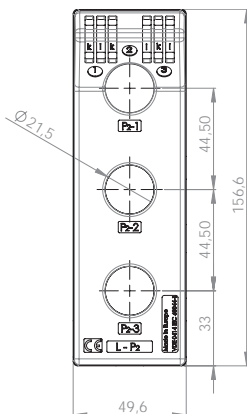
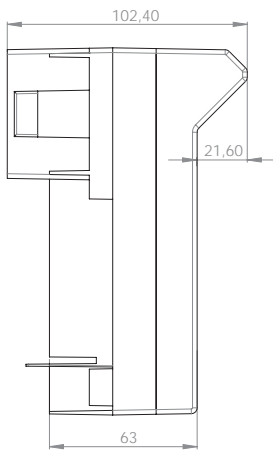
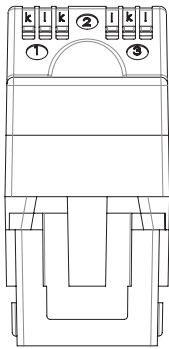

Primärstrom [A]	Bürde [VA]	Sekundärstrom [A] / Klasse			
		5 A Kl. 1 Best.-Nr.	5 A Kl. 0,5 Best.-Nr.	1 A Kl. 1 Best.-Nr.	1 A Kl. 0,5 Best.-Nr.
3 x 75	1,25	27703		27803	
	1,5	27704		27804	
3 x 80	1,25	27705		27805	
	1,5	27706		27806	
3 x 100	1,5	27707		27807	
	2,5	27708		27808	
3 x 125	1,5	27709		27809	
	2,5	27710		27810	
	3,75	27711		27811	
3 x 150	1,5	27712		27812	
	2,5	27713	27725	27813	27825
	3,75	27714		27814	
3 x 200	1,5	27715		27815	
	2,5	27716		27816	
	5	27717		27817	
3 x 250	2,5	27718		27818	
	5	27719		27819	

		Best.-Nr.
	Schnappbefestigung	-
	Plombierplatte	-

ASR

ASG

AS / ASK

WSK

KBR / KBU

KSU / SUJK

NH

SASK

ASRD

WSKD / ASKD

CTB



MBS AG



ASRD 205.37

Dreiphasen-Stromwandlersatz



Primärstrom [A]	Bürde [VA]	Sekundärstrom [A] / Klasse	
		5 A Kl. 1 Best.-Nr.	1 A Kl. 1 Best.-Nr.
3 x 100	1	D205-010	D205-020
3 x 150	1,25	D205-011	D205-021
3 x 160	1,5	D205-014	D205-024
3 x 200	1,5	D205-012	D205-022
3 x 250	2,5	D205-013	D205-023

Schiene 1 20 x 5 mm
 Rundleiter 18 mm
 Baubreite 115 mm
 Bauhöhe 65 mm
 Bautiefe gesamt 37 mm

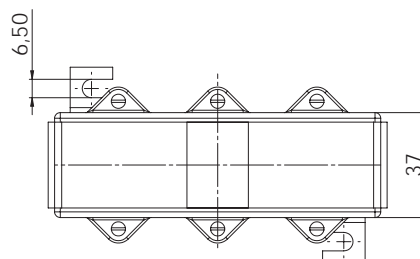
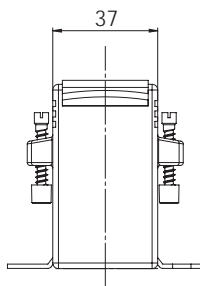
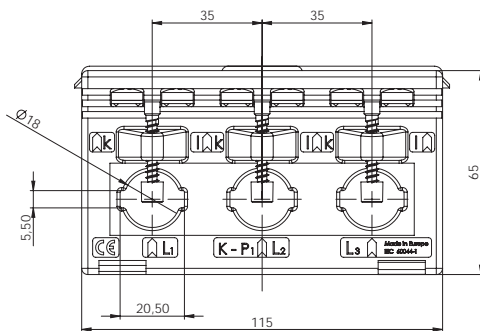



ASRD 310.37

Dreiphasen-Stromwandlersatz



- Schiene 1 30 x 10 mm
- Rundleiter 22 mm
- Baubreite 150 mm
- Bauhöhe 75 mm
- Bautiefe gesamt 37 mm

Primärstrom [A]	Bürde [VA]	Sekundärstrom [A] / Klasse	
		5 A Kl. 1 Best.-Nr.	1 A Kl. 1 Best.-Nr.
3 x 250	2,5	D310-010	D310-020
3 x 300	3,75	D310-011	D310-021
3 x 400	5	D310-012	D310-022
3 x 500	5	D310-013	D310-023
3 x 600	5	D310-014	D310-024

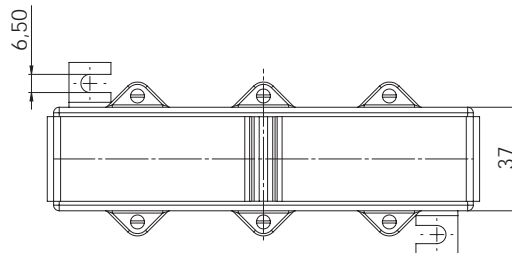
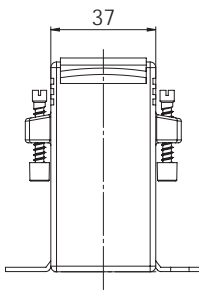
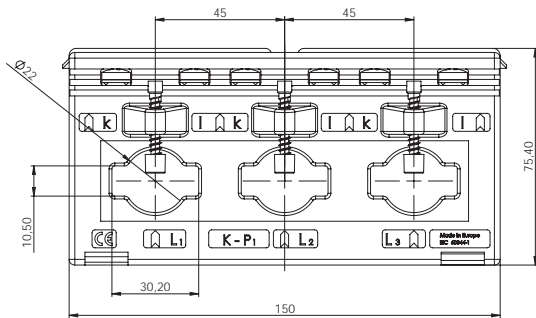

ASR

ASG

AS / ASK

WSK

KBR / KBU

KSU / SJSK

NH

SASK

ASRD

WSKD / ASKD

CTB



Dreiphasen-Stromwandler-Satz

ASK(D) 21.3

mit Abdeckkappen aus Plexiglas

Ausführung:

Der Messwandlersatz besteht aus 3 Einzelstromwandlern, welche gemeinsam mit den Primärleitern L_1 , L_2 , L_3 sowie einem Neutralleiter auf einer Bodenplatte aus Aluminium montiert sind.

Der Wandlersatz kann wahlweise mit bzw. ohne Sicherung geliefert werden. Der Spannungsabgriff kann dann sowohl über 10 A-NEOZED Sicherungselemente als auch direkt von den einzelnen Primärleitern erfolgen.

Die Sekundäranschlüsse der Stromwandler können durch die im Lieferumfang enthaltenen transparenten, plombierbaren Abdeckungen gegen Fremdeingriffe gesichert werden. Nach erfolgter Montage des Messwandlersatzes sind alle spannungsführenden Teile durch eine, ebenfalls im Lieferumfang enthaltene, Isolierabdeckung gegen Berührung geschützt.

Die am Wandlersatz angeordneten Primäranschlussklemmen gestatten den Anschluss flexibler Kupferleitungen mit einem Nennquerschnitt von 16 mm² bis 70 mm².

Die Ausführung dieses Wandlersatzes entspricht den Forderungen der technischen Normen und Richtlinien:

IEC 61869/1+2

DIN 42600

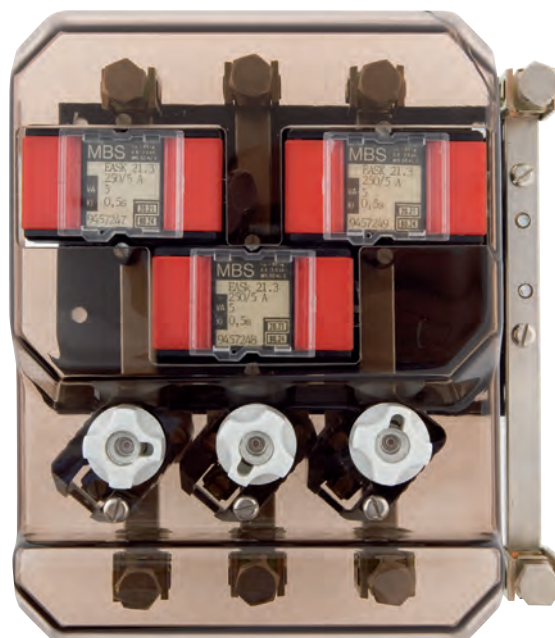





ASK(D) 21.3

Dreiphasen-Stromwandlersatz

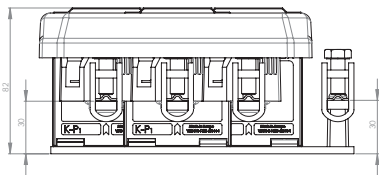

Primärstrom [A]	Bürde [VA]	Sekundärstrom [A] / Klasse			
		5 A Kl. 1 Best.-Nr.	5 A Kl. 0,5 Best.-Nr.	1 A Kl. 1 Best.-Nr.	1 A Kl. 0,5 Best.-Nr.
3 x 100	1,5	56027	56011	56227	56211
	2,5	56028	56012	56228	56212
3 x 150	1,5	56029	56013	56229	56213
	2,5	56030	56014	56230	56214
	5	56043	56015	56243	56215
3 x 200	1,5	56031	56016	56231	56216
	2,5	56032	56017	56232	56217
	5	56033	56018	56233	56218



		Best.-Nr.
	Schnappbefestigung	-
	Plombierplatte Form A	59040

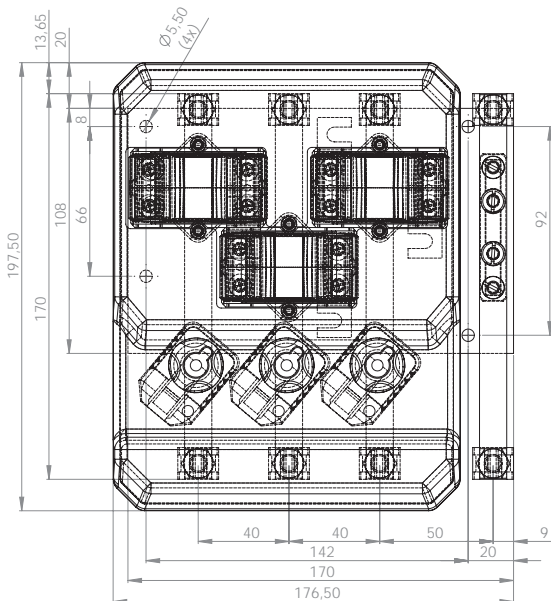
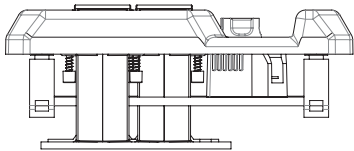

ASR

ASG

AS / ASK

WSK

KBR / KBU

KSU / SUJK

NH

SASK

ASRD

ASKD

CTB



Dreiphasen-Stromwandler-Satz

ASK(D) 31.5

ASK(D) 31.5 2U

mit Abdeckkappen aus Plexiglas

Ausführung:

Der Wandler Satz besteht aus 3 Einzelstromwandlern, welche gemeinsam mit den Primärleitern L_1 , L_2 , L_3 und einem Neutralleiter auf einer Bodenplatte aus Aluminium montiert sind. Die Sekundäranschlüsse aller Stromwandler sind durch plombierbare Abdeckungen gegen Fremdeingriffe geschützt.

Eine im Lieferumfang enthaltene, alle spannungsführenden Teile überdeckende Klarsichtabdeckung, stellt den gemäß VBG 4 geforderten Berührungsschutz sicher.

Alle Messwandlersätze können wahlweise mit bzw. ohne Sicherung geliefert werden. Der Spannungsabgriff vom Primärleiter erfolgt optional über 10 A-NEOZED Sicherungselemente oder über direkt auf die Stromschienen montierte Spannungsabgriffklemmen.

Dieser Wandler Satz entspricht IEC 61869/1+2 (vormals IEC 60044-1), DIN 42600.

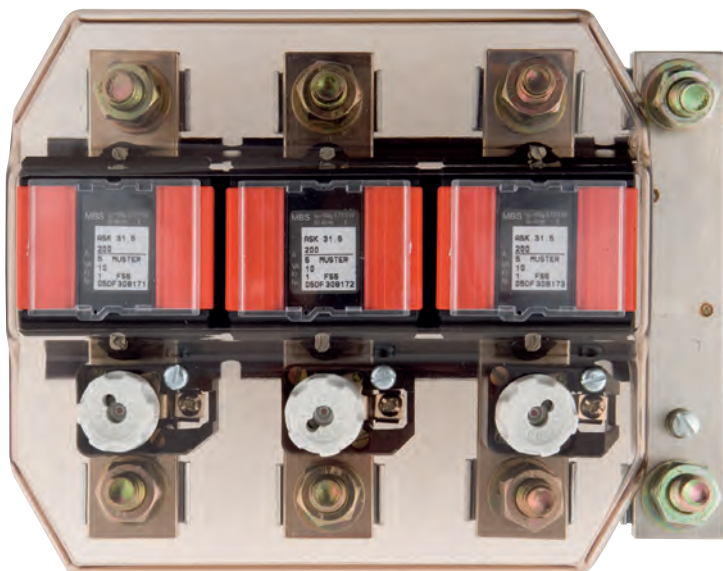



ASK(D) 31.5

Dreiphasen-Stromwandlersatz

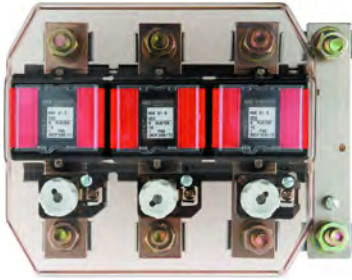

Primärstrom [A]	Bürde [VA]	Sekundärstrom [A] / Klasse			
		5 A Kl. 1 Best.-Nr.	5 A Kl. 0,5 Best.-Nr.	1 A Kl. 1 Best.-Nr.	1 A Kl. 0,5 Best.-Nr.
3 x 75	2,5	57043	57011	57243	57211
	5	57044	57012	57244	57212
3 x 100	2,5	57045	57013	57245	57213
	5	57046	57014	57246	57214
3 x 150	2,5	57047	57015	57247	57215
	5	57048	57016	57248	57216
3 x 200	2,5	57049	57017	57249	57217
	5	57050	57018	57250	57218
	10	57051	57019	57251	57219
3 x 250	2,5	57052	57020	57252	57220
	5	57053	57021	57253	57221
	10	57054	57022	57254	57222
3 x 300	2,5	57055	57023	57255	57223
	5	57056	57024	57256	57224
	10	57057	57025	57257	57225
3 x 300	15	57058	57026	57258	57226
	2,5	57059	57027	57259	57227
	5	57060	57028	57260	57228
3 x 400	10	57061	57029	57261	57229
	15	57062	57030	57262	57230
	2,5	57063	57031	57263	57231
3 x 500	5	57064	57032	57264	57232
	10	57065	57033	57265	57233
	15	57066	57034	57266	57234
3 x 600	2,5	57067	57035	57267	57235
	5	57068	57036	57268	57236
	10	57069	57037	57269	57237
3 x 600	15	57070	57038	57270	57238
	2,5	57071	57039	57271	57239
	5	57072	57040	57272	57240
3 x 750	10	57073	57041	57273	57241
	15	57074	57042	57274	57242

		Best.-Nr.
	Schnappbefestigung	-
	Plombierplatte Form B	59041

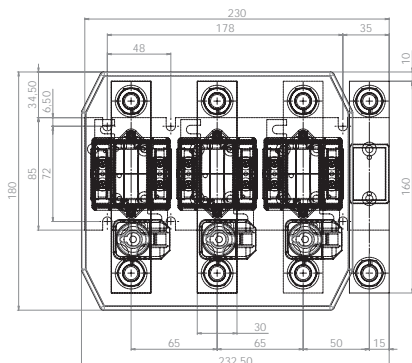
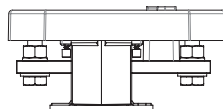
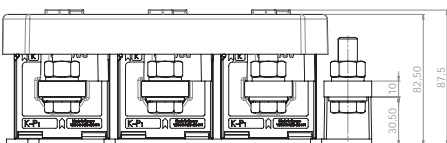



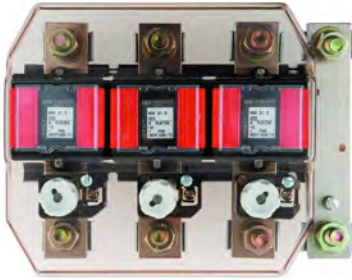

ASK(D) 31.5 2U

Dreiphasen-Stromwandlersatz,
sekundär umschaltbar



Primärstrom [A]	Bürde [VA]	Sekundärstrom [A] / Klasse			
		5 A Kl. 1 Best.-Nr.	5 A Kl. 0,5 Best.-Nr.	1 A Kl. 1 Best.-Nr.	1 A Kl. 0,5 Best.-Nr.
3 x 200-100	5-2,5	57090	57080	57290	57280
	10-5	57091	57081	57291	57281
3 x 300-150	5-2,5	57092	57082	57292	57282
	10-5	57093	57083	57293	57283
3 x 400-200	5-2,5	57094	57084	57294	57284
	10-5	57095	57085	57295	57285
3 x 500-250	5-2,5	57096	57086	57296	57286
	10-5	57097	57087	57297	57287
3 x 600-300	5-2,5	57098	57088	57298	57288
	10-5	57099	57089	57299	57289

		Best.-Nr.
	Schnappbefestigung	–
	Plombierplatte Form B	59041

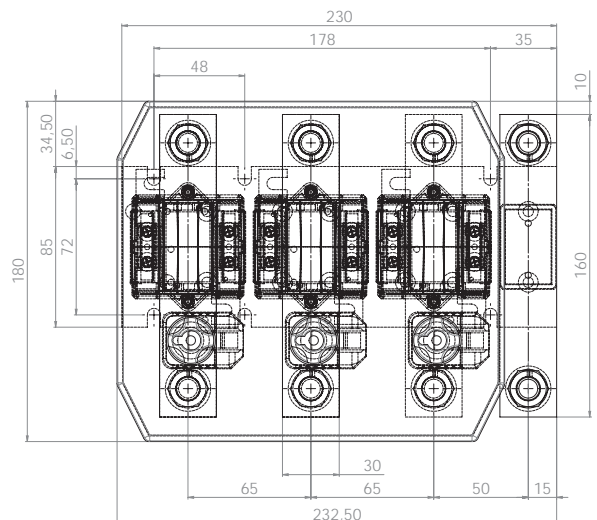
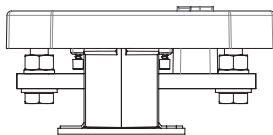
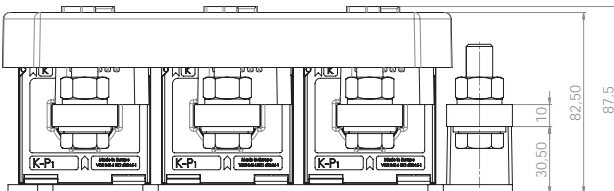





Dreiphasen-Stromwandler-Satz

WSKD 31.8

ASKD 31.8

mit Abdeckkappen aus Plexiglas

Ausführung:

Der Messwandlersatz der Typenreihe WSKD 31.8/ASKD 31.8 entspricht in seiner technischen Ausführung den Anforderungen der nachfolgend aufgeführten Normen:

- IEC 61869/1+2
- DIN 42600

Der Stromwandlersatz besteht aus drei baugleichen in einem Gehäuse angeordneten Einzelstromwandlern, welche gemeinsam mit einer Nullleiterschiene auf einer metallischen Grundplatte aus Aluminium montiert sind. Die Typenreihe WSKD 31.8 wird als Wickel-Stromwandler mit drei festen Primärwicklungen für primäre Nennströme bis 150 A gefertigt.

Für primäre Nennströme ab 200 A erfolgt die Auslieferung mit Primärstromschienen unter der Typenbezeichnung ASKD 31.8.

Der Messwandlersatz kann wahlweise mit bzw. ohne Sicherung geliefert werden. Der Spannungsabgriff vom Primärleiter erfolgt optional über 10 A-NEOZED Sicherungselemente oder über direkt auf die Stromschienen montierte Spannungsabgriffklemmen.

Durch direkt in die Sekundäranschlussklemmen eingebrachte 4-mm-Bohrungen wird ein einfaches Kurzschließen des Sekundärkreises während eines Zähleraustausches ermöglicht. Der Messwandlersatz ist mit bzw. ohne metallische Bodenplatte lieferbar (ohne Bodenplatte keine Nullleiter-Schiene). Alle spannungsführenden Teile des Messwandlersatzes sind nach erfolgter Montage durch eine im Lieferumfang enthaltene Isolierabdeckung gegen Berührung geschützt.

Allgemeine technische Angaben:

Maximal zulässige Betriebsspannung:	0,72 kV
Bemessungsfrequenz:	50 Hz
Überstrom-Begrenzungsfaktor:	FS 5
Therm. Bemessungs-Dauerstromstärke:	$1,2 \times I_N$
Therm. Bemessungs-Kurzzeitstrom:	$50 \times I_N$ (WSKD 31.8)
	$60 \times I_N$ (ASKD 31.8)
Isolierstoffklasse:	E



WSKD 31.8 mit Bodenplatte

Dreiphasen-Stromwandlersatz

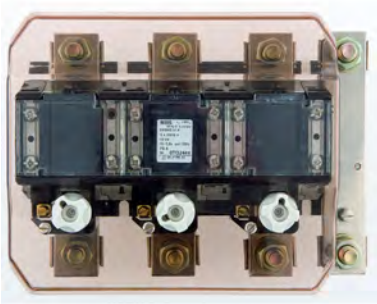

Primärstrom [A]	Bürde [VA]	Sekundärstrom [A] / Klasse			
		5 A Kl. 1 Best.-Nr.	5 A Kl. 0,5 Best.-Nr.	1 A Kl. 1 Best.-Nr.	1 A Kl. 0,5 Best.-Nr.
3 x 50	2,5	44030	44011	44230	44211
	5	44031	44012	44231	44212
	10	44032	44013	44232	44213
3 x 75	2,5	44034	44015	44234	44215
	5	44035	44016	44235	44216
	10	44036	44017	44236	44217
3 x 100	2,5	44038	44019	44238	44219
	5	44039	44020	44239	44220
	10	44040	44021	44240	44221
3 x 150	2,5	44042	44023	44242	44223
	5	44043	44024	44243	44224
	10	44044	44025	44244	44225

		Best.-Nr.
	Schnappbefestigung	-
	Plombierplatte	-

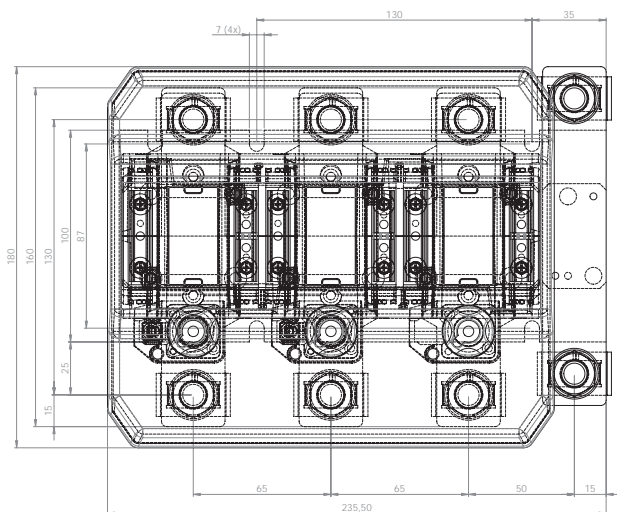
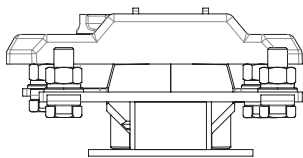
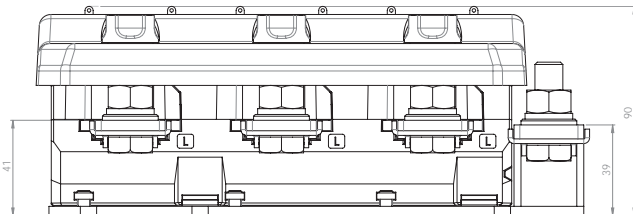

ASR

ASG

AS / ASK

WSK

KBR / KBU

KSU / SUSK

NH

SASK

ASRD

WSKD

CTB

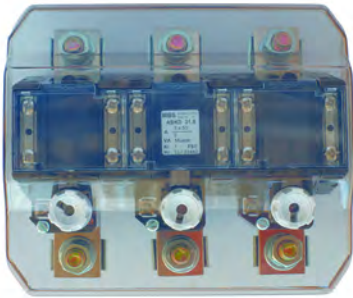

WSKD 31.8 ohne Bodenplatte und Nullleiter

Dreiphasen-Stromwandlersatz

Primärstrom [A]	Bürde [VA]	Sekundärstrom [A] / Klasse			
		5 A Kl. 1 Best.-Nr.	5 A Kl. 0,5 Best.-Nr.	1 A Kl. 1 Best.-Nr.	1 A Kl. 0,5 Best.-Nr.
3 x 50	2,5	45030	45011	45230	45211
	5	45031	45012	45231	45212
	10	45032	45013	45232	45213
3 x 75	2,5	45034	45015	45234	45215
	5	45035	45016	45235	45216
	10	45036	45017	45236	45217
3 x 100	2,5	45038	45019	45238	45219
	5	45039	45020	45239	45220
	10	45040	45021	45240	45221
3 x 150	2,5	45042	45023	45242	45223
	5	45043	45024	45243	45224
	10	45044	45025	45244	45225

		Best.-Nr.
	Schnappbefestigung	–
	Plombierplatte	–

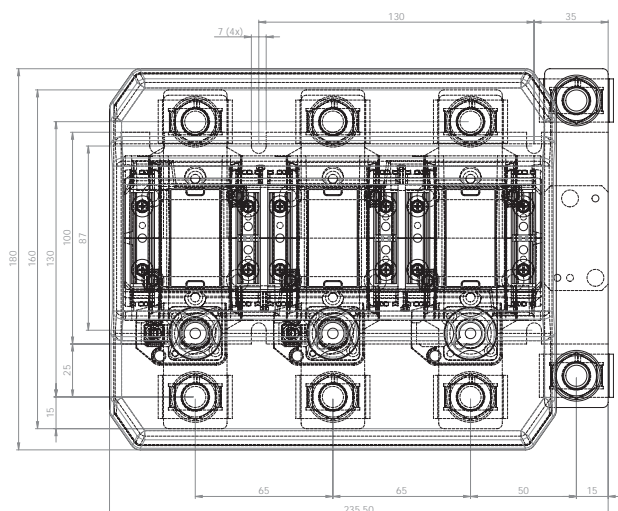
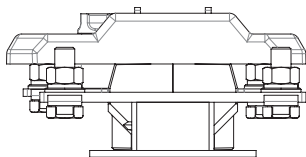
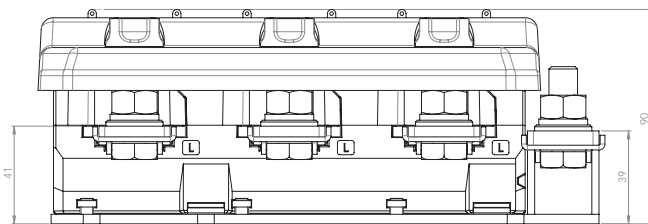



ASKD 31.8 mit Bodenplatte

Dreiphasen-Stromwandlersatz

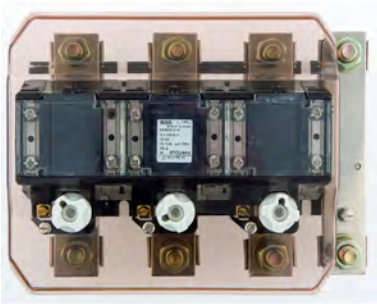

Primärstrom [A]	Bürde [VA]	Sekundärstrom [A] / Klasse			
		5 A Kl. 1 Best.-Nr.	5 A Kl. 0,5 Best.-Nr.	1 A Kl. 1 Best.-Nr.	1 A Kl. 0,5 Best.-Nr.
3 x 200	2,5	46041	46011	46241	46211
	5	46042	46012	46242	46212
	10	46043	46013	46243	46213
3 x 250	2,5	46045	46015	46245	46215
	5	46046	46016	46246	46216
	10	46047	46017	46247	46217
3 x 300	2,5	46049	46019	46249	46219
	5	46050	46020	46250	46220
	10	46051	46021	46251	46221
3 x 400	15	46052	46022	46252	46222
	2,5	46053	46023	46253	46223
	5	46054	46024	46254	46224
3 x 500	10	46055	46025	46255	46225
	15	46056	46026	46256	46226
	2,5	46058	46028	46258	46228
3 x 600	5	46059	46029	46259	46229
	10	46060	46030	46260	46230
	15	46061	46031	46261	46231
3 x 600	2,5	46063	46033	46263	46233
	5	46064	46034	46264	46234
	10	46065	46035	46265	46235
	15	46066	46036	46266	46236

		Best.-Nr.
	Schnappbefestigung	-
	Plombierplatte	-

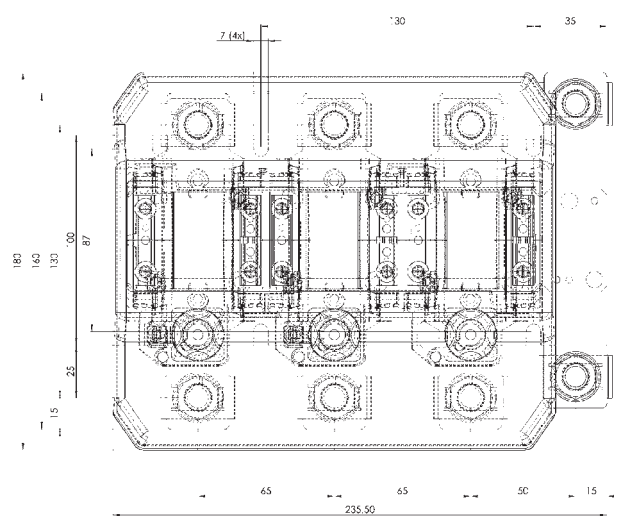
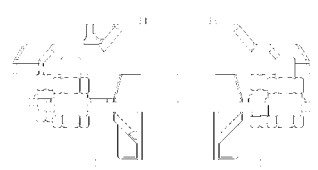
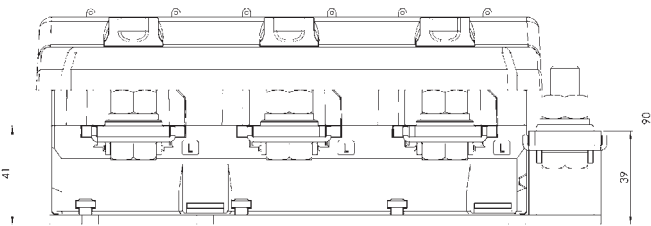

ASR
ASG
AS / ASK
WSK
KBR / KBU
KSU / SUJK
NH
SASK
ASRD
WSKD/ASKD
CTB



ASKD 31.8 ohne Bodenplatte und Nullleiter

Dreiphasen-Stromwandlersatz

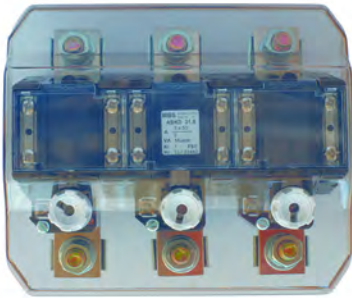

Primärstrom [A]	Bürde [VA]	Sekundärstrom [A] / Klasse			
		5 A Kl. 1 Best.-Nr.	5 A Kl. 0,5 Best.-Nr.	1 A Kl. 1 Best.-Nr.	1 A Kl. 0,5 Best.-Nr.
3 x 200	2,5	47041	47011	47241	47211
	5	47042	47012	47242	47212
	10	47043	47013	47243	47213
3 x 250	2,5	47045	47015	47245	47215
	5	47046	47016	47246	47216
	10	47047	47017	47247	47217
3 x 300	2,5	47049	47019	47249	47219
	5	47050	47020	47250	47220
	10	47051	47021	47251	47221
	15	47052	47022	47252	47222
3 x 400	2,5	47053	47023	47253	47223
	5	47054	47024	47254	47224
	10	47055	47025	47255	47225
	15	47056	47026	47256	47226
3 x 500	2,5	47058	47028	47258	47228
	5	47059	47029	47259	47229
	10	47060	47030	47260	47230
	15	47061	47031	47261	47231
3 x 600	2,5	47063	47033	47263	47233
	5	47064	47034	47264	47234
	10	47065	47035	47265	47235
	15	47066	47036	47266	47236

		Best.-Nr.
	Schnappbefestigung	–
	Plombierplatte	–

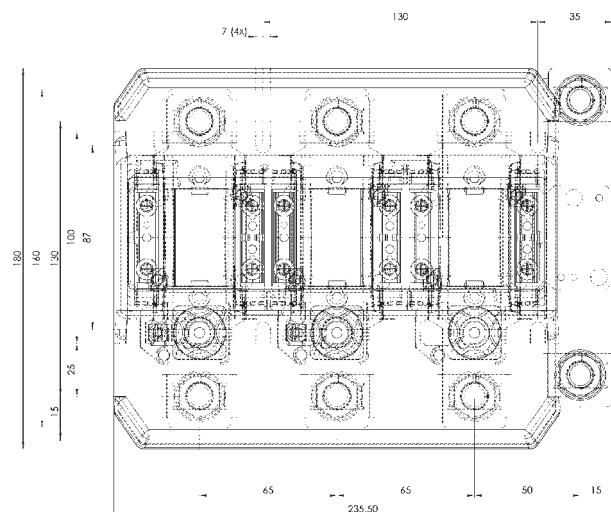
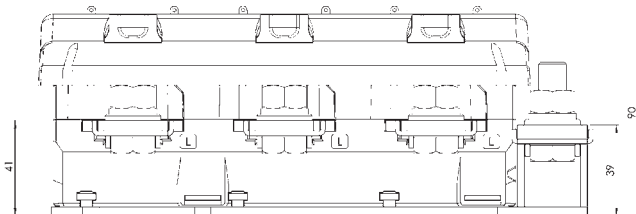





MBS AG





Aufsteck-Stromwandler mit schraubenloser Anschluss technik

„Cage Clamp®“, UL-zertifiziert

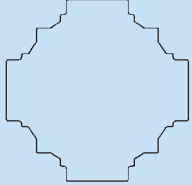
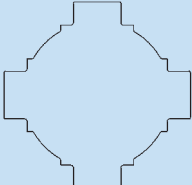
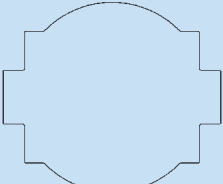
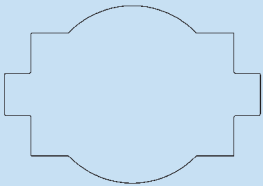
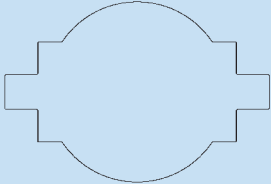
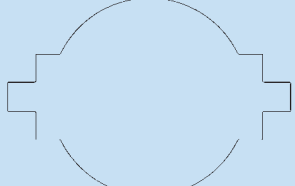
CTB 31.35	Primärleiter		30 x 10 mm
	Rundleiter Wandlerbreite		25 x 12 mm 20 x 20 mm 25,7 mm 60 mm
CTB 41.35	Primärleiter		40 x 10 mm
	Rundleiter Wandlerbreite		30 x 15 mm 31,8 mm 70 mm
CTB 51.35	Primärleiter		50 x 12 mm
	Rundleiter Wandlerbreite		40 x 30 mm 43,7 mm 85 mm
CTB 61.35	Primärleiter		63 x 10 mm
	Rundleiter Wandlerbreite		50 x 30 mm 43,7 mm 95 mm
CTB 81.35	Primärleiter		80 x 10 mm
	Rundleiter Wandlerbreite		60 x 30 mm 54,7 mm 120 mm
CTB 101.35	Primärleiter		100 x 10 mm
	Rundleiter Wandlerbreite		80 x 30 mm 70 mm 130 mm



MBS AG



CTB 31.35

Aufsteck-Stromwandler



Schiene 1	30 x 10 mm
Schiene 2	25 x 12 mm
Schiene 3	20 x 20 mm
Rundleiter	25,7 mm
Baubreite	60 mm
Bauhöhe	80,9 mm
Bautiefe gesamt	52 mm

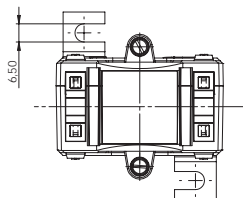
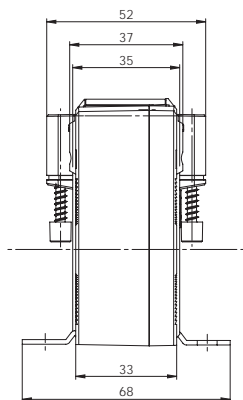
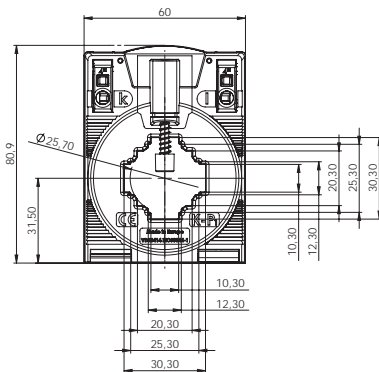

Primärstrom [A]	Bürde [VA]	Sekundärstrom [A] / Klasse					
		5 A Kl. 3 Best.-Nr.	5 A Kl. 1 Best.-Nr.	5 A Kl. 0,5 Best.-Nr.	1 A Kl. 3 Best.-Nr.	1 A Kl. 1 Best.-Nr.	1 A Kl. 0,5 Best.-Nr.
50	1,25	50-0001			50-0021		
60	1,25		50-0017			50-0037	
75	2,5		50-0018			50-0038	
80	2,5		50-0019			50-0039	
100	2,5		50-0002			50-0022	
125	1,5			50-2001			50-2021
	2,5		50-0003			50-0023	
150	2,5			50-2002			50-2022
	5		50-0004			50-0024	
200	2,5			50-2003			50-2023
	5		50-0005			50-0025	
250	5		50-0006	50-2004		50-0026	50-2024
	10		50-0007	50-2005		50-0027	50-2025
300	5		50-0008			50-0028	
	10		50-0009	50-2006		50-0029	50-2026
400	5		50-0010	50-2007		50-0030	50-2027
	10		50-0011	50-2008		50-0031	50-2028
500	5		50-0012	50-2009		50-0032	50-2029
	10		50-0013	50-2010		50-0033	50-2030
600	5		50-0014	50-2011		50-0034	50-2031
	10		50-0015	50-2012		50-0035	50-2032
750	5		50-0016	50-2013		50-0036	50-2033
	10						

	Best.-Nr.
	Schnappbefestigung CTB 55015
	Quick-Fix Schnellbefestigung 55021
	Plombierplatte Form G 59057

- UL zertifiziert; Zertifikatsnummer: 20100426-E336996
- Weltweit erster Stromwandler mit schraubenloser Anschlussstechnik – Federzugklemme „Cage Clamp“[®]
- Innovative, zeitsparende Anschlussmöglichkeit (Front oder Top) für massive und flexible Leiter (max. 4 mm² – Aderendhülsen können entfallen)
- Schockfest und rüttelsicher, hohe mechanische Haltekräfte
- Wartungsfreie, gasdichte Verbindung
- Hohe Stromfestigkeit
- Therm. Nenndauerstrom I_{cth} : 1,2 x I_N
- Niederspannungs-Stromwandler für max. Betriebsspannungen bis 1,2 kV; Einsatz in 690 V Netzen möglich

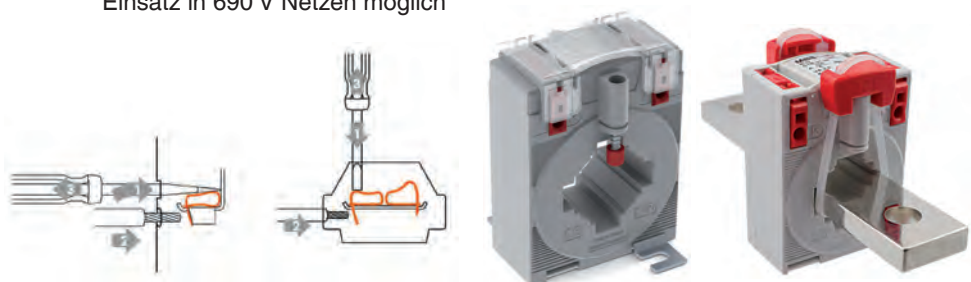



CTB 41.35

Aufsteck-Stromwandler



Schiene 1	40 x 10 mm
Schiene 2	30 x 15 mm
Rundleiter	31,8 mm
Baubreite	70 mm
Bauhöhe	91,15 mm
Bautiefe gesamt	52 mm

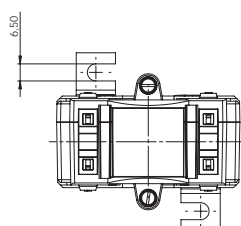
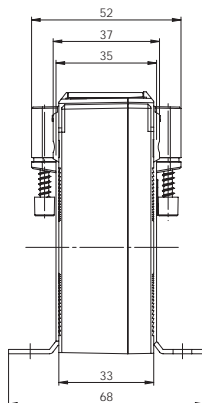
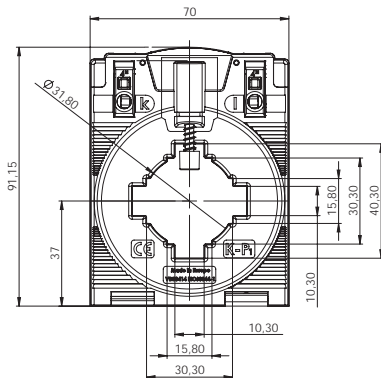

Primärstrom [A]	Bürde [VA]	Sekundärstrom [A] / Klasse					
		5 A Kl. 3 Best.-Nr.	5 A Kl. 1 Best.-Nr.	5 A Kl. 0,5 Best.-Nr.	1 A Kl. 3 Best.-Nr.	1 A Kl. 1 Best.-Nr.	1 A Kl. 0,5 Best.-Nr.
75	1,25	50-0050			50-0070		
80	1,25	50-0051			50-0071		
100	2,5	50-0052			50-0072		
125	2,5		50-0053			50-0073	
150	2,5		50-0054			50-0074	
200	1,5			50-2050			50-2070
	5		50-0055			50-0075	
250	2,5			50-2051			50-2071
	5		50-0056			50-0076	
300	2,5			50-2052			
	5		50-0057			50-0077	50-2072
400	5		50-0058	50-2053		50-0078	50-2073
500	5		50-0059	50-2054		50-0079	50-2074
	10		50-0060			50-0080	50-2075
600	5		50-0061	50-2055		50-0081	50-2076
	10		50-0062	50-2056		50-0082	50-2077
750	5		50-0063	50-2057		50-0083	50-2078
	10		50-0064	50-2058		50-0084	
800	5		50-0065	50-2059		50-0085	50-2079
	10		50-0066	50-2060		50-0086	50-2080
1000	5		50-0067	50-2061		50-0087	50-2081
	10		50-0068	50-2062		50-0088	50-2082

	Best.-Nr.
	Schnappbefestigung CTB 55015
	Quick-Fix Schnellbefestigung 55021
	Plombierplatte Form G 59057

- UL zertifiziert; Zertifikatsnummer: 20100426-E336996
- Weltweit erster Stromwandler mit schraubenloser Anschlussstechnik – Federzugklemme „Cage Clamp“[®]
- Innovative, zeitsparende Anschlussmöglichkeit (Front oder Top) für massive und flexible Leiter (max. 4 mm² – Aderendhülsen können entfallen)
- Schockfest und rüttelsicher, hohe mechanische Haltekräfte
- Wartungsfreie, gasdichte Verbindung
- Hohe Stromfestigkeit
- Therm. Nenndauerstrom I_{cth} : $1,2 \times I_N$
- Niederspannungs-Stromwandler für max. Betriebsspannungen bis 1,2 kV; Einsatz in 690 V Netzen möglich

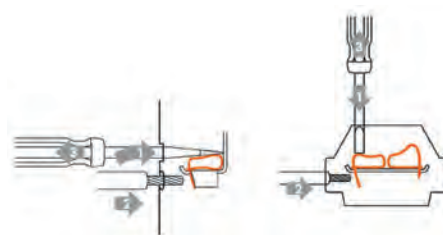



MBS AG



CTB 51.35

Aufsteck-Stromwandler



Schiene 1	50 x 12 mm
Schiene 2	40 x 30 mm
Rundleiter	43,7 mm
Baubreite	85 mm
Bauhöhe	105,25 mm
Bautiefe gesamt	52 mm

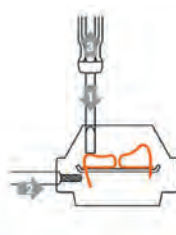
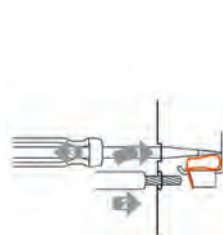
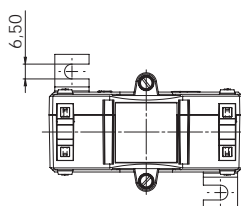
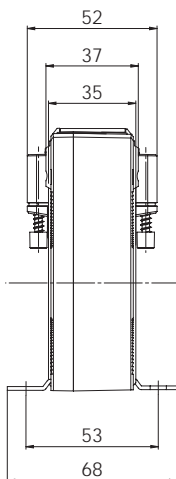
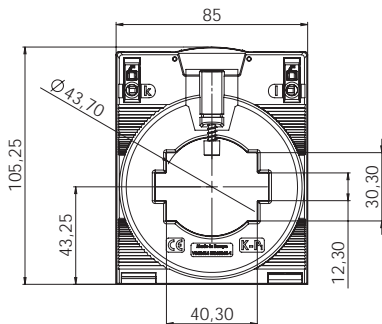

Primärstrom [A]	Bürde [VA]	Sekundärstrom [A] / Klasse			
		5 A Kl. 1 Best.-Nr.	5 A Kl. 0,5 Best.-Nr.	1 A Kl. 1 Best.-Nr.	1 A Kl. 0,5 Best.-Nr.
100	1,25	50-0100		50-0120	
125	2,5	50-0101		50-0121	
150	2,5	50-0102		50-0122	
200	1,5		50-2100		50-2120
	5	50-0103		50-0123	
250	2,5		50-2101		50-2121
	5	50-0104		50-0124	
300	2,5		50-2102		50-2122
	5	50-0105		50-0125	
400	5	50-0106	50-2103	50-0126	50-2123
	10	50-0107		50-0127	
500	5	50-0108	50-2104	50-0128	50-2124
	10	50-0109	50-2105	50-0129	50-2125
600	5	50-0110	50-2106	50-0130	50-2126
	10	50-0111	50-2107	50-0131	50-2127
750	5	50-0112	50-2108	50-0132	50-2128
	10	50-0113	50-2109	50-0133	50-2129
800	5	50-0114	50-2110	50-0134	50-2130
	10	50-0115	50-2111	50-0135	50-2131
1000	5	50-0116	50-2112	50-0136	50-2132
	10	50-0117	50-2113	50-0137	50-2133
1200	5	50-0291	50-2114	50-0293	50-2134
	10	50-0292	50-2115	50-0294	50-2140
1250	5	50-0118	50-2116	50-0138	50-2136
	10	50-0119	50-2117	50-0139	50-2137

	Best.-Nr.
	Quick-Fix Schnellbefestigung 55021
	Plombierplatte Form H 59058

- UL zertifiziert; Zertifikatsnummer: 20100426-E336996
- Weltweit erster Stromwandler mit schraubenloser Anschlussstechnik – Federzugklemme „Cage Clamp“[®]
- Innovative, zeitsparende Anschlussmöglichkeit (Front oder Top) für massive und flexible Leiter (max. 4 mm² – Aderendhülsen können entfallen)
- Schockfest und rüttelsicher, hohe mechanische Haltekräfte
- Wartungsfreie, gasdichte Verbindung
- Hohe Stromfestigkeit
- Therm. Nenndauerstrom I_{ctn} : 1,2 x I_N
- Niederspannungs-Stromwandler für max. Betriebsspannungen bis 1,2 kV; Einsatz in 690 V Netzen möglich



MBS AG



CTB 61.35

Aufsteck-Stromwandler



Schiene 1	63 x 10 mm
Schiene 2	50 x 30 mm
Rundleiter	43,7 mm
Baubreite	95 mm
Bauhöhe	114,86 mm
Bautiefe gesamt	52 mm

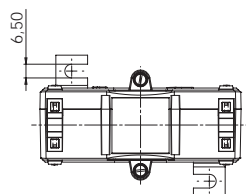
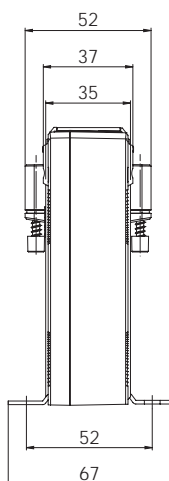
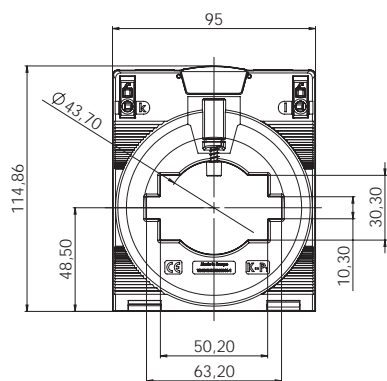

Primärstrom [A]	Bürde [VA]	Sekundärstrom [A] / Klasse			
		5 A Kl. 1 Best.-Nr.	5 A Kl. 0,5 Best.-Nr.	1 A Kl. 1 Best.-Nr.	1 A Kl. 0,5 Best.-Nr.
200	2,5	50-0150	50-2150	50-0170	50-2170
250	2,5		50-2151		50-2171
	5	50-0151		50-0171	
300	5	50-0152	50-2152	50-0172	50-2172
400	5	50-0153	50-2153	50-0173	50-2173
500	5	50-0154	50-2154	50-0174	50-2174
600	5	50-0155	50-2155	50-0175	50-2175
750	5	50-0156	50-2156	50-0176	50-2176
	10	50-0157	50-2157	50-0177	50-2177
800	5	50-0158	50-2158	50-0178	50-2178
	10	50-0159	50-2159	50-0179	50-2179
1000	5	50-0160	50-2160	50-0180	50-2180
	10	50-0161	50-2161	50-0181	50-2181
1200	5	50-0287	50-2162	50-0289	50-2182
	10	50-0288	50-2163	50-0290	50-2183
1250	5	50-0162	50-2164	50-0182	50-2184
	10	50-0163	50-2165	50-0183	50-2185
1500	5	50-0164	50-2166	50-0184	50-2186
	10	50-0165	50-2167	50-0185	50-2187
1600	5	50-0166	50-2168	50-0186	50-2188
	10	50-0167	50-2169	50-0187	50-2189

	Best.-Nr.
	55021
	59059

- UL zertifiziert; Zertifikatsnummer: 20100426-E336996
- Weltweit erster Stromwandler mit schraubenloser Anschlussstechnik – Federzugklemme „Cage Clamp“[®]
- Innovative, zeitsparende Anschlussmöglichkeit (Front oder Top) für massive und flexible Leiter (max. 4 mm² – Aderendhülsen können entfallen)
- Schockfest und rüttelsicher, hohe mechanische Haltekräfte
- Wartungsfreie, gasdichte Verbindung
- Hohe Stromfestigkeit
- Therm. Nenndauerstrom I_{cth} : $1,2 \times I_N$
- Niederspannungs-Stromwandler für max. Betriebsspannungen bis 1,2 kV; Einsatz in 690 V Netzen möglich

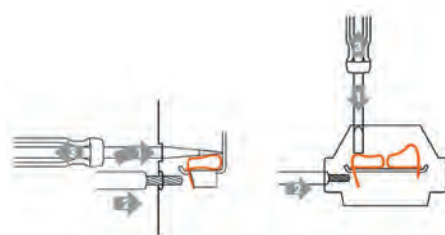



CTB 81.35

Aufsteck-Stromwandler



- Schiene 1 80 x 10 mm
- Schiene 2 60 x 30 mm
- Rundleiter 54,7 mm
- Baubreite 120 mm
- Bauhöhe 134,66 mm
- Bautiefe gesamt 52 mm

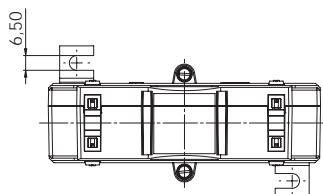
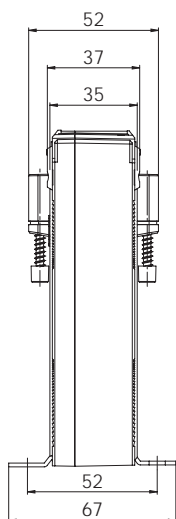
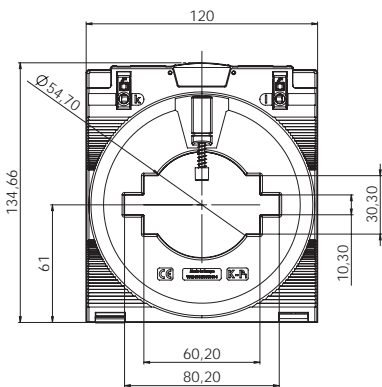

Primärstrom [A]	Bürde [VA]	Sekundärstrom [A] / Klasse			
		5 A Kl. 1 Best.-Nr.	5 A Kl. 0,5 Best.-Nr.	1 A Kl. 1 Best.-Nr.	1 A Kl. 0,5 Best.-Nr.
400	2,5		50-2190		50-2210
	5	50-0190		50-0210	
500	2,5		50-2191		
	5	50-0191		50-0211	50-2211
600	5	50-0192	50-2192	50-0212	50-2212
750	5	50-0193	50-2193	50-0213	50-2213
	10	50-0194	50-2194	50-0214	50-2214
800	5	50-0195	50-2195	50-0215	50-2215
	10	50-0196	50-2196	50-0216	50-2216
1000	5	50-0197	50-2197	50-0217	50-2217
	10	50-0198	50-2198	50-0218	50-2218
1200	5	50-0283	50-2199	50-0285	50-2219
	10	50-0284	50-2200	50-0286	50-2220
1250	5	50-0199	50-2201	50-0219	50-2221
	10	50-0200	50-2202	50-0220	50-2222
1500	5	50-0201	50-2203	50-0221	50-2223
	10	50-0202	50-2204	50-0222	50-2224
1600	5	50-0203	50-2205	50-0223	50-2225
	10	50-0204	50-2206	50-0224	50-2226
2000	10	50-0205	50-2207	50-0225	50-2227
	15	50-0206	50-2208	50-0226	50-2228

		Best.-Nr.
	Quick-Fix Schnellbefestigung	55021
	Plombierplatte Form J	59059

- UL zertifiziert; Zertifikatsnummer: 20100426-E336996
- Weltweit erster Stromwandler mit schraubenloser Anschluss technik – Federzugklemme „Cage Clamp“
- Innovative, zeitsparende Anschlussmöglichkeit (Front oder Top) für massive und flexible Leiter (max. 4 mm² – Aderendhülsen können entfallen)
- Schockfest und rüttelsicher, hohe mechanische Haltekräfte
- Wartungsfreie, gasdichte Verbindung
- Hohe Stromfestigkeit
- Therm. Nenndauerstrom I_{ctH}: 1,2 x I_N
- Niederspannungs-Stromwandler für max. Betriebsspannungen bis 1,2 kV; Einsatz in 690 V Netzen möglich

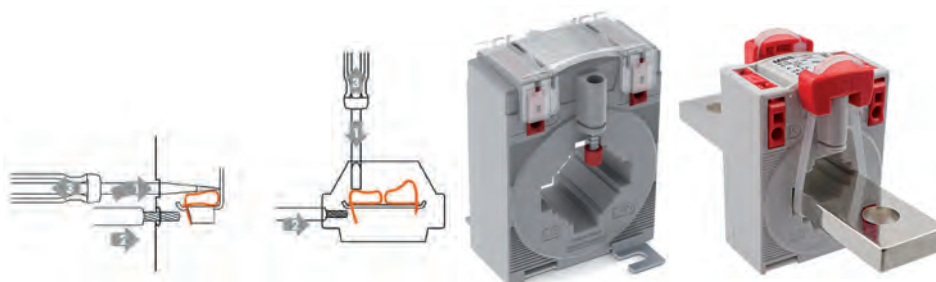



MBS AG



CTB 101.35

Aufsteck-Stromwandler



Schiene 1	100 x 10 mm
Schiene 2	80 x 30 mm
Rundleiter	70 mm
Baubreite	130 mm
Bauhöhe	147,49 mm
Bautiefe gesamt	52 mm

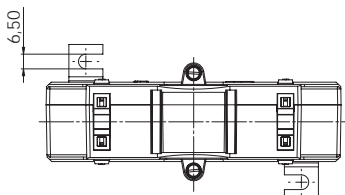
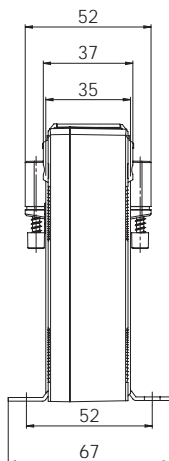
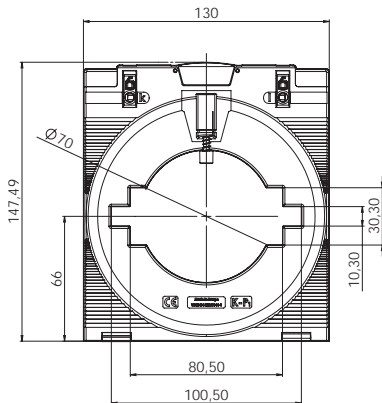

Primärstrom [A]	Bürde [VA]	Sekundärstrom [A] / Klasse			
		5 A Kl. 1 Best.-Nr.	5 A Kl. 0,5 Best.-Nr.	1 A Kl. 1 Best.-Nr.	1 A Kl. 0,5 Best.-Nr.
400	2,5		50-2230		50-2260
	5	50-0230		50-0260	
500	5	50-0231	50-2231	50-0261	50-2261
	10		50-2232		50-2262
600	5			50-0262	
	10	50-0232			
750	5	50-0233	50-2233	50-0263	50-2263
	10	50-0234	50-2234	50-0264	50-2264
800	5	50-0235	50-2235	50-0265	50-2265
	10	50-0236	50-2236	50-0266	50-2266
1000	5	50-0237	50-2237	50-0267	50-2267
	10	50-0238	50-2238	50-0268	50-2268
1200	5	50-0279	50-2239	50-0281	50-2269
	10	50-0280	50-2240	50-0282	50-2270
1250	5	50-0239	50-2241	50-0269	50-2271
	10	50-0240	50-2242	50-0270	50-2272
1500	10	50-0241	50-2243	50-0271	50-2273
	15	50-0242	50-2244	50-0272	50-2274
1600	10	50-0243	50-2245	50-0273	50-2275
	15	50-0244	50-2246	50-0274	50-2276
2000	10	50-0245	50-2247	50-0275	50-2277
	15	50-0246	50-2248	50-0276	50-2278
2500	10	50-0247	50-2249	50-0277	50-2279
	15	50-0248	50-2250	50-0278	50-2280

		Best.-Nr.
	Quick-Fix Schnellbefestigung	55021
	Plombierplatte Form J	59059

- UL zertifiziert; Zertifikatsnummer: 20100426-E336996
- Weltweit erster Stromwandler mit schraubenloser Anschlussstechnik – Federzugklemme „Cage Clamp“[®]
- Innovative, zeitsparende Anschlussmöglichkeit (Front oder Top) für massive und flexible Leiter (max. 4 mm² – Aderendhülsen können entfallen)
- Schockfest und rüttelsicher, hohe mechanische Haltekräfte
- Wartungsfreie, gasdichte Verbindung
- Hohe Stromfestigkeit
- Therm. Nenndauerstrom $I_{cth} : 1,2 \times I_N$
- Niederspannungs-Stromwandler für max. Betriebsspannungen bis 1,2 kV; Einsatz in 690 V Netzen möglich

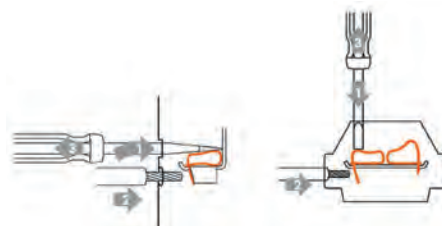







Niederspannungs-Stromwandler für Verrechnung

Rohrstab-Stromwandler

EASR 14.3	Rundleiter		Ø 14 mm
	Wandlerbreite		45 mm
EASR 22.3	Rundleiter		Ø 22,5 mm
	Wandlerbreite		61 mm

Aufsteck-Stromwandler

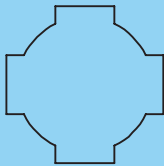
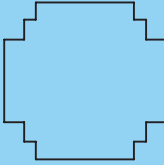
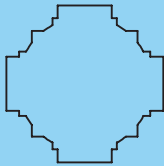
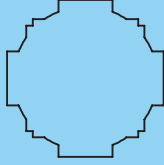
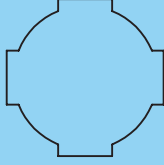
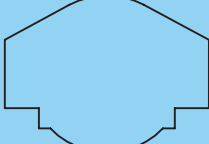
EAS 176.3	Primärleiter		17 x 6 mm
	Rundleiter		Ø 15,2 mm
EASK 176.3	Wandlerbreite		44 mm
EASK 21.3	Primärleiter		20 x 10 mm
	Rundleiter		Ø 19,2 mm
	Wandlerbreite		61 mm
EASK 31.3	Primärleiter		30 x 10 mm
	Rundleiter		2 x 20 x 10 mm
	Wandlerbreite		Ø 26 mm
			61 mm
EASK 31.4	Primärleiter		30 x 10 mm
	Rundleiter		2 x 20 x 10 mm
	Wandlerbreite		Ø 28 mm
			61 mm
EASK 31.5	Primärleiter		30 x 10 mm
	Rundleiter		2 x 20 x 10 mm
	Wandlerbreite		Ø 28 mm
EASK 31.5 2U			61 mm
EASK 31.6	Primärleiter		30 x 10 mm
	Rundleiter		20 x 13 mm
	Wandlerbreite		Ø 23 mm
			95 mm

Type „E“ bedeutet, dass die Stromwandler zu Eichzwecken geeignet sind.



EASR 14.3

Rohrstab-Stromwandler – Verrechnung



Stromwandler geeignet zum integrierten Einbau in die SlimLine-Schaltleisten der Größe XR00.

Rundleiter 14 mm
 Baubreite 45 mm
 Bauhöhe 65 mm
 Bautiefe gesamt 30 mm

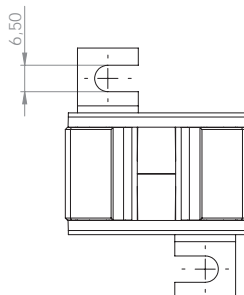
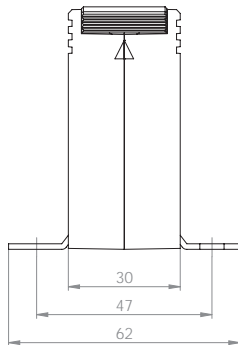
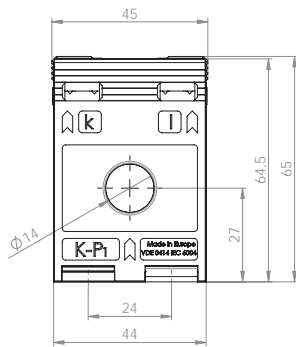

Primärstrom [A]	Bürde [VA]	Sekundärstrom [A] / Klasse				
		5 A Kl. 0,5 Best.-Nr.	5 A Kl. 0,5s Best.-Nr.	5 A Kl. 0,2 Best.-Nr.	1 A Kl. 0,5 Best.-Nr.	1 A Kl. 0,2 Best.-Nr.
75	1,5	26584	26590		26770	
80	1,5	26585	26591		26771	
100	1,5	26586	26592	26568	26786	26777
120	1,5	26587	26593	26563	26772	26778
	2,5	26588	26594		26773	
125	1,5	26599	26595	26564	26774	26779
	2,5	26560	26597		26775	
150	1,5	26561	26598	26566	26776	26780
	2,5	26589	26596	26567	26789	26781

		Best.-Nr.
	Schnappbefestigung Form E	55013
	Plombierplatte	–



EASR 22.3

Rohrstab-Stromwandler – Verrechnung



Rundleiter 22,5 mm
 Baubreite 61 mm
 Bauhöhe 78,5 mm
 Bautiefe gesamt 35 mm

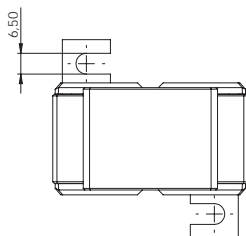
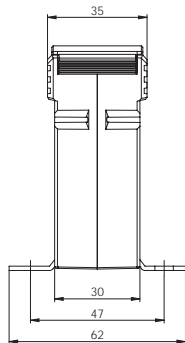
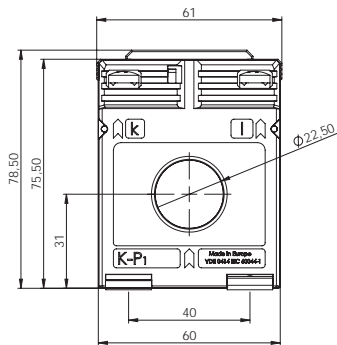

Primärstrom [A]	Bürde [VA]	Sekundärstrom [A] / Klasse				
		5 A Kl. 0,5 Best.-Nr.	5 A Kl. 0,5s Best.-Nr.	5 A Kl. 0,2 Best.-Nr.	1 A Kl. 0,5 Best.-Nr.	1 A Kl. 0,2 Best.-Nr.
100	1,5	3530	3552	3511	3730	3711
	2,5	3531	3553		3731	
150	1,5	3532	3554	3512	3732	3712
	2,5	3533	3555	3513	3733	3713
	5	3534	3556		3734	
200	1,5	3535	3557	3514	3735	3714
	2,5	3536	3558	3515	3736	3715
	5	3537	3559	3516	3737	3716
250	2,5	3538	3560	3517	3738	3717
	5	3539	3561	3518	3739	3718
300	2,5	3540	3562	3519	3740	3719
	5	3541	3563	3520	3741	3720
	10	3542	3564			
400	2,5	3543	3565	3521	3743	3721
	5	3544	3566	3522	3744	3722
	10	3545	3567	3523	3745	3723
500	2,5	3546	3568	3524	3746	3724
	5	3547	3569	3525	3747	3725
	10	3548	3570	3526	3748	3726
600	2,5	3549	3571	3527	3749	3727
	5	3550	3572	3528	3750	3728
	10	3551	3573	3529	3751	3729

		Best.-Nr.
	Schnappbefestigung Form A	53011
	Plombierplatte Form A	59040

EASR

EASK

EWSK /
ESUSKEASKD /
EWSKD



EAS 176.3

Aufsteck-Stromwandler – Verrechnung



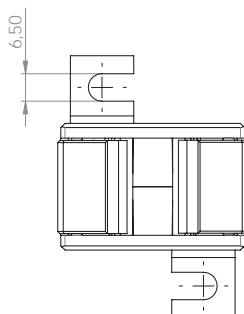
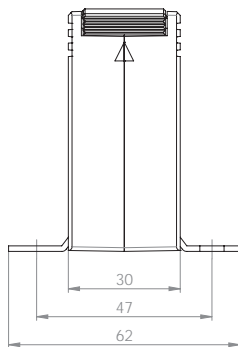
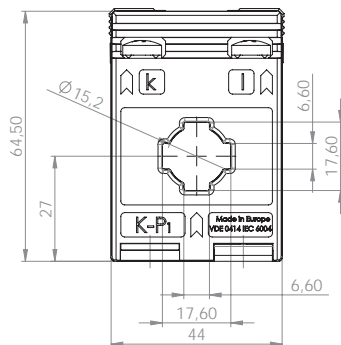

Stromwandler geeignet zum integrierten Einbau in die SlimLine-Schaltleisten der Größe XR1.

Schiene 1	17 x 6 mm
Rundleiter	15,2 mm
Baubreite	44 mm
Bauhöhe	65 mm
Bautiefe gesamt	30 mm



Primärstrom [A]	Bürde [VA]	Sekundärstrom [A] / Klasse	
		5 A Kl. 0,5 Best.-Nr.	1 A Kl. 0,5 Best.-Nr.
100	1,5	1030505004	1030705004
150	1,5	1030505001	1030705001
	2,5	1030505005	1030705005
200	2,5	1030505002	1030705002
250	2,5	1030505003	1030705003

		Best.-Nr.
	Schnappbefestigung Form E	55013
	Plombierplatte	–



EASK 176.3

Aufsteck-Stromwandler – Verrechnung



Schiene 1 17 x 6 mm
 Rundleiter 15,2 mm
 Baubreite 44 mm
 Bauhöhe 65 mm
 Bautiefe gesamt 46 mm

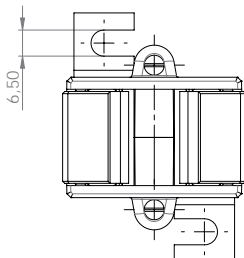
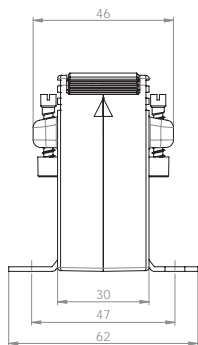
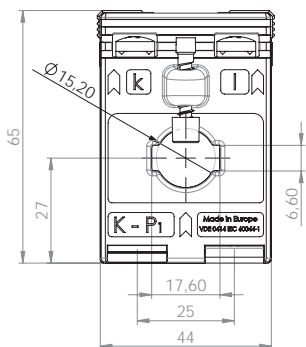

Primärstrom [A]	Bürde [VA]	Sekundärstrom [A] / Klasse	
		5 A Kl. 0,5 Best.-Nr.	1 A Kl. 0,5 Best.-Nr.
100	1,5	1020505004	1020705004
150	1,5	1020505001	1020705001
	2,5	1020505005	1020705005
200	2,5	1020505002	1020705002
250	2,5	1020505003	1020705003

		Best.-Nr.
	Schnappbefestigung Form E	55013
	Plombierplatte	-

EASR

EAS/EASK

EWSK /
ESUSK

EASKD /
EWSKD



EASK 21.3

Aufsteck-Stromwandler – Verrechnung



Schiene 1	20 x 10 mm
Rundleiter	19,2 mm
Baubreite	61 mm
Bauhöhe	78,5 mm
Bautiefe gesamt	48 mm

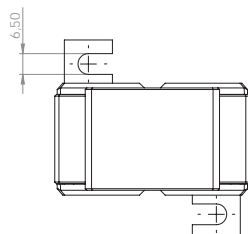
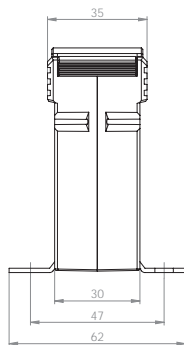
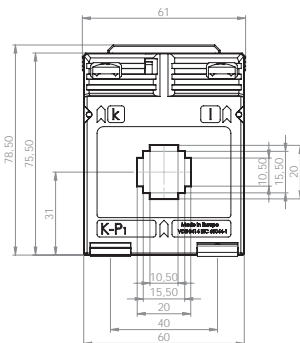

Primärstrom [A]	Bürde [VA]	Sekundärstrom [A] / Klasse				
		5 A Kl. 0,5 Best.-Nr.	5 A Kl. 0,5s Best.-Nr.	5 A Kl. 0,2 Best.-Nr.	1 A Kl. 0,5 Best.-Nr.	1 A Kl. 0,2 Best.-Nr.
100	1,5	6530	6549	6511	6730	6711
	2,5	6531	6550		6731	
150	1,5	6532	6551	6513	6732	6713
	2,5	6533	6552	6514	6733	6714
	5	6534	6553		6734	
200	1,5	6535	6554	6516	6735	6716
	2,5	6536	6555	6517	6736	6717
	5	6537	6556	6518	6737	6718
250	2,5	6538	6557	6519	6738	6719
	5	6539	6558	6520	6739	6720
300	2,5	6540	6559	6521	6740	6721
	5	6541	6560	6522	6741	6722
	10	6542	6561			
400	2,5	6543	6562	6524	6743	6724
	5	6544	6563	6525	6744	6725
	10	6545	6564	6526	6745	6726
500	2,5	6546	6565	6527	6746	6727
	5	6547	6566	6528	6747	6728
	10	6548	6567	6529	6748	6729

		Best.-Nr.
	Schnappbefestigung Form A	53011
	Plombierplatte Form A	59040



EASK 31.3

Aufsteck-Stromwandler – Verrechnung



- Schiene 1 30 x 10 mm
- Schiene 2 2 x 20 x 10 mm
- Rundleiter 26 mm
- Baubreite 61 mm
- Bauhöhe 78,5 mm
- Bautiefe gesamt 48 mm

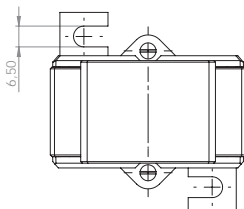
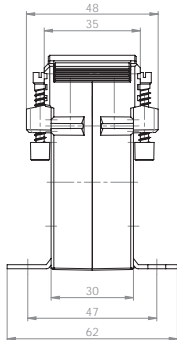
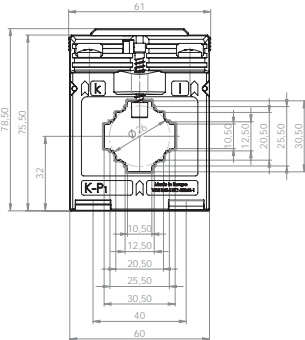

Primärstrom [A]	Bürde [VA]	Sekundärstrom [A] / Klasse				
		5 A Kl. 0,5 Best.-Nr.	5 A Kl. 0,5s Best.-Nr.	5 A Kl. 0,2 Best.-Nr.	1 A Kl. 0,5 Best.-Nr.	1 A Kl. 0,2 Best.-Nr.
100	1,5	7533	7555		7733	7711
	2,5	7534	7556		7734	
150	1,5	7535	7557	7513	7735	7713
	2,5	7536	7558		7736	
200	2,5	7537	7559	7515	7737	7715
	5	7538	7560	7516	7738	7716
250	2,5	7539	7561	7517	7739	7717
	5	7540	7562	7518	7740	7718
300	2,5	7541	7563	7519	7741	7719
	5	7542	7564	7520	7742	7720
400	2,5	7543	7565	7521	7743	7721
	5	7544	7566	7522	7744	7722
500	2,5	7546	7568	7524	7746	7724
	5	7547	7569	7525	7747	7725
600	2,5	7549	7571	7527	7749	7727
	5	7550	7572	7528	7750	7728
750	2,5	7552	7574	7530	7752	7730
	5	7553	7575	7531	7753	7731

		Best.-Nr.
	Schnappbefestigung Form A	53011
	Plombierplatte Form A	59040

EASR

EASK

EWSK /
ESUSK

EASKD /
EWSKD



EASK 31.4

Aufsteck-Stromwandler – Verrechnung



Schiene 1	30 x 10 mm
Schiene 2	2 x 20 x 10 mm
Rundleiter	28 mm
Baubreite	61 mm
Bauhöhe	78,5 mm
Bautiefe gesamt	58 mm

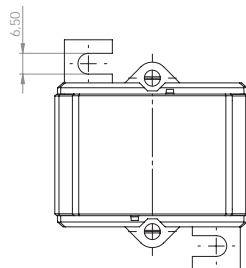
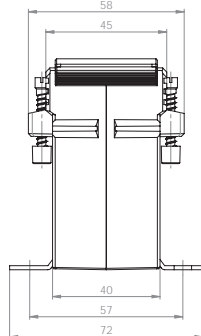
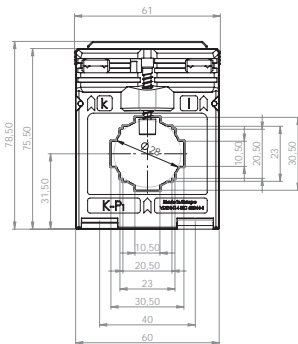

Primärstrom [A]	Bürde [VA]	Sekundärstrom [A] / Klasse				
		5 A Kl. 0,5 Best.-Nr.	5 A Kl. 0,5s Best.-Nr.	5 A Kl. 0,2 Best.-Nr.	1 A Kl. 0,5 Best.-Nr.	1 A Kl. 0,2 Best.-Nr.
100	1,5			8510		
	2,5	8535	8559	8511	8735	8711
150	2,5	8536	8560	8512	8736	8712
	5	8537	8561		8737	
200	2,5	8538	8562	8514	8738	8714
	5	8539	8563	8515	8739	8715
250	2,5	8540	8564	8516	8740	8716
	5	8541	8565	8517	8741	8717
300	2,5	8542	8566	8518	8742	8718
	5	8543	8567	8519	8743	8719
	10	8544	8568	8520	8744	8720
400	2,5	8545	8569	8521	8745	8721
	5	8546	8570	8522	8746	8722
	10	8547	8571	8523	8747	8723
500	2,5	8548	8572	8524	8748	8724
	5	8549	8573	8525	8749	8725
	10	8550	8574	8526	8750	8726
600	2,5	8551	8575	8527	8751	8727
	5	8552	8576	8528	8752	8728
	10	8553	8577	8529	8753	8729
750	15	8554	8578		8754	
	2,5	8555	8579	8531	8755	8731
	5	8556	8580	8532	8756	8732
	10	8557	8581	8533	8757	8733
	15	8558	8582		8758	

		Best.-Nr.
	Schnappbefestigung Form B	54011
	Plombierplatte Form B	59041



EASK 31.5

Aufsteck-Stromwandler – Verrechnung



Schiene 1	30 x 10 mm
Schiene 2	2 x 20 x 10 mm
Rundleiter	28 mm
Baubreite	61 mm
Bauhöhe	78,5 mm
Bautiefe gesamt	68 mm

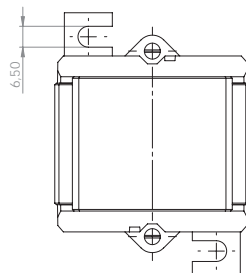
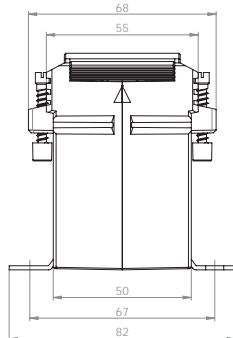
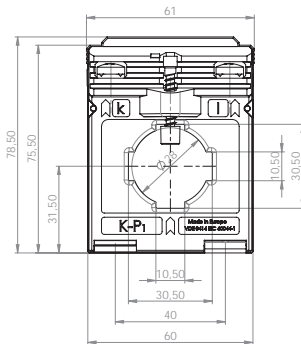

Primärstrom [A]	Bürde [VA]	Sekundärstrom [A] / Klasse			
		5 A Kl. 0,5 Best.-Nr.	5 A Kl. 0,5s Best.-Nr.	5 A Kl. 0,2 Best.-Nr.	5 A Kl. 0,2s Best.-Nr.
75	2,5	9542	9574		
100	2,5	9543	9575	9511	
	5	9544			
150	2,5	9545	9577	9513	
	5	9546	9578		
200	2,5	9547	9579	9515	V17-1704D
	5	9548	9580	9516	V17-1704F
	10	9549	9581		
250	2,5	9550	9582	9518	V17-1804D
	5	9551	9583	9519	V17-1804F
	10	9552	9584	9520	
	15	9553	9585		
300	2,5	9554	9586	9522	V17-1904D
	5	9555	9587	9523	V17-1904F
	10	9556	9588	9524	
	15	9557	9589		
400	2,5	9558	9590	9526	V17-2004D
	5	9559	9591	9527	V17-2004F
	10	9560	9592	9528	V17-2004H
	15	9561	9593		
500	2,5	9562	9594	9530	V17-2104D
	5	9563	9595	9531	V17-2104F
	10	9564	9596	9532	V17-2104H
	15	9565	9597		
600	2,5	9566	9598	9534	V17-2204D
	5	9567	9599	9535	V17-2204F
	10	9568	9600	9536	V17-2204H
	15	9569	9601		
750	5	9571	9603	9539	V17-2304F
	10	9572	9604	9540	V17-2304H
	15	9573	9605		

		Best.-Nr.
	Schnappbefestigung Form C	55011
	Plombierplatte Form B	59041



EASK 31.5

Aufsteck-Stromwandler – Verrechnung



Schiene 1	30 x 10 mm
Schiene 2	2 x 20 x 10 mm
Rundleiter	28 mm
Baubreite	61 mm
Bauhöhe	78,5 mm
Bautiefe gesamt	68 mm

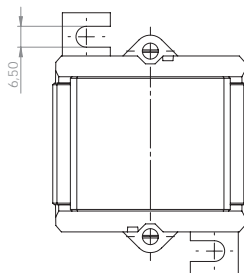
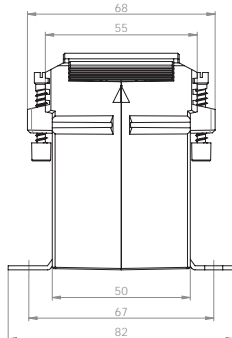
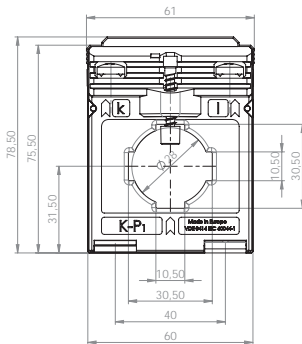

Primärstrom [A]	Bürde [VA]	Sekundärstrom [A] / Klasse	
		1 A Kl. 0,5 Best.-Nr.	1 A Kl. 0,2 Best.-Nr.
75	2,5	9742	
100	2,5	9743	9711
	5	9744	
150	2,5	9745	9713
	5	9746	
200	2,5	9747	9715
	5	9748	9716
	10	9749	
250	2,5	9750	9718
	5	9751	9719
	10	9752	9720
	15	9753	
300	2,5	9754	9722
	5	9755	9723
	10	9756	9724
	15	9757	
400	2,5	9758	9726
	5	9759	9727
	10	9760	9728
	15	9761	
500	2,5	9762	9730
	5	9763	9731
	10	9764	9732
	15	9765	
600	2,5	9766	9734
	5	9767	9735
	10	9768	9736
	15	9769	
750	5	9771	9739
	10	9772	9740
	15	9773	

		Best.-Nr.
	Schnappbefestigung Form C	55011
	Plombierplatte Form B	59041



EASK 31.5 2U

Aufsteck-Stromwandler, sekundär umschaltbar –
Verrechnung



Schiene 1	30 x 10 mm
Schiene 2	2 x 20 x 10 mm
Rundleiter	28 mm
Baubreite	61 mm
Bauhöhe	78,5 mm
Bautiefe gesamt	68 mm

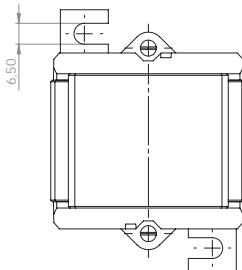
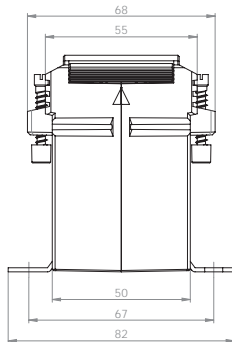
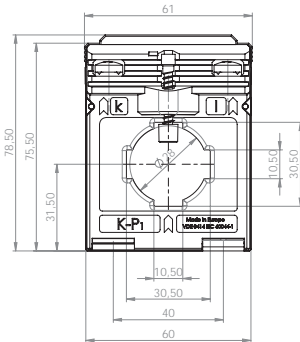

Primärstrom [A]	Bürde [VA]	Sekundärstrom [A] / Klasse	
		5 A Kl. 0,5s Best.-Nr.	5 A Kl. 0,5 Best.-Nr.
200-100	5-2,5	9616	9606
300-150	5-2,5	9618	9608
	10-5	9619	9609
400-200	5-2,5	9620	9610
	10-5	9621	9611
500-250	5-2,5	9622	9612
	10-5	9623	9613
600-300	5-2,5	9624	9614
	10-5	9625	9615
200-100	10-5		9607

		Best.-Nr.
	Schnappbefestigung Form C	55011
	Plombierplatte Form B	59041



EASK 31.6

Aufsteck-Stromwandler – Verrechnung



Schiene 1	30 x 10 mm
Schiene 2	20 x 13 mm
Rundleiter	23 mm
Baubreite	95 mm
Bauhöhe	116 mm
Bautiefe gesamt	74 mm

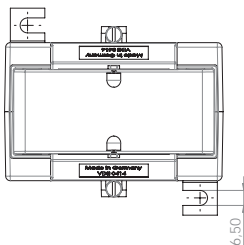
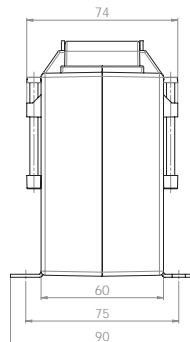
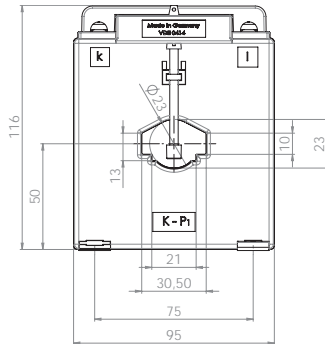

Primärstrom [A]	Bürde [VA]	Sekundärstrom [A] / Klasse				
		5 A Kl. 0,5 Best.-Nr.	5 A Kl. 0,5s Best.-Nr.	5 A Kl. 0,2 Best.-Nr.	1 A Kl. 0,5 Best.-Nr.	1 A Kl. 0,2 Best.-Nr.
50	2,5	10547	10585		10747	
75	2,5	10548	10586		10748	
	5	10549			10749	
100	2,5	10550	10588	10513	10750	10713
	5	10551	10589		10751	
	10	10552	10590		10752	
150	2,5	10553	10591	10516	10753	10716
	5	10554	10592	10517	10754	10717
	10	10555	10593		10755	
	15	10556	10594		10756	
200	5	10557	10595	10521	10757	10721
	10	10558	10596	10522	10758	10722
	15	10559	10597		10759	
250	5	10560	10598	10524	10760	10724
	10	10561	10599	10525	10761	10725
	15	10563	10600		10763	
300	5	10565	10602	10528	10765	10728
	10	10566	10603	10529	10766	10729
	15	10567	10604		10767	
	30	10568	10605		10768	
400	5	10569	10606	10532	10769	10732
	10	10570	10607	10533	10770	10733
	15	10571	10608	10534	10771	10734
	30	10572	10609		10772	
500	5	10573	10610	10536	10773	10736
	10	10574	10611	10537	10774	10737
	15	10575	10612	10538	10775	10738
	30	10576	10613		10776	
600	5	10577	10614	10540	10777	10740
	10	10578	10615	10541	10778	10741
	15	10579	10616	10542	10779	10742
	30	10580	10617		10780	
750	5	10581	10618	10543	10781	10743
	10	10582	10619	10544	10782	10744
	15	10583	10620	10545	10783	10745
	30	10584	10621		10784	

		Best.-Nr.
	Schnappbefestigung	–
	Plombierplatte Form E	59044

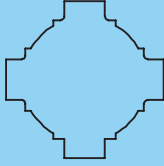
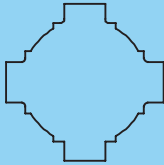
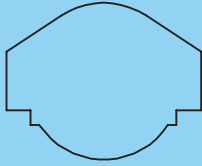
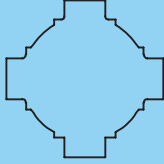
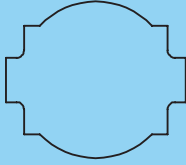
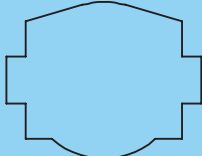

Stromwandler für Verrechnung

EASK 41.4 EASK 41.4 2U	Primärleiter		40 x 10 mm
	Rundleiter Wandlerbreite		2 x 30 x 5 mm Ø 32 mm 71 mm
EASK 41.5	Primärleiter		40 x 10 mm
	Rundleiter Wandlerbreite		2 x 30 x 5 mm Ø 32 mm 71 mm
EASK 41.6	Primärleiter		40 x 12 mm
	Rundleiter Wandlerbreite		30 x 15 mm Ø 32 mm 95 mm
EASK 541.4	Primärleiter		40 x 10 mm
	Rundleiter Wandlerbreite		2 x 30 x 5 mm Ø 32 mm 86 mm
EASK 51.4 EASK 51.4 2U	Primärleiter		50 x 12 mm
	Rundleiter Wandlerbreite		2 x 40 x 10 mm Ø 44 mm 86 mm
EASK 51.6	Primärleiter		50 x 12 mm
	Rundleiter Wandlerbreite		40 x 30 mm Ø 40 mm 95 mm

Type „E“ bedeutet, dass die Stromwandler zu Eichzwecken geeignet sind.



EASK 41.4

Aufsteck-Stromwandler – Verrechnung



Schiene 1	40 x 10 mm
Schiene 2	2 x 30 x 5 mm
Rundleiter	32 mm
Baubreite	71 mm
Bauhöhe	88,5 mm
Bautiefe gesamt	58 mm

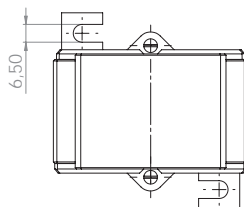
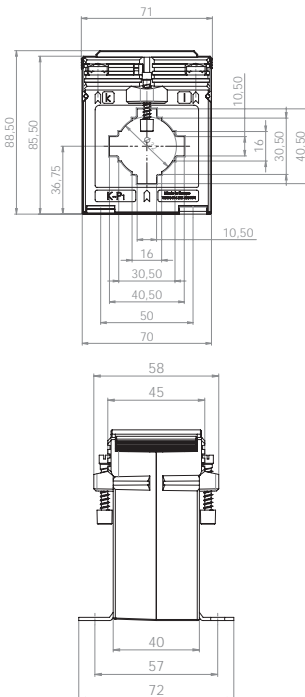

Primärstrom [A]	Bürde [VA]	Sekundärstrom [A] / Klasse				
		5 A Kl. 0,5 Best.-Nr.	5 A Kl. 0,5s Best.-Nr.	5 A Kl. 0,2 Best.-Nr.	1 A Kl. 0,5 Best.-Nr.	1 A Kl. 0,2 Best.-Nr.
100	1,5	13540	13569	13511	13740	13711
	2,5	13541	13570		13741	
150	1,5	13542	13571	13513	13742	13713
	2,5	13543	13572	13514	13743	13714
	5	13544	13573		13744	
200	1,5	13545	13574	13516	13745	13716
	2,5	13546	13575	13517	13746	13717
	5	13548	13576	13518	13747	13718
250	2,5	13549	13578	13520	13749	13720
	5	13550	13579	13521	13750	13721
300	2,5	13551	13580	13522	13751	13722
	5	13552	13581	13523	13752	13723
	10	13553	13582		13753	
400	2,5	13554	13583	13525	13754	13725
	5	13555	13584	13526	13755	13726
	10	13556	13585	13527	13756	13727
500	2,5	13557	13586	13528	13757	13728
	5	13558	13587	13529	13758	13729
	10	13559	13588	13530	13759	13730
	15	13560	13589	13531	13760	13731
600	2,5	13561	13590	13532	13761	13732
	5	13562	13591	13533	13762	13733
	10	13563	13592	13534	13763	13734
750	15	13564	13593	13535	13764	13735
	2,5	13565	13594	13536	13765	13736
	5	13566	13595	13537	13766	13737
	10	13567	13596	13538	13767	13738
	15	13568	13597		13768	13739

		Best.-Nr.
	Schnappbefestigung Form D	55012
	Plombierplatte Form B	59041



EASK 41.4 2U

Aufsteck-Stromwandler, sekundär umschaltbar – Verrechnung



- Schiene 1 40 x 10 mm
- Schiene 2 2 x 30 x 5 mm
- Rundleiter 32 mm
- Baubreite 71 mm
- Bauhöhe 88,5 mm
- Bautiefe gesamt 58 mm

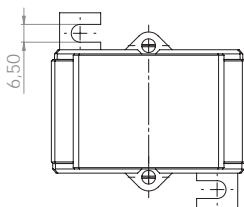
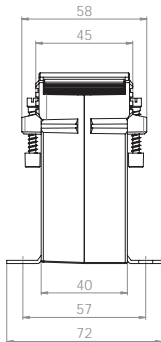
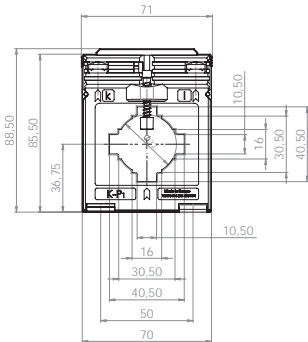

Primärstrom [A]	Bürde [VA]	Sekundärstrom [A] / Klasse	
		5 A Kl. 0,5 Best.-Nr.	5 A Kl. 0,5s Best.-Nr.
200-100	5-2,5	13598	13607
300-150	5-2,5	13599	13608
	10-5	13600	13609
400-200	5-2,5	13601	13610
	10-5	13602	13611
500-250	5-2,5	13603	13612
	10-5	13604	13613
600-300	5-2,5	13605	13614
	10-5	13606	13615

		Best.-Nr.
	Schnappbefestigung Form D	55012
	Plombierplatte Form B	59041

EASR

EASK

EWSK /
ESUSK

EASKD /
EWSKD



MBS AG



EASK 41.5

Aufsteck-Stromwandler – Verrechnung



Schiene 1	40 x 10 mm
Schiene 2	2 x 30 x 5 mm
Rundleiter	32 mm
Baubreite	71 mm
Bauhöhe	88,5 mm
Bautiefe gesamt	68 mm

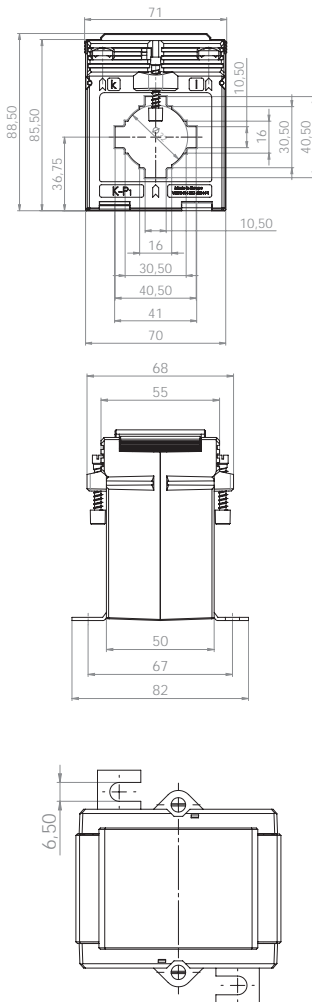

Primärstrom [A]	Bürde [VA]	Sekundärstrom [A] / Klasse				
		5 A Kl. 0,5 Best.-Nr.	5 A Kl. 0,5s Best.-Nr.	5 A Kl. 0,2 Best.-Nr.	1 A Kl. 0,5 Best.-Nr.	1 A Kl. 0,2 Best.-Nr.
75	2,5	1010505001			1010705001	
80	2,5	1010505002			1010705002	
100	1,5	1010505003	1010504001		1010705003	
	2,5	1010505004	1010504002		1010705004	
150	2,5	1010505005	1010504003	1010503002	1010705005	1010703003
	5	1010505006	1010504004		1010705006	
200	2,5	1010505007	1010504005	1010503003	1010705007	1010703005
	5	1010505008	1010504006	1010503004	1010705008	1010703006
250	2,5	1010505009	1010504007	1010503005	1010705010	1010703007
	5	1010505010	1010504008	1010503006	1010705011	1010703008
	10	1010505011	1010504009		1010705012	
300	2,5	1010505012	1010504010	1010503008	1010705013	1010703009
	5	1010505013	1010504011	1010503009	1010705014	1010703010
	10	1010505014	1010504012	1010503010	1010705015	1010703011
400	15	1010505015	1010504013		1010705016	
	2,5	1010505016	1010504014	1010503011	1010705017	1010703012
	5	1010505017	1010504015	1010503012	1010705018	1010703013
	10	1010505018	1010504016	1010503013	1010705019	1010703014
500	15	1010505019	1010504017		1010705020	
	2,5	1010505020	1010504018	1010503014	1010705021	1010703015
	5	1010505021	1010504019	1010503015	1010705022	1010703016
	10	1010505022	1010504020	1010503016	1010705023	1010703017
600	15	1010505023	1010504021		1010705024	
	2,5	1010505024	1010504022	1010503017	1010705025	1010703018
	5	1010505025	1010504023	1010503018	1010705026	1010703019
	10	1010505026	1010504024	1010503019	1010705027	1010703020
750	15	1010505027	1010504025		1010705028	
	2,5	1010505028	1010504026	1010503021	1010705029	1010703022
	5	1010505029	1010504027	1010503022	1010705030	1010703023
	10	1010505030	1010504028	1010503023	1010705031	1010703024
800	15	1010505031	1010504029		1010705032	
	2,5	1010505032	1010504030	1010503025	1010705033	1010703026
	5	1010505033	1010504031	1010503026	1010705034	1010703027
	10	1010505034	1010504032	1010503027	1010705035	1010703028
1000	15	1010505035	1010504033		1010705036	
	2,5	1010505036	1010504034	1010503029	1010705037	1010703030
	5	1010505037	1010504035	1010503030	1010705038	1010703031
	10	1010505038	1010504036	1010503031	1010705039	1010703032
	15	1010505039	1010504037		1010705040	

		Best.-Nr.
	Schnappbefestigung Form C	55011
	Plombierplatte Form B	59041



EASK 41.6

Aufsteck-Stromwandler – Verrechnung



Schiene 1	40 x 12 mm
Schiene 2	30 x 15 mm
Rundleiter	32 mm
Baubreite	95 mm
Bauhöhe	116 mm
Bautiefe gesamt	74 mm

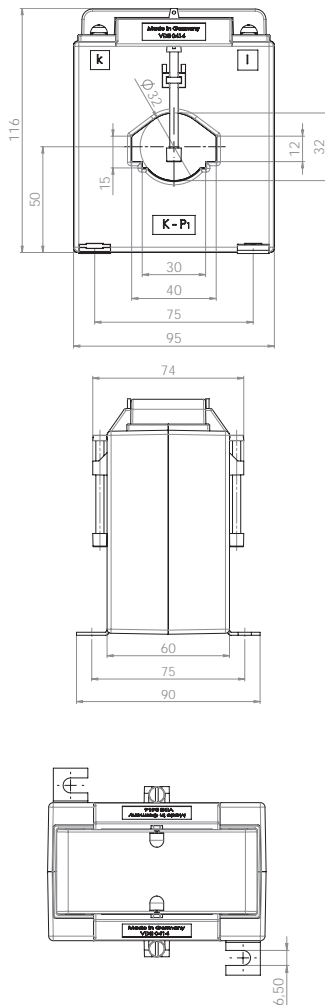

Primärstrom [A]	Bürde [VA]	Sekundärstrom [A] / Klasse				
		5 A Kl. 0,5 Best.-Nr.	5 A Kl. 0,5s Best.-Nr.	5 A Kl. 0,2 Best.-Nr.	1 A Kl. 0,5 Best.-Nr.	1 A Kl. 0,2 Best.-Nr.
75	2,5	14552	14595		14752	
	5	14553			14753	
100	2,5	14554	14597	14513	14754	14713
	5	14555	14598		14755	
	10	14556			14756	
150	2,5	14557	14600	14516	14757	14716
	5	14558	14601	14517	14758	14717
	10	14559	14602		14759	
	15	14560	14603		14760	
200	2,5	14561	14604	14520	14761	14720
	5	14562	14605	14521	14762	14721
	10	14563	14606	14522	14763	14722
	15	14564	14607		14764	
250	2,5	14565	14608	14524	14765	14724
	5	14566	14609	14525	14766	14725
	10	14567	14610	14526	14767	14726
	15	14568	14611		14768	
300	2,5	14569	14612	14528	14769	14728
	5	14570	14613	14529	14770	14729
	10	14571	14614	14530	14771	14730
	15	14572	14615	14531	14772	14731
400	2,5	14573	14616	14532	14773	14732
	5	14574	14617	14533	14774	14733
	10	14575	14618	14534	14775	14734
500	15	14576	14619	14535	14776	14735
	2,5	14577	14620	14536	14777	14736
	5	14578	14621	14537	14778	14737
	10	14579	14622	14538	14779	14738
600	15	14580	14623	14539	14780	14739
	2,5	14581	14624	14540	14781	14740
	5	14582	14625	14541	14782	14741
	10	14583	14626	14542	14783	14742
	15	14584	14627	14543	14784	14743
750	30	14585	14628		14785	
	2,5	14586	14629	14544	14786	14744
	5	14587	14630	14545	14787	14745
	10	14588	14631	14546	14788	14746
	15	14589	14632	14547	14789	14747
1000	30	14590	14633		14790	
	5	14591	14634	14548	14791	14748
	10	14592	14635	14549	14792	14749
	15	14593	14636	14550	14793	14750
	30	14594	14637		14794	

		Best.-Nr.
	Schnappbefestigung	–
	Plombierplatte Form E	59044



EASK 541.4

Aufsteck-Stromwandler – Verrechnung



Schiene 1	40 x 10 mm
Schiene 2	2 x 30 x 5 mm
Rundleiter	32 mm
Baubreite	86 mm
Bauhöhe	101,5 mm
Bautiefe gesamt	58 mm

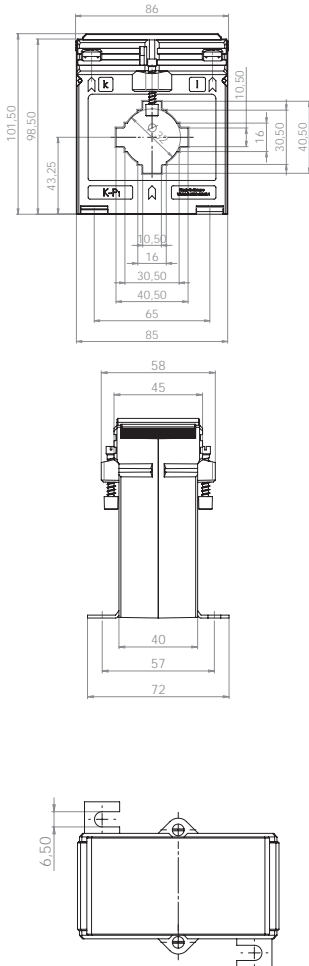

Primärstrom [A]	Bürde [VA]	Sekundärstrom [A] / Klasse				
		5 A Kl. 0,5 Best.-Nr.	5 A Kl. 0,5s Best.-Nr.	5 A Kl. 0,2 Best.-Nr.	1 A Kl. 0,5 Best.-Nr.	1 A Kl. 0,2 Best.-Nr.
75	1,5	15557	15603		15757	
	2,5	15558	15604		15758	
100	1,5	15559	15605	15513	15759	15713
	2,5	15560	15606	15514	15760	15714
	5	15561	15607		15761	
150	1,5	15562	15608	15516	15762	15716
	2,5	15563	15609	15517	15763	15717
	5	15564	15610	15518	15764	15718
	10	15565	15611		15765	
200	2,5	15566	15612	15520	15766	15720
	5	15567	15613	15521	15767	15721
	10	15568	15614	15522	15768	15722
	15	15569	15615		15769	
250	2,5	15570	15616	15524	15770	15724
	5	15571	15617	15525	15771	15725
	10	15572	15618	15526	15772	15726
	15	15573	15619		15773	
300	2,5	15574	15620	15528	15774	15728
	5	15575	15621	15529	15775	15729
	10	15576	15622	15530	15776	15730
	15	15577	15623	15531	15777	15731
400	2,5	15578	15624	15532	15778	15732
	5	15579	15625	15533	15779	15733
	10	15580	15626	15534	15780	15734
	15	15581	15627	15535	15781	15735
500	2,5	15583	15629	15537	15783	15737
	5	15584	15630	15538	15784	15738
	10	15585	15631	15539	15785	15739
	15	15586	15632	15540	15786	15740
600	2,5	15588	15634	15542	15788	15742
	5	15589	15635	15543	15789	15743
	10	15590	15636	15544	15790	15744
	15	15591	15637	15545	15791	15745
	30	15592			15792	
750	2,5	15593	15639	15547	15793	15747
	5	15594	15640	15548	15794	15748
	10	15595	15641	15549	15795	15749
	15	15596	15642	15550	15796	15750
	30	15597	15643		15797	
1000	2,5		15644	15552		
	5	15599	15645	15553	15799	15753
	10	15600	15646	15554	15800	15754
	15	15601	15647	15555	15801	15755
	30	15602	15648		15802	

		Best.-Nr.
	Schnappbefestigung	–
	Plombierplatte Form C	59042



EASK 51.4

Aufsteck-Stromwandler – Verrechnung



- Schiene 1 50 x 12 mm
- Schiene 2 2 x 40 x 10 mm
- Rundleiter 44 mm
- Baubreite 86 mm
- Bauhöhe 101,5 mm
- Bautiefe gesamt 58 mm

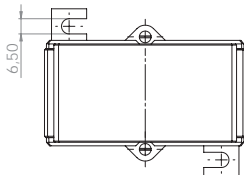
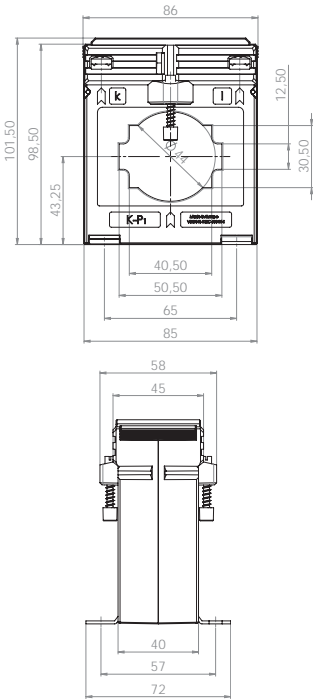

Primärstrom [A]	Bürde [VA]	Sekundärstrom [A] / Klasse				
		5 A Kl. 0,5 Best.-Nr.	5 A Kl. 0,5s Best.-Nr.	5 A Kl. 0,2 Best.-Nr.	1 A Kl. 0,5 Best.-Nr.	1 A Kl. 0,2 Best.-Nr.
100	1,5	16542	16573		16742	
	2,5	16543	16574		16743	
150	1,5	16544	16575	16513	16744	16713
	2,5	16545	16576		16745	
200	1,5	16546	16577	16515	16746	16715
	2,5	16547	16578	16516	16747	16716
	5	16548	16579	16517	16748	16717
250	1,5	16549	16580	16518	16749	16718
	2,5	16550	16581	16519	16750	16719
	5	16551	16582	16520	16751	16720
300	2,5	16553	16584	16522	16753	16722
	5	16554	16585	16523	16754	16723
400	2,5	16555	16586	16524	16755	16724
	5	16556	16587	16525	16756	16725
	10	16557	16588	16526	16757	16726
500	2,5	16558	16589	16527	16758	16727
	5	16559	16590	16528	16759	16728
600	10	16560	16591	16529	16760	16729
	2,5	16561	16592	16530	16761	16730
	5	16562	16593	16531	16762	16731
750	10	16563	16594	16532	16763	16732
	15	16564	16595	16533	16764	16733
	2,5	16565	16596	16534		16734
1000	5	16566	16597	16535	16766	16735
	10	16567	16598	16536	16767	16736
	15	16568	16599	16537	16768	16737
1000	5	16570	16601	16539	16770	16739
	10	16571	16602	16540	16771	16740
	15	16572	16603	16541	16772	16741

		Best.-Nr.
	Schnappbefestigung	-
	Plombierplatte Form C	59042

EASR

EASK

EWSK /
ESUSK

EASKD /
EWSKD



EASK 51.4 2U



Aufsteck-Stromwandler, sekundär umschaltbar –
Verrechnung

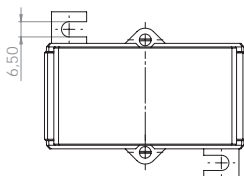
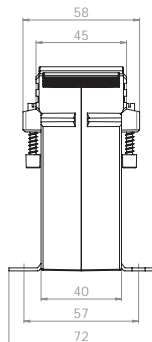
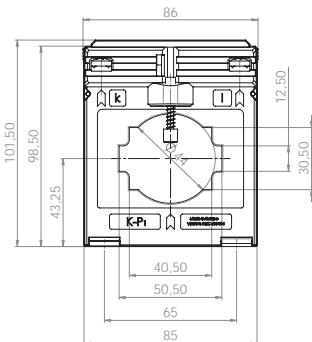

Schiene 1	50 x 12 mm
Schiene 2	2 x 40 x 10 mm
Rundleiter	44 mm
Baubreite	86 mm
Bauhöhe	101,5 mm
Bautiefe gesamt	58 mm



Primärstrom [A]	Bürde [VA]	Sekundärstrom [A] / Klasse	
		5 A Kl. 0,5 Best.-Nr.	5 A Kl. 0,5s Best.-Nr.
200-100	5-2,5	16611	16621
300-150	5-2,5	16612	16622
400-200	5-2,5	16613	16623
	10-5	16614	16624
500-250	5-2,5	16615	16625
	10-5	16616	16626
600-300	5-2,5	16617	16627
	10-5	16618	16628
1000-500	5-2,5	16619	16629
	10-5	16620	16630

		Best.-Nr.
	Schnappbefestigung	–
	Plombierplatte Form C	59042



EASK 51.6

Aufsteck-Stromwandler – Verrechnung



Schiene 1	50 x 12 mm
Schiene 2	40 x 30 mm
Rundleiter	40 mm
Baubreite	95 mm
Bauhöhe	116 mm
Bautiefe gesamt	74 mm

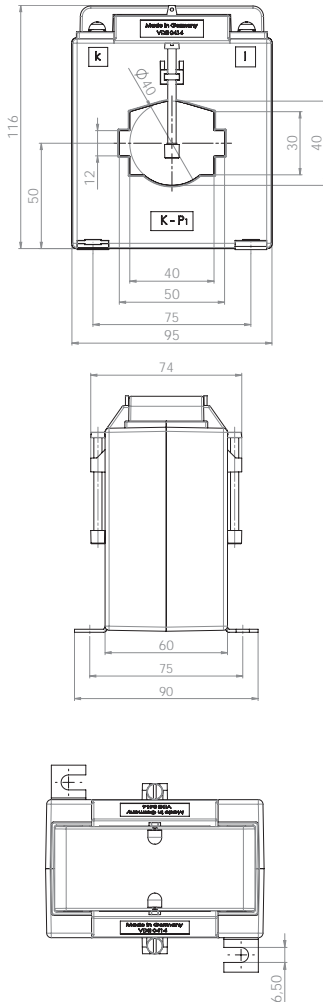

Primärstrom [A]	Bürde [VA]	Sekundärstrom [A] / Klasse				
		5 A Kl. 0,5 Best.-Nr.	5 A Kl. 0,5s Best.-Nr.	5 A Kl. 0,2 Best.-Nr.	1 A Kl. 0,5 Best.-Nr.	1 A Kl. 0,2 Best.-Nr.
100	2,5	17555	17599	17511	17755	17711
	5	17556	17600		17756	
150	2,5	17557	17601	17513	17757	17713
	5	17558	17602	17514	17758	17714
200	2,5	17560	17604	17516	17760	17716
	5	17561	17605	17517	17761	17717
250	2,5	17563	17607	17519	17763	17719
	5	17564	17608	17520	17764	17720
300	2,5	17565	17609	17521	17765	17721
	5	17566	17610		17766	
350	2,5	17567	17611	17523	17767	17723
	5	17568	17612	17524	17768	17724
400	2,5	17569	17613	17525	17769	17725
	5	17570	17614		17770	
450	2,5	17571	17615	17527	17771	17727
	5	17572	17616	17528	17772	17728
500	2,5	17573	17617	17529	17773	17729
	5	17574	17618		17774	
550	2,5	17575	17619	17531	17775	17731
	5	17576	17620	17532	17776	17732
600	2,5	17577	17621	17533	17777	17733
	5	17578	17622		17778	
650	2,5	17579	17623	17535	17779	17735
	5	17580	17624	17536	17780	17736
700	2,5	17581	17625	17537	17781	17737
	5	17582	17626	17538	17782	17738
750	2,5	17583	17627	17539	17783	17739
	5	17584	17628	17540	17784	17740
800	2,5	17585	17629	17541	17785	17741
	5	17586	17630	17542	17786	17742
850	2,5	17587	17631	17543	17787	17743
	5	17588	17632	17544	17788	17744
900	2,5	17589	17633	17545	17789	17745
	5	17590	17634		17790	
950	2,5	17591	17635	17547	17791	17747
	5	17592	17636	17548	17792	17748
1000	2,5	17593	17637	17549	17793	17749
	5	17594	17638		17794	
1050	2,5	17595	17639	17551	17795	17751
	5	17596	17640	17552	17796	17752
1100	2,5	17597	17641	17553	17797	17753
	5	17598	17642		17798	

		Best.-Nr.
	Schnappbefestigung	–
	Plombierplatte Form E	59044



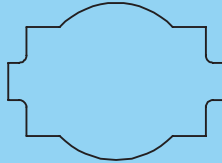
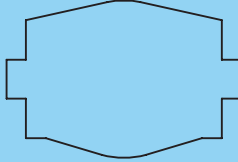
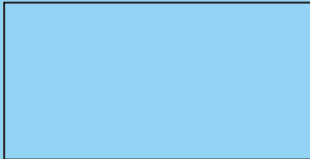
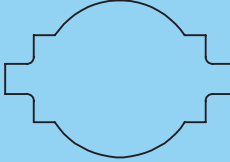

Stromwandler für Verrechnung

EASK 61.4	Primärleiter		60 x 10 mm
	Rundleiter		2 x 50 x 10 mm
	Wandlerbreite		Ø 44 mm 96 mm
EASK 61.6	Primärleiter		60 x 10 mm
	Rundleiter		50 x 30 mm
	Wandlerbreite		Ø 40 mm 95 mm
EASK 63.6	Primärleiter		60 x 30 mm
	Rundleiter		Ø 30 mm
	Wandlerbreite		88 mm
EASK 81.4	Primärleiter		80 x 10 mm
	Rundleiter		60 x 30 mm
	Wandlerbreite		2 x 60 x 10 mm Ø 55 mm 120 mm

Type „E“ bedeutet, dass die Stromwandler zu Eichzwecken geeignet sind.



EASK 61.4

Aufsteck-Stromwandler – Verrechnung



Schiene 1	60 x 10 mm
Schiene 2	2 x 50 x 10 mm
Rundleiter	44 mm
Baubreite	96 mm
Bauhöhe	108,5 mm
Bautiefe gesamt	58 mm

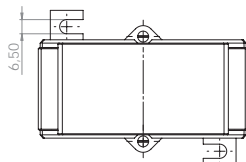
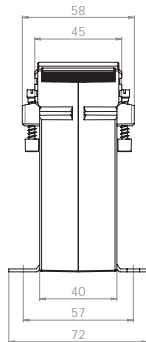
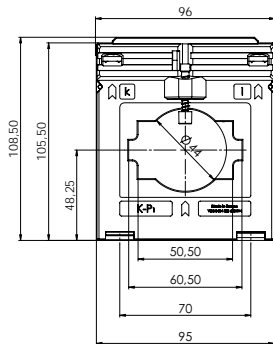

Primärstrom [A]	Bürde [VA]	Sekundärstrom [A] / Klasse				
		5 A Kl. 0,5 Best.-Nr.	5 A Kl. 0,5s Best.-Nr.	5 A Kl. 0,2 Best.-Nr.	1 A Kl. 0,5 Best.-Nr.	1 A Kl. 0,2 Best.-Nr.
200	1,5	19555	19599	19511	19755	19711
	2,5	19556	19600	19512	19756	19712
250	1,5	19557	19601	19513	19757	19713
	2,5	19558	19602	19514	19758	19714
	5	19559	19603	19515	19759	19715
300	1,5	19560	19604	19516	19760	19716
	2,5	19561	19605	19517	19761	19717
	5	19562	19606	19518	19762	19718
	10	19563	19607		19763	
400	2,5	19564	19608	19520	19764	19720
	5	19565	19609	19521	19765	19721
	10	19566	19610	19522	19766	19722
500	2,5	19567	19611	19523	19767	19723
	5	19568	19612	19524	19768	19724
	10	19569	19613	19525	19769	19725
	15	19570	19614		19770	
600	2,5	19571	19615	19527	19771	19727
	5	19572	19616	19528	19772	19728
	10	19573	19617	19529	19773	19729
750	15	19574	19618	19530	19774	19730
	2,5	19575	19619	19531	19775	19731
	5	19576	19620	19532	19776	19732
	10	19577	19621	19533	19777	19733
1000	15	19578	19622	19534	19778	19734
	5	19581	19625	19537	19780	19737
	10	19582	19626	19538	19781	19738
1200	15	19583	19627	19539	19782	19739
	2,5	19585	19629	19541		
	5	19586	19630	19542	19785	19741
	10	19587	19631	19543	19786	19742
1250	15	19588	19632	19544	19787	19743
	5	19590	19634	19546	19790	19746
	10	19591	19635	19547	19791	19747
	15	19592	19636	19548	19792	19748
1500	30	19593	19637			
	5	19595	19639	19551	19795	19751
	10	19596	19640	19552	19796	19752
	15	19597	19641	19553	19797	19753
	30	19598	19642			

		Best.-Nr.
	Schnappbefestigung	–
	Plombierplatte Form C	59042



EASK 61.6

Aufsteck-Stromwandler – Verrechnung



- Schiene 1 60 x 10 mm
- Schiene 2 50 x 30 mm
- Rundleiter 40 mm
- Baubreite 95 mm
- Bauhöhe 116 mm
- Bautiefe gesamt 74 mm

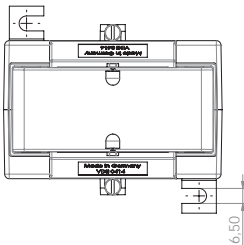
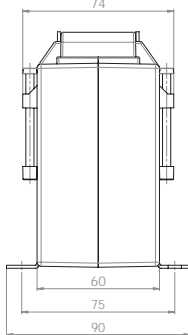
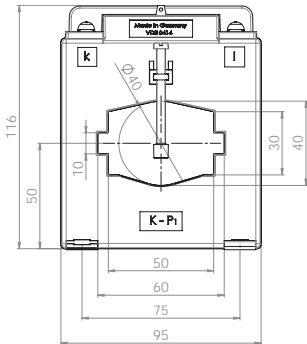

Primärstrom [A]	Bürde [VA]	Sekundärstrom [A] / Klasse				
		5 A Kl. 0,5 Best.-Nr.	5 A Kl. 0,5s Best.-Nr.	5 A Kl. 0,2 Best.-Nr.	1 A Kl. 0,5 Best.-Nr.	1 A Kl. 0,2 Best.-Nr.
200	2,5	20552	20593	20511	20752	20711
	5	20553	20594		20753	
250	2,5	20554	20595	20513	20754	20713
	5	20555	20596	20514	20755	20714
300	10	20556	20597		20756	
	2,5	20557	20598	20516	20757	20716
	5	20558	20599	20517	20758	20717
300	10	20559	20600	20518	20759	20718
	15	20560	20601		20760	
	2,5	20561	20602	20520	20761	20720
400	5	20562	20603	20521	20762	20721
	10	20563	20604	20522	20763	20722
	15	20564	20605		20764	
500	2,5	20565	20606	20524	20765	20724
	5	20566	20607	20525	20766	20725
	10	20567	20608	20526	20767	20726
	15	20568	20609		20768	
600	2,5	20569	20610	20528	20769	20728
	5	20570	20611	20529	20770	20729
	10	20571	20612	20530	20771	20730
600	15	20572	20613		20772	
	2,5	20573	20614	20532	20773	20732
	5	20574	20615	20533	20774	20733
750	10	20575	20616	20534	20775	20734
	15	20576	20617	20535	20776	20735
	15	20577	20618	20536	20777	20736
1000	5	20578	20619	20537	20778	20737
	10	20579	20620	20538	20779	20738
	15	20581	20622	20540	20781	20740
1200	10	20582	20623	20541	20782	20741
	15	20583	20624	20542	20783	20742
	30	20584	20625		20784	
	5	20585	20626	20544	20785	20744
1250	10	20586	20627	20545	20786	20745
	15	20587	20628	20546	20787	20746
	30	20588	20629		20788	
	5	20589	20630	20548	20789	20748
1500	10	20590	20631	20549	20790	20749
	15	20591	20632	20550	20791	20750
	30	20592	20633		20792	

		Best.-Nr.
	Schnappbefestigung	–
	Plombierplatte Form E	59044

EASR

EASK

EWSK / ESUSK

EASKD / EWSKD



EASK 63.6

Aufsteck-Stromwandler – Verrechnung



Schiene 1 60 x 30 mm
 Rundleiter 30 mm
 Baubreite 88 mm
 Bauhöhe 132 mm
 Bautiefe gesamt 78 mm

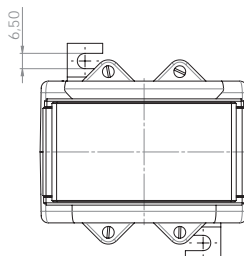
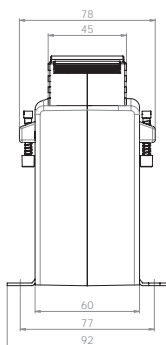
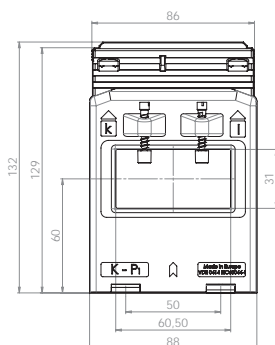

Primärstrom [A]	Bürde [VA]	Sekundärstrom [A] / Klasse				
		5 A Kl. 0,5 Best.-Nr.	5 A Kl. 0,5s Best.-Nr.	5 A Kl. 0,2 Best.-Nr.	1 A Kl. 0,5 Best.-Nr.	1 A Kl. 0,2 Best.-Nr.
250	2,5	85558	85602	85513	85758	85713
	5	85559	85603		85759	
300	2,5	85560	85604	85515	85760	85715
	5	85561	85605	85516	85761	85716
	10	85562	85606		85762	
400	2,5	85563	85607	85518	85763	85718
	5	85564	85608	85519	85764	85719
	10	85565	85609		85765	
500	2,5	85566	85610	85521	85766	85721
	5	85567	85611	85522	85767	85722
	10	85568	85612	85523	85768	85723
	15	85569	85613		85769	
600	2,5	85570	85614	85525	85770	85725
	5	85571	85615	85526	85771	85726
	10	85572	85616	85527	85772	85727
	15	85573	85617	85528	85773	85728
750	5	85574	85618	85530	85774	85730
	10	85575	85619	85531	85775	85731
	15	85576	85620	85532	85776	85732
	30	85577	85621		85777	
1000	5	85578	85622	85534	85778	85734
	10	85579	85623	85535	85779	85735
	15	85580	85624	85536	85780	85736
	30	85581	85625		85781	
1200	5	85582	85626	85538	85782	85738
	10	85583	85627	85539	85783	85739
	15	85584	85628	85540	85784	85740
	30	85585	85629		85785	
1250	5	85586	85630	85542	85786	85742
	10	85587	85631	85543	85787	85743
	15	85588	85632	85544	85788	85744
	30	85589	85633		85789	
1500	5	85590	85634	85546	85790	85746
	10	85591	85635	85547	85791	85747
	15	85592	85636	85548	85792	85748
	30	85593	85637		85793	

		Best.-Nr.
	Schnappbefestigung	–
	Plombierplatte Form C	59042



EASK 81.4

Aufsteck-Stromwandler – Verrechnung



- Schiene 1 80 x 10 mm
- Schiene 2 60 x 30 mm
- Schiene 3 2 x 60 x 10 mm
- Rundleiter 55 mm
- Baubreite 120 mm
- Bauhöhe 126,5 mm
- Bautiefe gesamt 58 mm

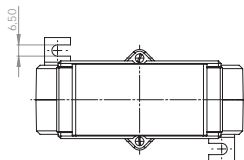
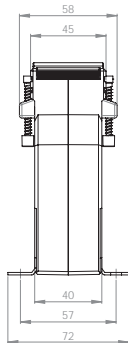
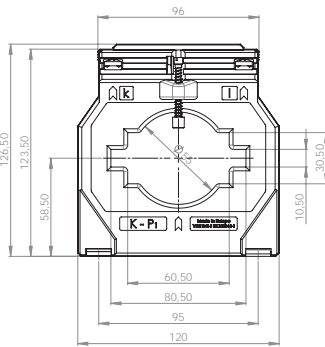

Primärstrom [A]	Bürde [VA]	Sekundärstrom [A] / Klasse				
		5 A Kl. 0,5 Best.-Nr.	5 A Kl. 0,5s Best.-Nr.	5 A Kl. 0,2 Best.-Nr.	1 A Kl. 0,5 Best.-Nr.	1 A Kl. 0,2 Best.-Nr.
400	2,5	21541	21571	21511	21741	21711
	5	21542	21572	21512	21742	21712
	10	21543			21743	
500	2,5	21544	21574	21514	21744	21714
	5	21545	21575	21515	21745	21715
	10	21546	21576	21516	21746	21716
600	2,5	21547	21577	21517	21747	21717
	5	21548	21578	21518	21748	21718
	10	21549	21579	21519	21749	21719
750	2,5	21551	21581	21521	21751	21721
	5	21552	21582	21522	21752	21722
	10	21553	21583	21523	21753	21723
1000	5	21556	21586	21526	21756	21726
	10	21557	21587	21527	21757	21727
	15	21558	21588		21758	
1200	5	21560	21590	21530	21760	21730
	10	21561	21591	21531	21761	21731
	15	21562	21592	21532	21762	21732
1250	5	21564	21594	21534	21764	21734
	10	21565	21595	21535	21765	21735
	15	21566	21596	21536	21766	21736
1500	5	21568	21598	21538	21768	21738
	10	21569	21599	21539	21769	21739
	15	21570	21600	21540	21770	21740

		Best.-Nr.
	Schnappbefestigung	–
	Plombierplatte Form C	59042

EASR

EASK

EWSK /
ESUSK

EASKD /
EWSKD





Stromwandler für Verrechnung

EASK 105.6

Primärleiter
Rundleiter
Wandlerbreite



100 x 55 mm
Ø 55 mm
129 mm

EASK 123.3

Primärleiter
Rundleiter
Wandlerbreite

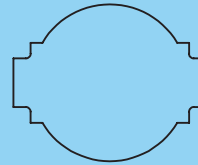

123 x 30 mm
3 x 100 x 30 mm
Ø 100 mm
172 mm

EASK 130.3

Primärleiter
Wandlerbreite



130 x 25 mm
180 mm

EASK 130.5

Primärleiter
Wandlerbreite



130 x 30 mm
180 mm

Type „E“ bedeutet, dass die Stromwandler zu Eichzwecken geeignet sind.



EASK 105.6

Aufsteck-Stromwandler - Verrechnung



Schiene 1 100 x 55 mm
 Rundleiter 55 mm
 Baubreite 129 mm
 Bauhöhe 170 mm
 Bautiefe gesamt 78 mm

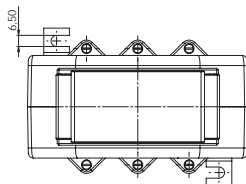
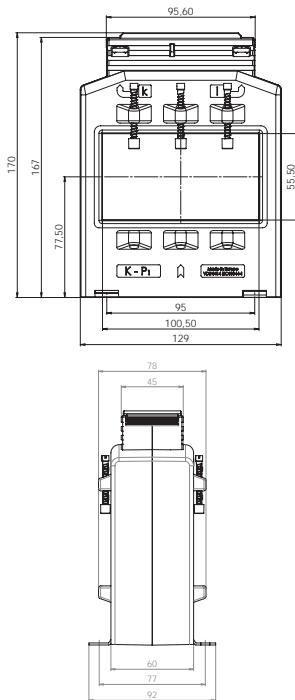

Primärstrom [A]	Bürde [VA]	Sekundärstrom [A] / Klasse				
		5 A Kl. 0,5 Best.-Nr.	5 A Kl. 0,5s Best.-Nr.	5 A Kl. 0,2 Best.-Nr.	1 A Kl. 0,5 Best.-Nr.	1 A Kl. 0,2 Best.-Nr.
600	2,5	86568	86622	86515	86768	86715
	5	86569	86623	86516	86769	86716
750	2,5	86571	86625	86518	86771	86718
	5	86572	86626	86519	86772	86719
	10	86573	86627	86520	86773	86720
1000	2,5	86574				
	5	86575	86629	86522	86775	86722
	10	86576	86630	86523	86776	86723
	15	86577	86631	86524	86777	86724
1200	5	86579	86633	86526	86779	86726
	10	86580	86634	86527	86780	86727
	15	86581	86635	86528	86781	86728
1250	5	86583	86637	86530	86783	86730
	10	86584	86638	86531	86784	86731
	15	86585	86639	86532	86785	86732
	30	86586	86640		86786	
1500	5	86588	86642	86535	86788	86735
	10	86589	86643	86536	86789	86736
	15	86590	86644	86537	86790	86737
	30	86591	86645	86538	86791	86738
1600	5		86647	86540		
	10	86594	86648	86541	86794	86741
	15	86595	86649	86542	86795	86742
2000	30	86596	86650	86543	86796	86743
	5	86598	86652	86545		
	10	86599	86653	86546	86799	86746
2500	15	86600	86654	86547	86800	86747
	30	86601	86655	86548	86801	86748
	5	86603	86657	86550		
	10	86604	86658	86551	86804	86751
3000	15	86605	86659	86552	86805	86752
	30	86606	86660	86553	86806	86753
	5		86662	86555		
	10	86609	86663	86556	86809	86756
3000	15	86610	86664	86557	86810	86757
	30	86611	86665	86558	86811	86758

		Best.-Nr.
	Schnappbefestigung	-
	Plombierplatte Form C	59042



EASK 123.3

Aufsteck-Stromwandler - Verrechnung



- Schiene 1 120 x 30 mm
- Schiene 2 3 x 100 x 10 mm
- Rundleiter 100 mm
- Baubreite 172 mm
- Bauhöhe 187,5 mm
- Bautiefe gesamt 52 mm

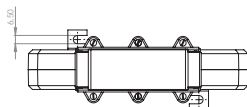
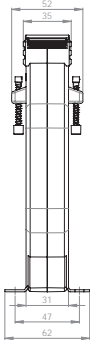
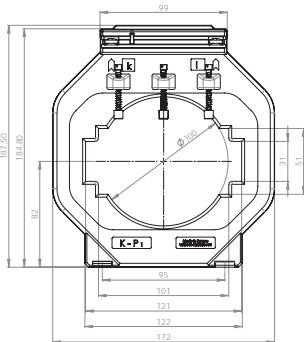

Primärstrom [A]	Bürde [VA]	Sekundärstrom [A] / Klasse		
		5 A Kl. 0,5 Best.-Nr.	5 A Kl. 0,5s Best.-Nr.	5 A Kl. 0,2 Best.-Nr.
750	2,5	V56-2301D	V56-2302D	
	5	V56-2301F	V56-2302F	
	10	V56-2301H	V56-2302H	
1000	2,5	V56-2501D	V56-2502D	V56-2503D
	5	V56-2501F	V56-2502F	V56-2503F
	10	V56-2501H	V56-2502H	
1200	5	V56-2601F	V56-2602F	V56-2603F
	10	V56-2601H	V56-2602H	V56-2603H
	15	V56-2601J	V56-2602J	
1250	5	V56-2701F	V56-2702F	V56-2703F
	10	V56-2701H	V56-2702H	V56-2703H
	15	V56-2701J	V56-2702J	V56-2703J
1500	5	V56-2801F	V56-2802F	V56-2803F
	10	V56-2801H	V56-2802H	V56-2803H
	15	V56-2801J	V56-2802J	V56-2803J
1600	5	V56-2901F	V56-2902F	V56-2903F
	10	V56-2901H	V56-2902H	V56-2903H
	15	V56-2901J	V56-2902J	V56-2903J
2000	5	V56-3001F	V56-3002F	V56-3003F
	10	V56-3001H	V56-3002H	V56-3003H
	15	V56-3001J	V56-3002J	V56-3003J
	30	V56-3001L	V56-3002L	
2500	5	V56-3201F	V56-3202F	V56-3203F
	10	V56-3201H	V56-3202H	V56-3203H
	15	V56-3201J	V56-3202J	V56-3203J
	30	V56-3201L	V56-3202L	
3000	5	V56-3301F	V56-3302F	V56-3303F
	10	V56-3301H	V56-3302H	V56-3303H
	15	V56-3301J	V56-3302J	V56-3303J
	30	V56-3301L	V56-3302L	

		Best.-Nr.
	Schnappbefestigung	-
	Plombierplatte Form A	59040

EASR

EASK

EWSK /
ESUSK

EASKD /
EWSKD



EASK 123.3

Aufsteck-Stromwandler - Verrechnung



Schiene 1	120 x 30 mm
Schiene 2	3 x 100 x 10 mm
Rundleiter	100 mm
Baubreite	172 mm
Bauhöhe	187,5 mm
Bautiefe gesamt	52 mm

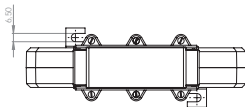
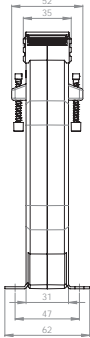
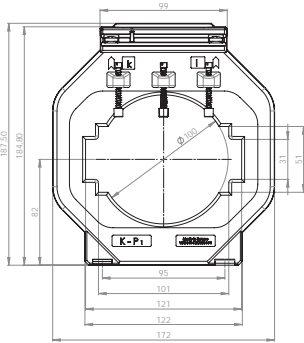

Primärstrom [A]	Bürde [VA]	Sekundärstrom [A] / Klasse		
		1 A Kl. 0,5 Best.-Nr.	1 A Kl. 0,5s Best.-Nr.	1 A Kl. 0,2 Best.-Nr.
750	2,5	V56-2311D	V56-2312D	
	5	V56-2311F	V56-2312F	
	10	V56-2311H	V56-2312H	
1000	2,5	V56-2511D	V56-2512D	V56-2513D
	5	V56-2511F	V56-2512F	V56-2513F
	10	V56-2511H	V56-2512H	
1200	5	V56-2611F	V56-2612F	V56-2613F
	10	V56-2611H	V56-2612H	V56-2613H
	15	V56-2611J	V56-2612J	
1250	5	V56-2711F	V56-2712F	V56-2713F
	10	V56-2711H	V56-2712H	V56-2713H
	15	V56-2711J	V56-2712J	V56-2713J
1500	5	V56-2811F	V56-2812F	V56-2813F
	10	V56-2811H	V56-2812H	V56-2813H
	15	V56-2811J	V56-2812J	V56-2813J
	30	V56-2811L	V56-2812L	
1600	5	V56-2911F	V56-2912F	V56-2913F
	10	V56-2911H	V56-2912H	V56-2913H
	15	V56-2911J	V56-2912J	V56-2913J
	30	V56-2911L	V56-2912L	
2000	5	V56-3011F	V56-3012F	V56-3013F
	10	V56-3011H	V56-3012H	V56-3013H
	15	V56-3011J	V56-3012J	V56-3013J
	30	V56-3011L	V56-3012L	
2500	5	V56-3211F	V56-3212F	V56-3213F
	10	V56-3211H	V56-3212H	V56-3213H
	15	V56-3211J	V56-3212J	V56-3213J
	30	V56-3211L	V56-3212L	

		Best.-Nr.
	Schnappbefestigung	–
	Plombierplatte Form A	59040



EASK 130.3

Aufsteck-Stromwandler - Verrechnung



Schiene 1 130 x 25 mm
 Baubreite 180 mm
 Bauhöhe 100 mm
 Bautiefe gesamt 50 mm

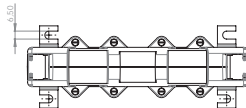
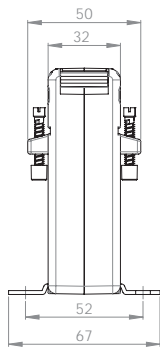
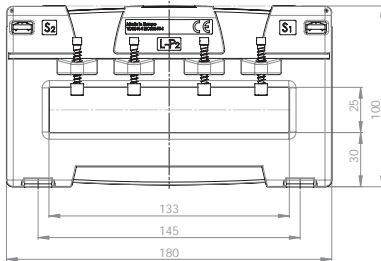

Primärstrom [A]	Bürde [VA]	Sekundärstrom [A] / Klasse				
		5 A Kl. 0,5 Best.-Nr.	5 A Kl. 0,5s Best.-Nr.	5 A Kl. 0,2 Best.-Nr.	1 A Kl. 0,5 Best.-Nr.	1 A Kl. 0,2 Best.-Nr.
300	2,5	V50-1901D	V50-1902D		V50-1911D	
	5	V50-1901F			V50-1911F	
400	2,5	V50-2001D	V50-2002D	V50-2003D	V50-2011D	V50-2013D
	5	V50-2001F	V50-2002F		V50-2011F	
500	2,5	V50-2101D	V50-2102D	V50-2103D	V50-2111D	V50-2113D
	5	V50-2101F	V50-2102F		V50-2111F	
600	2,5	V50-2201D	V50-2202D	V50-2203D	V50-2211D	V50-2213D
	5	V50-2201F	V50-2202F	V50-2203F	V50-2211F	V50-2213F
	10	V50-2201H			V50-2211H	
750	2,5	V50-2301D	V50-2302D	V50-2303D	V50-2311D	V50-2313D
	5	V50-2301F	V50-2302F	V50-2303F	V50-2311F	V50-2313F
	10	V50-2301H	V50-2302H		V50-2311H	
	15	V50-2301J			V50-2311J	
1000	5	V50-2501F	V50-2502F	V50-2503F	V50-2511F	V50-2513F
	10	V50-2501H	V50-2502H		V50-2511H	
	15	V50-2501J	V50-2502J		V50-2511J	
1200	5	V50-2601F	V50-2602F	V50-2603F	V50-2611F	V50-2613F
	10	V50-2601H	V50-2602H	V50-2603H	V50-2611H	V50-2613H
	15	V50-2601J	V50-2602J		V50-2611J	
1250	5	V50-2701F	V50-2702F	V50-2703F	V50-2711F	V50-2713F
	10	V50-2701H	V50-2702H	V50-2703H	V50-2711H	V50-2713H
	15	V50-2701J	V50-2702J	V50-2703J	V50-2711J	V50-2713J
1500	5	V50-2801F	V50-2802F	V50-2803F	V50-2811F	V50-2813F
	10	V50-2801H	V50-2802H	V50-2803H	V50-2811H	V50-2813H
	15	V50-2801J	V50-2802J	V50-2803J	V50-2811J	V50-2813J
	30	V50-2801L	V50-2802L		V50-2811L	
1600	5	V50-2901F	V50-2902F	V50-2903F	V50-2911F	V50-2913F
	10	V50-2901H	V50-2902H	V50-2903H	V50-2911H	V50-2913H
	15	V50-2901J	V50-2902J	V50-2903J	V50-2911J	V50-2913J
	30	V50-2901L	V50-2902L		V50-2911L	

		Best.-Nr.
	Schnappbefestigung	-
	Plombierplatte	-



EASK 130.5

Aufsteck-Stromwandler - Verrechnung



Schiene 1 130 x 30 mm
 Baubreite 180 mm
 Bauhöhe 120 mm
 Bautiefe gesamt 68 mm

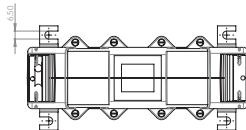
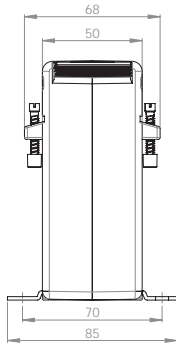
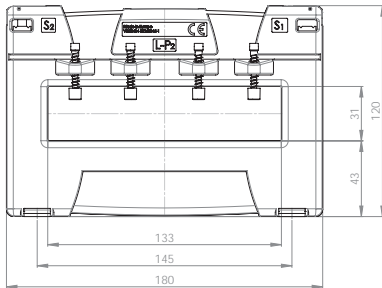

Primärstrom [A]	Bürde [VA]	Sekundärstrom [A] / Klasse				
		5 A Kl. 0,5 Best.-Nr.	5 A Kl. 0,5s Best.-Nr.	5 A Kl. 0,2 Best.-Nr.	1 A Kl. 0,5 Best.-Nr.	1 A Kl. 0,2 Best.-Nr.
300	2,5	V51-1901D	V51-1902D		V51-1911D	
	5	V51-1901F	V51-1902F		V51-1911F	
	10	V51-1901H			V51-1911H	
400	2,5	V51-2001D	V51-2002D	V51-2003D	V51-2011D	V51-2013D
	5	V51-2001F	V51-2002F		V51-2011F	
	10	V51-2001H	V51-2002H		V51-2011H	
500	2,5	V51-2101D	V51-2102D	V51-2103D	V51-2111D	V51-2113D
	5	V51-2101F	V51-2102F	V51-2103F	V51-2111F	V51-2113F
	10	V51-2101H	V51-2102H		V51-2111H	
600	2,5	V51-2201D	V51-2202D	V51-2203D	V51-2211D	V51-2213D
	5	V51-2201F	V51-2202F	V51-2203F	V51-2211F	V51-2213F
	10	V51-2201H	V51-2202H		V51-2211H	
750	2,5	V51-2301D	V51-2302D		V51-2311D	V51-2313D
	5	V51-2301F	V51-2302F	V51-2303F	V51-2311F	V51-2313F
	10	V51-2301H	V51-2302H	V51-2303H	V51-2311H	V51-2313H
	15	V51-2301J	V51-2302J		V51-2311J	
1000	5	V51-2501F	V51-2502F	V51-2503F	V51-2511F	V51-2513F
	10	V51-2501H	V51-2502H	V51-2503H	V51-2511H	V51-2513H
	15	V51-2501J	V51-2502J	V51-2503J	V51-2511J	V51-2513J
	30	V51-2501L	V51-2502L		V51-2511L	
1200	5	V51-2601F	V51-2602F	V51-2603F	V51-2611F	V51-2613F
	10	V51-2601H	V51-2602H	V51-2603H	V51-2611H	V51-2613H
	15	V51-2601J	V51-2602J	V51-2603J	V51-2611J	V51-2613J
	30	V51-2601L	V51-2602L		V51-2611L	
1250	5	V51-2701F	V51-2702F	V51-2703F	V51-2711F	V51-2713F
	10	V51-2701H	V51-2702H	V51-2703H	V51-2711H	V51-2713H
	15	V51-2701J	V51-2702J	V51-2703J	V51-2711J	V51-2713J
	30	V51-2701L	V51-2702L		V51-2711L	
1500	5	V51-2801F	V51-2802F	V51-2803F	V51-2811F	V51-2813F
	10	V51-2801H	V51-2802H	V51-2803H	V51-2811H	V51-2813H
	15	V51-2801J	V51-2802J	V51-2803J	V51-2811J	V51-2813J
	30	V51-2801L	V51-2802L		V51-2811L	
1600	10	V51-2901H	V51-2902H	V51-2903H	V51-2911H	V51-2913H
	15	V51-2901J	V51-2902J	V51-2903J	V51-2911J	V51-2913J
	30	V51-2901L	V51-2902L		V51-2911L	
2000	10	V51-3001H	V51-3002H	V51-3003H	V51-3011H	V51-3013H
	15	V51-3001J	V51-3002J	V51-3003J	V51-3011J	V51-3013J
	30	V51-3001L	V51-3002L	V51-3003L	V51-3011L	V51-3013L
2400	10	V51-3101H	V51-3102H	V51-3103H	V51-3111H	V51-3113H
	15	V51-3101J	V51-3102J	V51-3103J	V51-3111J	V51-3113J
	30	V51-3101L	V51-3102L	V51-3103L	V51-3111L	V51-3113L
2500	10	V51-3201H	V51-3202H	V51-3203H	V51-3211H	V51-3213H
	15	V51-3201J	V51-3202J	V51-3203J	V51-3211J	V51-3213J
	30	V51-3201L	V51-3202L	V51-3203L	V51-3211L	V51-3213L
3000	10	V51-3301H	V51-3302H	V51-3303H	V51-3311H	V51-3313H
	15	V51-3301J	V51-3302J	V51-3303J	V51-3311J	V51-3313J
	30	V51-3301L	V51-3302L	V51-3303L	V51-3311L	V51-3313L







Stromwandler für Verrechnung

Wickel-Stromwandler

EWSK 31.5

Wandlerbreite

70 mm

Summen-Stromwandler

ESUSK 2...8

Wandlerbreite

156 mm

Wandlertiefe

65 mm

Type „E“ bedeutet, dass die Stromwandler zu Eichzwecken geeignet sind.



EWSK 31.5

Wickel-Stromwandler – Verrechnung



Baubreite 70 mm
 Bauhöhe 100 mm
 Bautiefe gesamt 115 mm

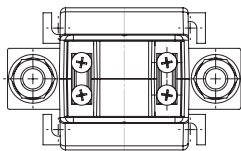
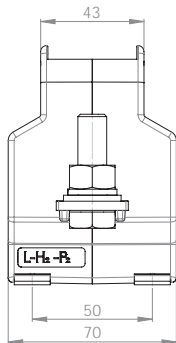
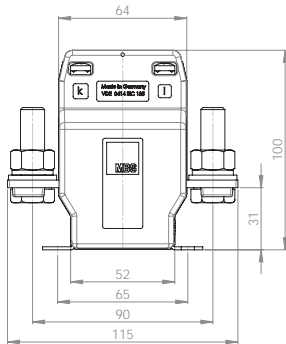

Primärstrom [A]	Bürde [VA]	Sekundärstrom [A] / Klasse				
		5 A Kl. 0,5 Best.-Nr.	5 A Kl. 0,5s Best.-Nr.	5 A Kl. 0,2 Best.-Nr.	1 A Kl. 0,5 Best.-Nr.	1 A Kl. 0,2 Best.-Nr.
25	2,5	33547	33583	33511	33747	33711
	5	33548	33584	33512	33748	33712
	10	33549	33585	33513	33749	33713
	15	33550	33586		33750	
30	2,5	33551	33587	33515	33751	33715
	5	33552	33588	33516	33752	33716
	10	33553	33589	33517	33753	33717
	15	33554	33590		33754	
40	2,5	33555	33591	33519	33755	33719
	5	33556	33592	33520	33756	33720
	10	33557	33593	33521	33757	33721
	15	33558	33594		33758	
50	2,5	33559	33595	33523	33759	33723
	5	33560	33596	33524	33760	33724
	10	33561	33597	33525	33761	33725
	15	33562	33598		33762	
60	2,5	33563	33599	33527	33763	33727
	5	33564	33600	33528	33764	33728
	10	33565	33601	33529	33765	33729
	15	33566	33602		33766	
75	2,5	33567	33603	33531	33767	33731
	5	33568	33604	33532	33768	33732
	10	33569	33605	33533	33769	33733
	15	33570	33606		33770	
100	2,5	33571	33607	33535	33771	33735
	5	33572	33608	33536	33772	33736
	10	33573	33609	33537	33773	33737
	15	33574	33610		33774	
150	2,5	33575	33611	33539	33775	33739
	5	33576	33612	33540	33776	33740
	10	33577	33613	33541	33777	33741
	15	33578	33614		33778	

		Best.-Nr.
	Schnappbefestigung	–
	Plombierplatte Form F	59045



ESUSK 2...8

Summen-Stromwandler – Verrechnung



Baubreite 156 mm
 Bauhöhe 140 mm
 Bautiefe gesamt 65 mm

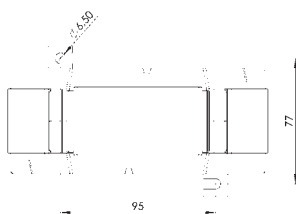
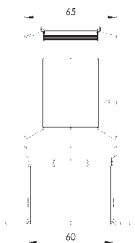
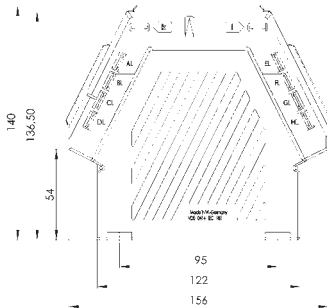

Ein-gänge	Primär-strom [A]	Bürde [VA]	Sekundärstrom [A] / Klasse	
			5 A Kl. 0,2 Best.-Nr.	
2	5	5	40511	
		10	40512	
3		5	40513	
		10	40514	
4		5	40515	
		10	40516	
5		5	40517	
		10	40518	
6		5	40519	
		10	40520	
7	5	40521		
	10	40522		
8	5	40523		
	10	40524		

		Best.-Nr.
	Schnappbefestigung	–
	Plombierplatte Form B	59041 primär
	Plombierplatte Form C	59042 sekundär

Anschlussbeispiel bei verschiedenen Übersetzungen:

- AK-AL = 1000/5
- BK-BL = 800/5
- CK-CL = 600/5
- DK-DL = 400/5
- EK-EL = 400/5
- FK-FL = 300/5
- GK-GL = 300/5
- HK-HL = 300/5

Anschlussbild

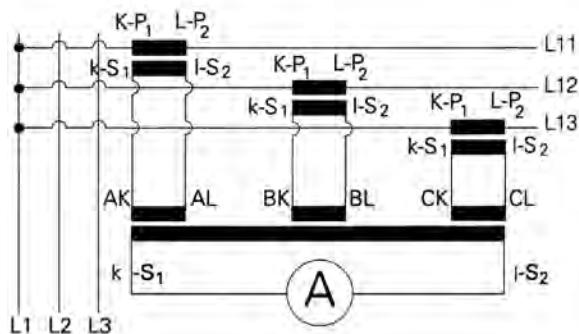

EASR
 EASK
 EWSK / ESUSK
 EASKD / EWSKD





Niederspannungs-Stromwandler für Verrechnung

Dreiphasen-Stromwandler-Satz

EASK(D) 21.3 mit Abdeckkappen
aus Plexiglas

EASK(D) 31.5 mit Abdeckkappen
EASK(D) 31.5 2U aus Plexiglas

EASK(D) 31.8 mit Abdeckkappen
EWSK(D) 31.8 aus Plexiglas



EASK(D) 21.3

Dreiphasen-Stromwandlersatz – Verrechnung

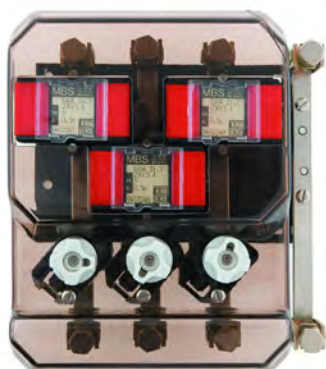

Primärstrom [A]	Bürde [VA]	Sekundärstrom [A] / Klasse				
		5 A Kl. 0,5 Best.-Nr.	5 A Kl. 0,5s Best.-Nr.	5 A Kl. 0,2 Best.-Nr.	1 A Kl. 0,5 Best.-Nr.	1 A Kl. 0,2 Best.-Nr.
3 x 100	2,5	58529	58547		58747	
	5	58532	58550	58514	58750	58714
3 x 150	2,5	58535	58553	58517	58753	58717
	5	58536	58554	58518	58754	58718

		Best.-Nr.
	Schnappbefestigung	–
	Plombierplatte Form A	59040

- Der Messwandlersatz besteht aus 3 Einzelstromwandlern, welche gemeinsam mit den Primärleitern L₁, L₂, L₃ sowie einem Neutralleiter auf einer Bodenplatte aus Aluminium montiert sind.
- **Der Wandlersatz kann wahlweise mit bzw. ohne Sicherung geliefert werden. Der Spannungsabgriff kann dann sowohl über 10 A-NEOZED Sicherungselemente als auch direkt von den einzelnen Primärleitern erfolgen.**
- Die Sekundäranschlüsse der Stromwandler können durch die im Lieferumfang enthaltenen transparenten, plombierbaren Abdeckungen gegen Fremdeingriffe gesichert werden. Nach erfolgter Montage des Messwandlersatzes sind alle spannungsführenden Teile durch eine, ebenfalls im Lieferumfang enthaltene, Isolierabdeckung gegen Berührung geschützt.
- Die Primäranschlussklemmen gestatten den Anschluss flexibler Cu-Leitungen mit einem Nennquerschnitt von 16 ... 70 mm².
- Die Ausführung dieses Wandlersatzes entspricht den Forderungen der technischen Normen und Richtlinien:
 - IEC 61869/1+2
 - DIN 42600

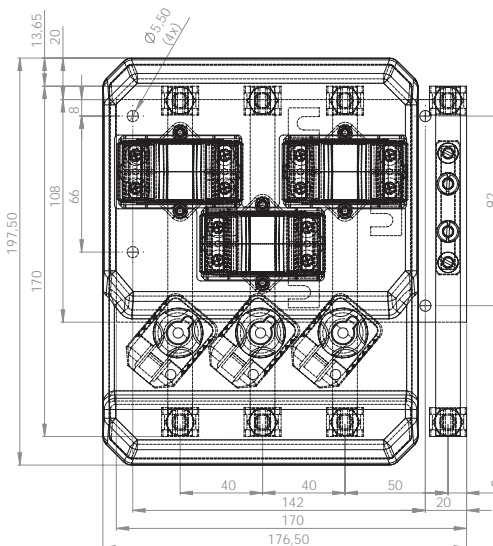
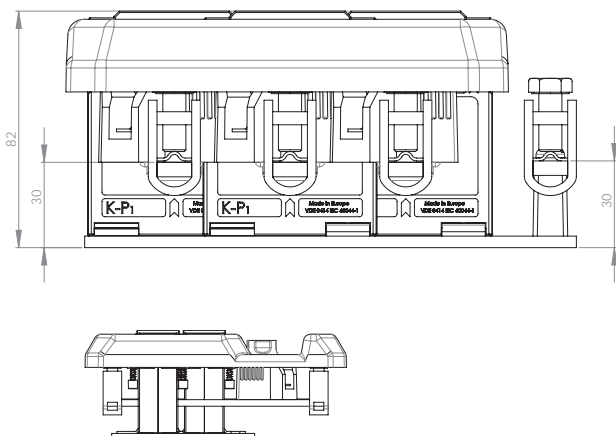



EASK(D) 31.5

Dreiphasen-Stromwandlersatz – Verrechnung

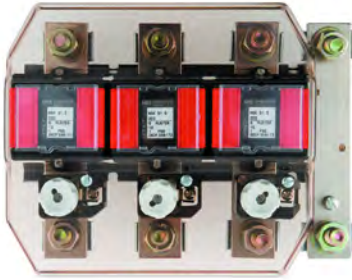

Primärstrom [A]	Bürde [VA]	Sekundärstrom [A] / Klasse				
		5 A Kl. 0,5 Best.-Nr.	5 A Kl. 0,5s Best.-Nr.	5 A Kl. 0,2 Best.-Nr.	1 A Kl. 0,5 Best.-Nr.	1 A Kl. 0,2 Best.-Nr.
3 x 75	2,5	57543	57575		57743	
	5	57544	57576	57512	57744	57712
3 x 100	2,5	57545			57745	
	5	57546	57578	57514	57746	57714
3 x 150	2,5	57547	57579	57515	57747	57715
	5	57548	57580	57516	57748	57716
3 x 200	2,5	57549	57581	57517	57749	57717
	5	57550	57582		57750	
3 x 250	2,5	57551	57583	57519	57751	57719
	5	57552	57584	57520	57752	57720
3 x 300	2,5	57553	57585	57521	57753	57721
	5	57554	57806		57754	
3 x 300	2,5	57555	57586	57523	57755	57723
	5	57556	57587	57524	57756	57724
3 x 300	10	57557	57588	57525	57757	57725
	15	57558	57805		57758	
3 x 400	2,5	57559	57589	57527	57759	57727
	5	57560	57590	57528	57760	57728
3 x 400	10	57561	57591	57529	57761	57729
	15	57562	57592		57762	
3 x 500	2,5	57563	57593	57531	57763	57731
	5	57564	57594	57532	57764	57732
3 x 500	10	57565	57595	57533	57765	57733
	15	57566	57596		57766	
3 x 600	2,5	57567	57597	57535	57767	57735
	5	57568	57598	57536	57768	57736
3 x 600	10	57569	57599	57537	57769	57737
	15	57570	57600		57770	
3 x 750	2,5	57571	57601	57539	57771	57739
	5	57572	57602	57540	57772	57740
3 x 750	10	57573	57603	57541	57773	57741
	15	57574	57604	57542	57774	57742

		Best.-Nr.
	Schnappbefestigung	–
	Plombierplatte Form B	59041

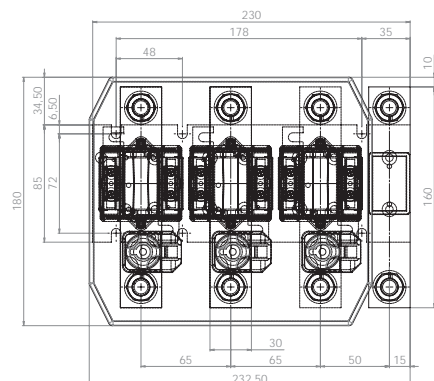
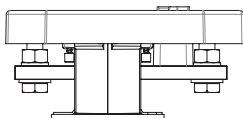
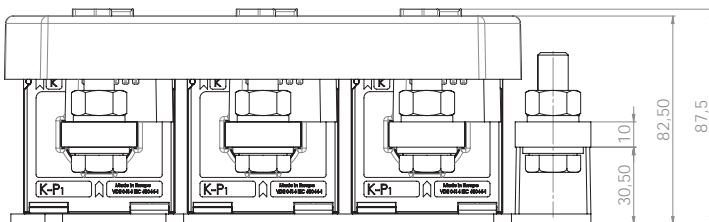



EASK(D) 31.5 2U

Dreiphasen-Stromwandlersatz,
sekundär umschaltbar – Verrechnung

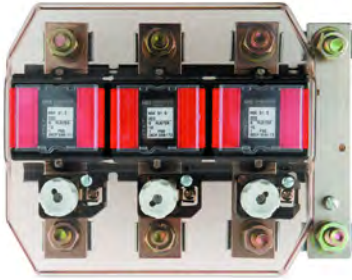

		Sekundärstrom [A] / Klasse	
Primärstrom [A]	Bürde [VA]	5 A Kl. 0,5 Best.-Nr.	5 A Kl. 0,5s Best.-Nr.
3 x 200-100	5-2,5	57605	57615
3 x 200-100	10-5	57606	
3 x 300-150	5-2,5	57607	57617
	10-5	57608	57618
3 x 400-200	5-2,5	57609	57619
	10-5	57610	57620
3 x 500-250	5-2,5	57611	57621
	10-5	57612	57622
3 x 600-300	5-2,5	57613	57623
	10-5	57614	57624

		Best.-Nr.
	Schnappbefestigung	–
	Plombierplatte	–

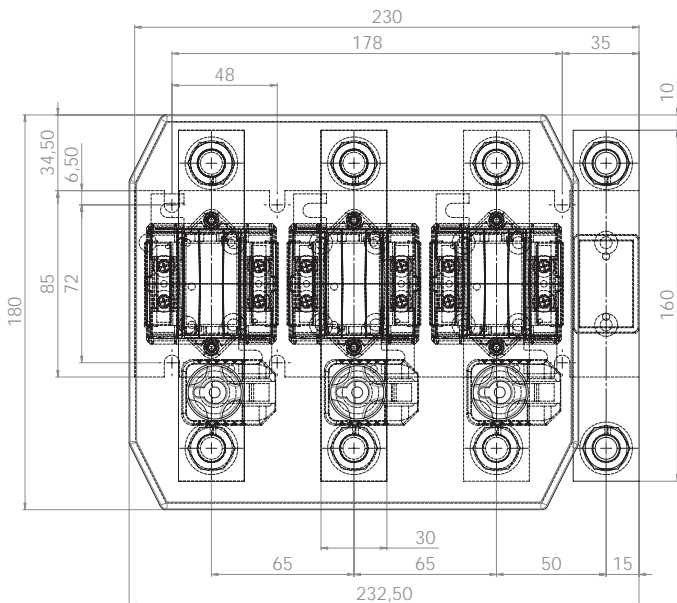
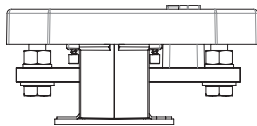
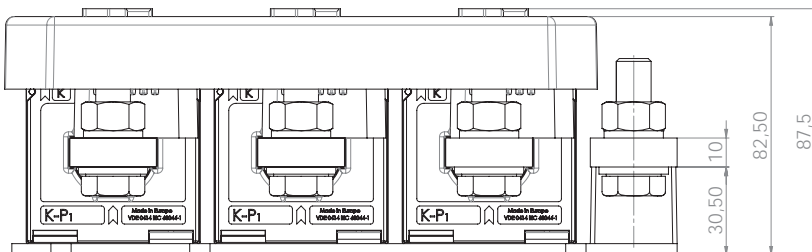



EWSKD 31.8 mit Bodenplatte

Dreiphasen-Stromwandlersatz – Verrechnung



Primärstrom [A]	Bürde [VA]	Sekundärstrom [A] / Klasse				
		5 A Kl. 0,5s Best.-Nr.	5 A Kl. 0,5 Best.-Nr.	5 A Kl. 0,2 Best.-Nr.	1 A Kl. 0,5 Best.-Nr.	1 A Kl. 0,2 Best.-Nr.
3 x 50	2,5	44601	44561	44511	44761	44711
	5	44602	44562	44512	44762	44712
	10	44603	44563		44763	
3 x 75	2,5	44605	44565	44515	44765	44715
	5	44606	44566	44516	44766	44716
	10	44607	44567		44767	
3 x 100	2,5	44609	44569	44519	44769	44719
	5	44610	44570	44520	44770	44720
	10	44611	44571		44771	
3 x 150	2,5	44613	44573	44523	44773	44723
	5	44614	44574	44524	44774	44724
	10	44615	44575	44525	44775	44725

		Best.-Nr.
	Schnappbefestigung	–
	Plombierplatte	–

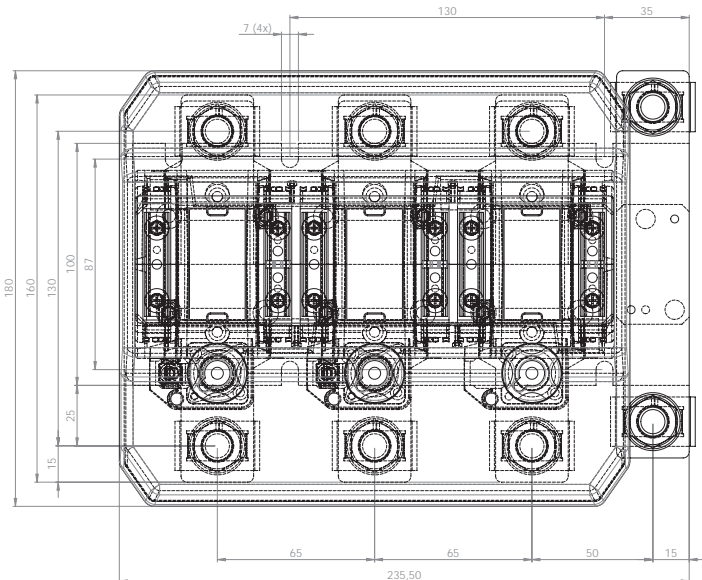
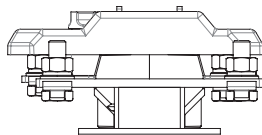
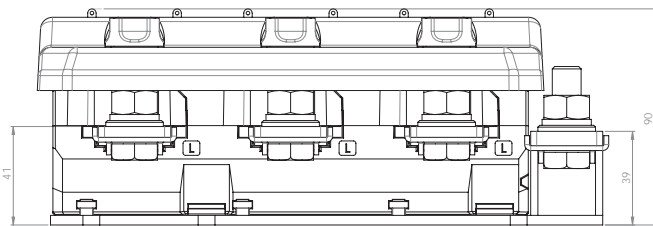

EASR
EASK
EWSK / ESUK
EASKD / EWSKD



EWSKD 31.8 ohne Bodenplatte und Nullleiter

Dreiphasen-Stromwandlersatz – Verrechnung



Primärstrom [A]	Bürde [VA]	Sekundärstrom [A] / Klasse				
		5 A Kl. 0,5s Best.-Nr.	5 A Kl. 0,5 Best.-Nr.	5 A Kl. 0,2 Best.-Nr.	1 A Kl. 0,5 Best.-Nr.	1 A Kl. 0,2 Best.-Nr.
3 x 50	2,5	45601	45561	45511	45761	45711
	5	45602	45562	45512	45762	45712
	10	45603	45563		45763	
3 x 75	2,5	45605	45565	45515	45765	45715
	5	45606	45566	45516	45766	45716
	10	45607	45567		45767	
3 x 100	2,5	45609	45569	45519	45769	45719
	5	45610	45570	45520	45770	45720
	10	45611	45571		45771	
3 x 150	2,5	45613	45573	45523	45773	45723
	5	45614	45574	45524	45774	45724
	10	45615	45575	45525	45775	45725

		Best.-Nr.
	Schnappbefestigung	–
	Plombierplatte	–

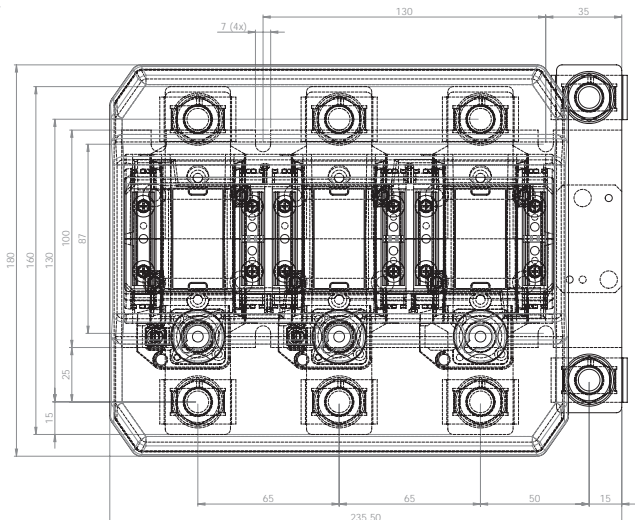
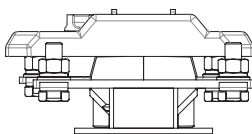
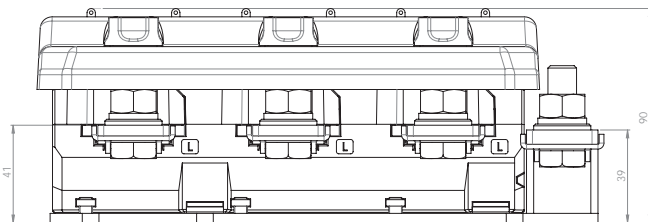



EASKD 31.8 mit Bodenplatte

Dreiphasen-Stromwandlersatz – Verrechnung



Primärstrom [A]	Bürde [VA]	Sekundärstrom [A] / Klasse				
		5 A Kl. 0,5s Best.-Nr.	5 A Kl. 0,5 Best.-Nr.	5 A Kl. 0,2 Best.-Nr.	1 A Kl. 0,5 Best.-Nr.	1 A Kl. 0,2 Best.-Nr.
3 x 200	2,5	46617	46577	46527	46777	46727
	5	46618	46578	46528	46778	46728
	10	46619	46579	46529	46779	46729
3 x 250	2,5	46621	46581	46531	46781	46731
	5	46622	46582	46532	46782	46732
	10	46623	46583	46533	46783	46733
3 x 300	2,5	46625	46585	46535	46785	46735
	5	46626	46586	46536	46786	46736
	10	46627	46587	46537	46787	46737
	15	46628	46588		46788	
3 x 400	2,5	46629	46589	46539	46789	46739
	5	46630	46590	46540	46790	46740
	10	46631	46591	46541	46791	46741
	15	46632	46592	46542	46792	46742
3 x 500	2,5	46633	46593	46543	46793	46743
	5	46634	46594	46544	46794	46744
	10	46635	46595	46545	46795	46745
	15	46636	46596	46546	46796	46746
3 x 600	2,5	46637	46597	46547	46797	46747
	5	46638	46598	46548	46798	46748
	10	46639	46599	46549	46799	46749
	15	46640	46600	46550	46800	46750

		Best.-Nr.
	Schnappbefestigung	–
	Plombierplatte	–

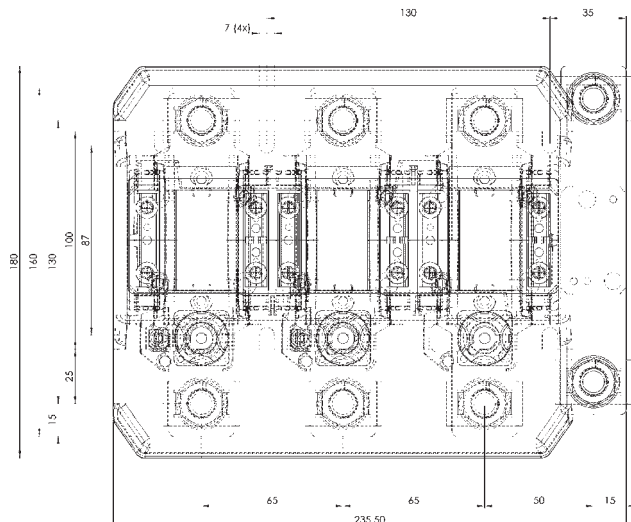
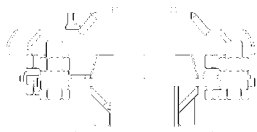
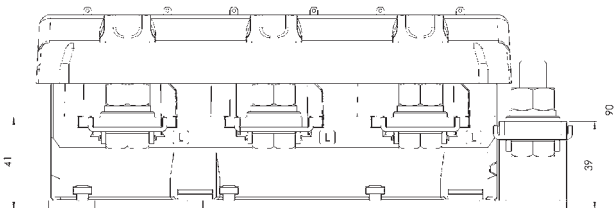

EASR
EASK
EWSK / ESUSK
EASKD / EWSKD



EASKD 31.8 ohne Bodenplatte und Nullleiter

Dreiphasen-Stromwandlersatz – Verrechnung

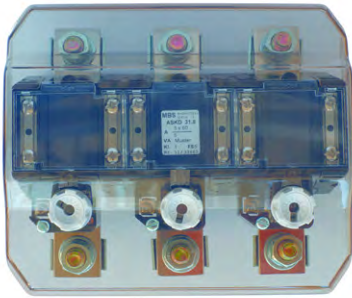

Primärstrom [A]	Bürde [VA]	Sekundärstrom [A] / Klasse				
		5 A Kl. 0,5s Best.-Nr.	5 A Kl. 0,5 Best.-Nr.	5 A Kl. 0,2 Best.-Nr.	1 A Kl. 0,5 Best.-Nr.	1 A Kl. 0,2 Best.-Nr.
3 x 200	2,5	47617	47577	47527	47777	47727
	5	47618	47578	47528	47778	47728
	10	47619	47579	47529	47779	47729
3 x 250	2,5	47621	47581	47531	47781	47731
	5	47622	47582	47532	47782	47732
	10	47623	47583	47533	47783	47733
3 x 300	2,5	47625	47585	47535	47785	47735
	5	47626	47586	47536	47786	47736
	10	47627	47587	47537	47787	47737
	15	47628	47588		47788	
3 x 400	2,5	47629	47589	47539	47789	47739
	5	47630	47590	47540	47790	47740
	10	47631	47591	47541	47791	47741
	15	47632	47592	47542	47792	47742
3 x 500	2,5	47633	47593	47543	47793	47743
	5	47634	47594	47544	47794	47744
	10	47635	47595	47545	47795	47745
	15	47636	47596	47546	47796	47746
3 x 600	2,5	47637	47597	47547	47797	47747
	5	47638	47598	47548	47798	47748
	10	47639	47599	47549	47799	47749
	15	47640	47600	47550	47800	47750

		Best.-Nr.
	Schnappbefestigung	–
	Plombierplatte	–

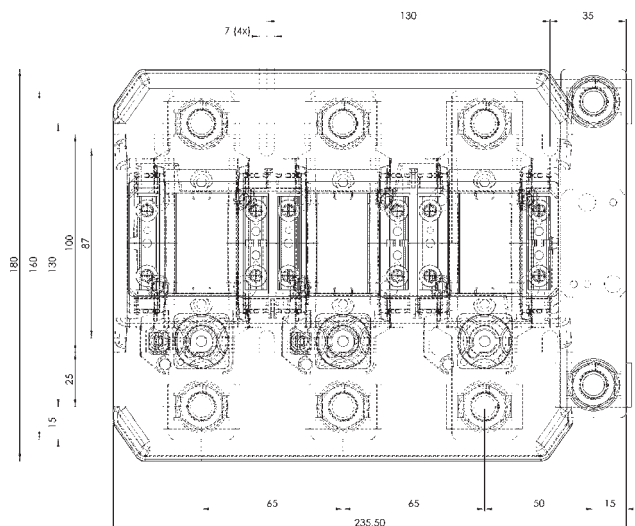
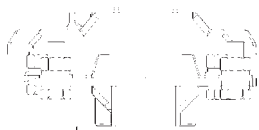
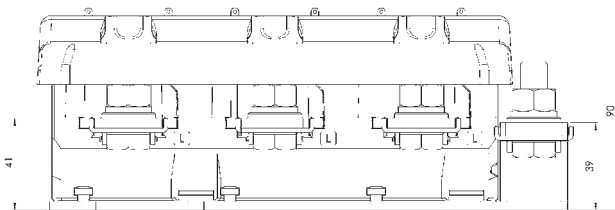



Zubehör für Niederspannungs-Stromwandler

Schnappbefestigung

Schnellbefestigung – Quick Fix

Kupferrohr

Montagewinkel

Spannpratzen + Spannmodul

Montagekit

Verdrehsicherung

Sekundärverschluss

Plombierplatte

Kupferschiene



Schnappbefestigung



Bauform	Einsatz für MBS-Wandlertypen	Best.-Nr.
A	ASR 22.3; ASK 21.3; 31.3; 318.3; 41.3; WSK 30, EASK 31.3, EASR 22.3	53011
B	ASK 31.4, EASK 31.4	54011
C	ASK 31.5; WSK 40 N, EASK 31.5, EASK 41.5	55011
D	ASK 41.4; 412.4; WSK 40, EASK 41.4	55012
E	ASR 14.3; 20.3; 201.3, EASR 14.3, EAS 176.3, EASK 176.3	55013
F	ASR 21.3; ASK 205.3	55014
G	CTB 31.35, 41.35	55015

Quick Fix



Schnellbefestigung	Best.-Nr.
Standard für 85°C Dauertemperatur	55021
Kabelbinder hitzestabilisiert bis 130°C	55024

Kupferrohr



Länge	Außen-Ø	Innen-Ø	Max. Stromstärke	Best.-Nr.
34	22,5	16,5	600 A	52011
36	22,5	16,5	600 A	52012
unterschiedliche Längen auf Anfrage				
34	22,5	12,5	600 A	52021
36	22,5	12,5	600 A	52022
unterschiedliche Längen auf Anfrage				
34	22,5	8,5	600 A	52031
36	22,5	8,5	600 A	52032
unterschiedliche Längen auf Anfrage				
32	21	12,5	600 A	52041
34	21	12,5	600 A	52042
unterschiedliche Längen auf Anfrage				
32	21	8,5	600 A	52051
34	21	8,5	600 A	52052
unterschiedliche Längen auf Anfrage				

Montagewinkel für Dreiphasen-Stromwandlersatz



Montagewinkel für Dreiersatz (2 Stück) Aufsteck-, Schutz- und Verrechnungs-Stromwandler	
Einsatz für MBS-Stromwandlertypen	Best.-Nr.
ASK 421.4; 41.4; 412.4; WSK 40; WSK 40N	59037
ASK 41.5	59082

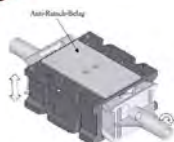

Spannpratzen + Spannmodul

	Best.-Nr.
Flexible Schienenbefestigung für Typen ASK 165.5 und ASK 205.5	59090
Spannmodul mit Anti-Rutsch-Belag	59091



Montagekit



Schraube M 12 x 40	Best.-Nr.
mit Spannungsabgriff M5	59026
mit Spannungsabgriff M5 und Verdrehsicherung Schiene 30 mm	59027
mit Spannungsabgriff M5 und Verdrehsicherung Schiene 40 mm	59030
mit Spannungsabgriff M5 und Verdrehsicherung Schiene 50 mm	59081
Standard	59028
Standard und Verdrehsicherung Schiene 30 mm	59029
Standard und Verdrehsicherung Schiene 40 mm	59030A
Standard und Verdrehsicherung Schiene 50 mm	59080

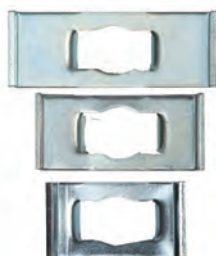

Verdrehsicherung

	Abmessungen [mm]			Best.-Nr.
Cu-Schiene	30 x 6	30 x 8	30 x 10	59035
Cu-Schiene	40 x 6	40 x 8	40 x 10	59036
Cu-Schiene	50 x 6	50 x 8	50 x 10	59048



Sekundärverschluss

	Best.-Nr.
Universal-Sekundärverschluss für MBS-Stromwandler	53016

Plombierplatte



Bauform	Einsatz für MBS-Stromwandlertypen	Best.-Nr.
Form A	ASR 22.3, ASK 21.3, 31.3, 318.3, 41.3, 103.3(2x), 123.3(2x), WSK 30, SASR22.3, SASK21.3, ASK(D) 21.3, EASR 22.3, EASK 21.3, EASK 31.3, EASK 123.3, EASK(D) 21.3	59040
Form B	ASK 31.4, 31.5, 421.4, 41.4, 412.4, WSK 40, WSK 40N, 60, 70.6 N, KSU, SUSK 3...8 primär, SASK 31.5, SASK 421.4, SASK 41.4, ASK(D) 31.5, ASK(D) 31.5 2U, EASK 31.4, EASK 31.5	59041
Form C	ASK 541.4, 51.4, 561.4, 61.4, 63.4, 63.6, 81.4, 101.4, ASK 105.6, 105.6N, 127.4, 127.6, 128.4, ASK 105.6, 105.6N, 127.4, 127.6, 128.4, 129.10, SUSK 3...8 sekundär, SASK 541.4, SASK 61.4, SASK 63.6, SASK 105.6, EASK 541.4, EASK 51.4, EASK 51.4 2U, EASK 61.4, EASK 63.6, EASK 81.4, EASK 105.6, ESUSK 2...8	59042
Form D	WSK 70.6	59043
Form E	ASK 31.6, 41.6, 51.6, 61.6, SASK 31.6, SASK 41.6, SASK 51.6, SASK 61.6, EASK 31.6, EASK 41.6, EASK 51.6, EASK 61.6	59044
Form F	WSK 31.5, EWSK 31.5	59045
Form G	CTB 31.35; 41.35	59057
Form H	CTB 51.35	59058
Form J	CTB 61.35; 81.35; 101.35	59059



Kupferschiene

galvanisch vernickelt

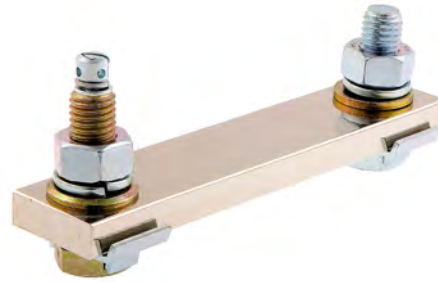
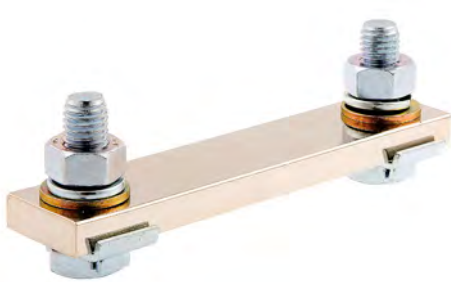

Kupferschiene für Industrie-Stromwandler

Kupferschiene für Verrechnungs-Stromwandler

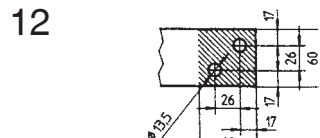
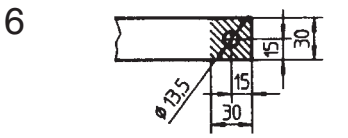
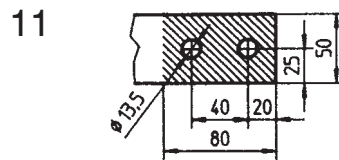
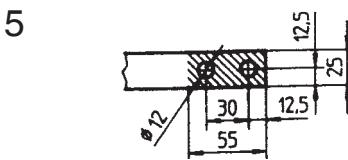
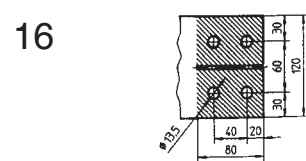
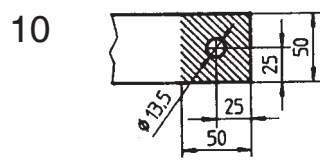
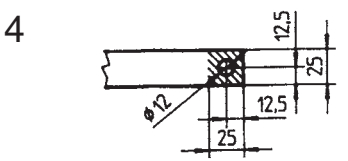
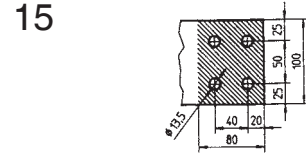
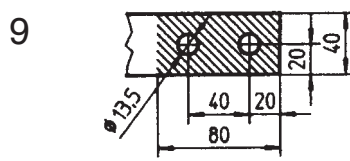
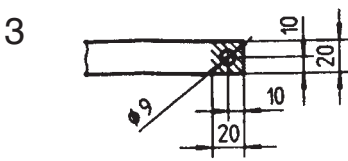
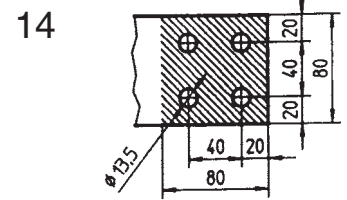
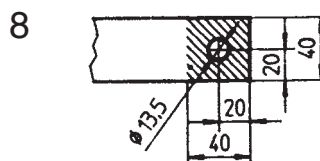
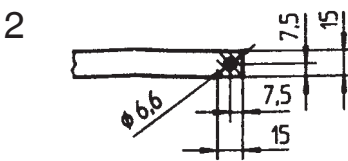
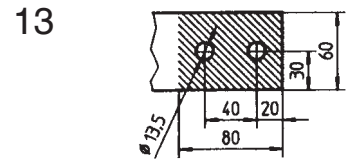
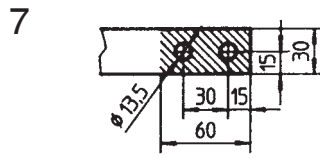
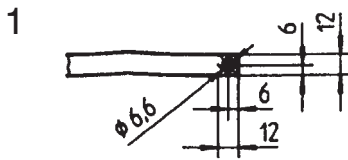

Werkstoff E-Cu-ziehhart
gezogen nach DIN 46433



Kupferschiene

Bestellnummer	Ausführung	Bohrbild	Länge	Breite	Stärke	Max. Stromstärke
020060170B003IO	o. Schrauben	3	170	20	6	300 A
030060130B006I	Industrie	6	130	30	6	300 A
030060130B006E	EVU	6	130	30	6	300 A
030060130B006IO	o. Schrauben	6	130	30	6	300 A
030060140B006I	Industrie	6	140	30	6	300 A
030060140B006E	EVU	6	140	30	6	300 A
030060140B006IO	o. Schrauben	6	140	30	6	300 A
030080130B006I	Industrie	6	130	30	8	400 A
030080130B006E	EVU	6	130	30	8	400 A
030080130B006IO	o. Schrauben	6	130	30	8	400 A
030080160B006I	Industrie	6	160	30	8	400 A
030080160B006E	EVU	6	160	30	8	400 A
030080160B006IO	o. Schrauben	6	160	30	8	400 A
030100130B006I	Industrie	6	130	30	10	750 A
030100130B006E	EVU	6	130	30	10	750 A
030100130B006IO	o. Schrauben	6	130	30	10	750 A
030100140B006I	Industrie	6	140	30	10	750 A
030100140B006E	EVU	6	140	30	10	750 A
030100140B006IO	o. Schrauben	6	140	30	10	750 A
030100160B006I	Industrie	6	160	30	10	750 A
030100160B006E	EVU	6	160	30	10	750 A
030100160B006IO	o. Schrauben	6	160	30	10	750 A
040060140B008I	Industrie	8	140	40	6	500 A
040060140B008E	EVU	8	140	40	6	500 A
040060140B008IO	o. Schrauben	8	140	40	6	500 A
040060160B008I	Industrie	8	160	40	6	500 A
040060160B008E	EVU	8	160	40	6	500 A
040060160B008IO	o. Schrauben	8	160	40	6	500 A
040100140B008I	Industrie	8	140	40	10	800 A
040100140B008E	EVU	8	140	40	10	800 A
040100140B008IO	o. Schrauben	8	140	40	10	800 A
040100160B008I	Industrie	8	160	40	10	800 A
040100160B008E	EVU	8	160	40	10	800 A
040100160B008IO	o. Schrauben	8	160	40	10	800 A
050100140B010I	Industrie	10	140	50	10	1000 A
050100140B010E	EVU	10	140	50	10	1000 A
050100140B010IO	o. Schrauben	10	140	50	10	1000 A
050100180B010I	Industrie	10	180	50	10	1000 A
050100180B010E	EVU	10	180	50	10	1000 A
050100180B010IO	o. Schrauben	10	180	50	10	1000 A
050100220B011I	Industrie	11	220	50	10	1000 A
050100220B011E	EVU	11	220	50	10	1000 A
050100220B011IO	o. Schrauben	11	220	50	10	1000 A
060100180B012I	Industrie	12	180	60	10	1200 A
060100180B012E	EVU	12	180	60	10	1200 A
060100180B012IO	o. Schrauben	12	180	60	10	1200 A
060100220B013I	Industrie	13	220	60	10	1200 A
060100220B013E	EVU	13	220	60	10	1200 A
060100220B013IO	o. Schrauben	13	220	60	10	1200 A
080100240B014I	Industrie	14	240	80	10	1500 A
080100240B014E	EVU	14	240	80	10	1500 A
080100240B014IO	o. Schrauben	14	240	80	10	1500 A
100100240B015I	Industrie	15	240	100	10	2000 A
100100240B015E	EVU	15	240	100	10	2000 A
100100240B015IO	o. Schrauben	15	240	100	10	2000 A

Primärschienen-Lieferumfang:

EVU = mit je 1-mal Montagekit 59026 und 59028

Industrie = mit je 2-mal Montagekit 59028

o. Schrauben = ohne Schrauben

Sonderlängen und Sonder-Bohrbilder auf Anfrage lieferbar

Schnapp-
befestigung

Kupferrohr

Montagewinkel

Montagekit

Sekundär-
verschlussVerdreh-
sicherung

Plombierplatte

Kupferschiene





Noch keine passende Wandler-Lösung gefunden? Fragen Sie uns!

MBS entwickelt und fertigt ein umfangreiches Sortiment individueller, kundenspezifischer Sonderlösungen an Niederspannungsstromwandlern und Schutzstromwandlern.

Die Realisierung aller von MBS angebotenen Sonderlösungen erfolgt unter Beachtung der jeweils gültigen technischen Normen.

Ein geschultes Team erfahrener Mitarbeiter steht bereit, um Sie bei der Suche und Realisierung, speziell auf Sie zugeschnittener Lösungen, zu unterstützen.

Fragen Sie uns!



Zur Bearbeitung Ihrer Anfragen bitten wir um Übermittlung folgender Angaben:

- Übersetzungsverhältnis (I_P / I_S [A])
- Benötigte Nennleistung [VA]
- Benötigte Genauigkeitsklasse
Messwandler: Kl. 0,2s / 0,2 / 0,5s / 0,5 / 1 / 3
Schutzstromwandler: Kl. 5P / 10P / PX
- Thermischer Nennkurzzeitstrom
- größtes zulässiges Außenmaß [mm]
- kleinstes zulässiges Innenmaß (bei Primärleiterdurchführungen) [mm]
- maximale Bautiefe [mm]



MBS AG





Stromschienen-Isolatoren/-Halter

DB/P **Zwischenraum-Isolatoren**
CO/P
CS/P
CT/P
CPE

PI/P **Durchgangs-Isolatoren**

PSB **Vertikaler Schienenhalter**

GB **Befestigungsmaterial**
Gewindebolzen

SK **Sechskantabstandhalter in Messing**

Schienenhalter **Schienenhalter L**
Schienenhalter Z



Zwischenraum-Isolatoren

Typ DB/P

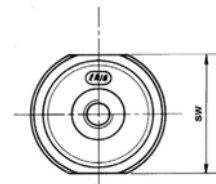
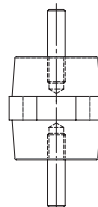
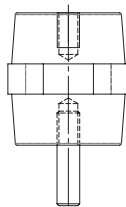
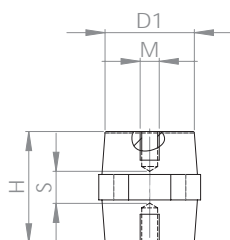

Aus Polyglas-Polyestermasse, mit Glasfaser verstärkt, rot, selbstverlöschend.

Die Isolatoren Typ DB, unzerbrechlich und mit sehr guten elektrischen und mechanischen Eigenschaften, können selbst unter schwierigen Arbeitsbedingungen eingesetzt werden, wie z.B. bei hohen Raumtemperaturen, in Kontakt mit ätzenden Substanzen, bei Vibrationen, usw.

Die als Sechskant ausgebildete Mittelschicht mit zwei gegenüberliegenden Seiten erleichtert das Haften und Einrasten des Isolators.

Auf Wunsch können die Isolatoren auch in folgenden Ausführungen geliefert werden:

- Mit einem nicht in der Massenproduktion üblichen Gewinde
- Mit einem oder zwei Gewindebolzen „GB“

Siehe Seite 283

Betriebstemperatur: $-40\text{ °C} < T < +130\text{ °C}$

Brandverhalten: UL94-V0

Best.-Nr. XXXXX
z. B. 90015

Best.-Nr. XXXXX-1
z. B. 90015-1

Best.-Nr. XXXXX-2
z. B. 90015-2

Best.-Nr.	Typ	H [mm]	sw [mm]	D1 [mm]	U_M [V]	M	GW-Tiefe [mm]	Farbe	VPE [Stk.]
90015	DB/P 12	12	11	10	220	M3	3	schwarz	100
90018	DB/P 12	12	11	10	220	M4	3	rot	100
90022	DB/P 16	16	14	13	380	M4	4	rot	100
90025	DB/P 20	20	17	15	500	M4	6	rot	100
90026	DB/P 20	20	17	15	500	M6	6	rot	100
90028	DB/P 25	25	19	15	600	M6	7	schwarz	250
90029	DB/P 25	25	19	15	600	M5	7	rot	250
90030	DB/P 25	25	19	15	600	M6	7	rot	250
90033	DB/P 30	30	30	26	600	M6	8	rot	80
90034	DB/P 30	30	30	26	600	M8	7	rot	80
90035	DB/P 34	35	32	28	1000	M6	9	rot	64
90036	DB/P 34	35	32	28	1000	M8	10	rot	64
90037	DB/P 34	35	32	28	1000	M10	10	rot	64
90038	DB/P 35	35	41	35	1000	M6	9	rot	36
90039	DB/P 35	35	41	35	1000	M8	9	rot	36
90040	DB/P 35	35	41	35	1000	M10	10	rot	36
90438	DB/P 40	40	40	30	1000	M8	11	rot	100
90439	DB/P 40	40	40	30	1000	M10	12	rot	100
90440	DB/P 40	40	40	30	1000	M12	10	rot	100
90041	DB/P 45	45	41	35	1500	M6	12	rot	27
90042	DB/P 45	45	41	35	1500	M8	12	rot	27
90043	DB/P 45	45	41	35	1500	M10	12	rot	27
90044	DB/P 45	45	41	35	1500	M12	12	rot	27
90046	DB/P 50	50	36	29	2000	M8	12	rot	36
90047	DB/P 50	50	36	29	2000	M10	12	rot	36
90048	DB/P 50	50	36	29	2000	M12	13	rot	36
90441	DB/P 60	60	55	40	2000	M8	20	rot	25
90442	DB/P 60	60	55	40	2000	M10	21	rot	25
90443	DB/P 60	60	55	40	2000	M12	20	rot	25
90050	DB/P 65	63,5	41	35	3000	M8	17	rot	22
90051	DB/P 65	63,5	41	35	3000	M10	19	rot	22
90052	DB/P 65	63,5	41	35	3000	M12	19	rot	22
90053	DB/P 75	76	50	36	5000	M8	19	rot	12
90054	DB/P 75	76	50	36	5000	M10	19	rot	12
90055	DB/P 75	76	50	36	5000	M12	19	rot	12
90057	DB/P 750	75	65	52	5000	M12	18	rot	8
90058	DB/P 750	75	65	52	5000	M16	23	rot	8



Typ	Gewinde	Kriechspan- nungsfestigkeit [kV]	Durchschlag- spannung [kV]	Max. Zugbe- lastbarkeit [kN]	Max. Biege- kraft [kN]	Max. Druck- belastbarkeit [kN]	Max. Anzugs- drehmoment [Nm]
DB/P 16	M4	3	8	1	0,5	5	2,8
DB/P 20	M4	4	15	1,5	0,6	6	2,8
DB/P 20	M6	4	15	1,5	0,6	6	8,9
DB/P 25	M5	7	20	3	1,8	21	5,1
DB/P 25	M6	7	20	3	1,8	21	8,9
DB/P 30	M6	8	23	5	2,5	44	8,9
DB/P 30	M8	8	23	5	2,5	44	21,5
DB/P 34	M6	10	30	8	4,5	65	8,9
DB/P 34	M8	10	30	8	4,5	65	21,5
DB/P 34	M10	10	30	8	4,5	65	43,0
DB/P 35	M6	10	30	11	8	80	8,9
DB/P 35	M8	10	30	11	8	80	21,5
DB/P 45	M6	12	40	12	8	80	8,9
DB/P 45	M8	12	40	12	8	80	21,5
DB/P 45	M10	12	40	12	8	80	43,0
DB/P 45	M12	12	40	12	8	80	85
DB/P 50	M8	12	40	8,5	4,5	68	21,5
DB/P 50	M10	12	40	8,5	4,5	68	43,0
DB/P 50	M12	12	40	8,5	4,5	68	85
DB/P 65	M8	15	40	15	7	83	21,5
DB/P 65	M10	15	40	15	7	83	43,0
DB/P 65	M12	15	40	15	7	83	85
DB/P 75	M8	25	50	23	9	100	21,5
DB/P 75	M10	25	50	23	9	100	43,0
DB/P 75	M12	25	50	23	9	100	85
DB/P 750	M12	25	50	28	15	150	85
DB/P 750	M16	25	50	28	15	150	180,4

Bei den Typen DB..., CO/P..., CS/P..., CT/P..., CPE... wurde eine Prüfung von Isolierstoffen (Durchschlagspannung, Durchschlagfestigkeit und Überschlagspannung bei technischen Frequenzen) nach den Bestimmungen VDE 0303-21 03/1999 / DIN EN 60243-1 03/1999 durchgeführt.

Ermittlung der Durchschlagspannung bzw. Überschlagspannung zwischen zwei ungleichen Elektroden (Durchmesser 25 mm bzw. 75 mm). Die Prüfung wurde bei Normklima 23/50, d. h. (23 ±2) °C und (50 ±5) % relative Luftfeuchtigkeit durchgeführt.

DB/P

CO/P

CS/P

CT/P

CPE

P/P

PSB

GB

SK

Schienenhalter



Zwischenraum-Isolatoren

Typ DB/P

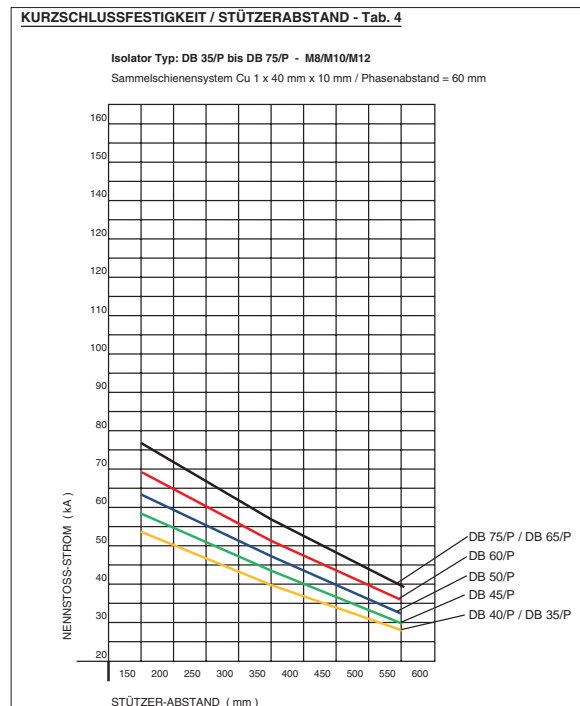
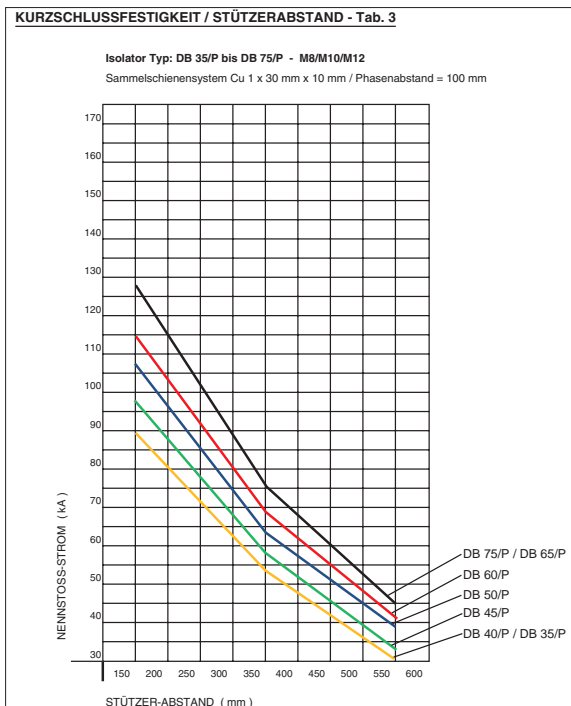
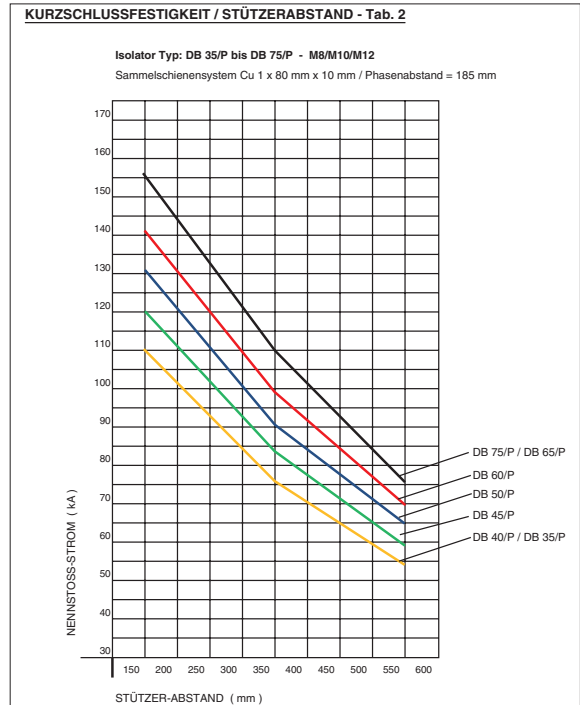
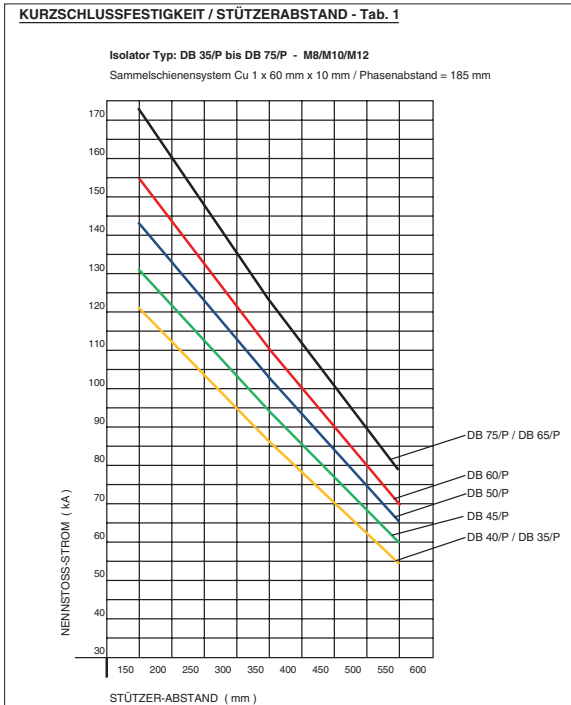



Zwischenraum-Isolatoren

Typ CO/P

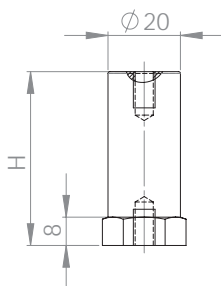

Aus Polyglas-Polyestermasse, mit Glasfaser verstärkt, rot, selbstverlöschend.

Auf Anfrage können die Isolatoren vom Typ CO/P mit einem oder zwei Gewindebolzen bestückt geliefert werden. Zur Selbstsicherung sind diese Gewindebolzen mit Loctite befestigt.

Betriebstemperatur: $-40\text{ °C} < T < +130\text{ °C}$

Brandverhalten: UL94-V0

Best.-Nr.	Typ	H [mm]	sw [mm]	D1 [mm]	U_M [V]	M	GW-Tiefe [mm]	VPE [Stk.]
90061	CO/P 16	16	21	20	220	M4	4	200
90062	CO/P 16	16	21	20	220	M5	4	200
90063	CO/P 16	16	21	20	220	M6	4	100
90064	CO/P 16	16	21	20	220	M8	4	150
90065	CO/P 20	20	21	20	400	M5	5	200
90066	CO/P 20	20	21	20	400	M6	5	100
90067	CO/P 20	20	21	20	400	M8	5	200
90068	CO/P 25	25	21	20	500	M5	6	150
90069	CO/P 25	25	21	20	500	M6	6	150
90070	CO/P 25	25	21	20	500	M8	6	150
90071	CO/P 30	30	21	20	600	M5	7	140
90072	CO/P 30	30	21	20	600	M6	7	140
90073	CO/P 30	30	21	20	600	M8	7	140
90075	CO/P 35	35	21	20	600	M6	7	120
90077	CO/P 40	40	21	20	600	M6	9	110
90078	CO/P 40	40	21	20	600	M8	10	110
90079	CO/P 45	45	21	20	750	M6	9	100
90080	CO/P 45	45	21	20	750	M8	10	100
90081	CO/P 50	50	21	20	750	M6	10	80
90082	CO/P 50	50	21	20	750	M8	10	80
90083	CO/P 60	60	21	20	750	M6	9	70
90084	CO/P 60	60	21	20	750	M8	9	70

Typ	Kriechspannungsfestigkeit [kV]	Durchschlagspannung [kV]	Max. Zugbelastbarkeit [kN]	Max. Biegekraft [kN]	Max. Druckbelastbarkeit [kN]	Max. Anzugsdrehmoment [Nm]
CO/P 30	5	15	4	2	21	5,9 (M5) ... 21,5 (M8)
CO/P 40	8	20	4	1,5	21	8,9 (M6) ... 21,5 (M8)
CO/P 50	10	25	4	1	21	8,9 (M6) ... 21,5 (M8)
CO/P 60	10	30	4	1	21	8,9 (M6) ... 21,5 (M8)

Bei den Typen DB..., CO/P..., CS/P..., CT/P..., CPE... wurde eine Prüfung von Isolierstoffen (Durchschlagspannung, Durchschlagfestigkeit und Überschlagnspannung bei technischen Frequenzen) nach den Bestimmungen VDE 0303-21 03/1999 / DIN EN 60243-1 03/1999 durchgeführt.

Ermittlung der Durchschlagspannung bzw. Überschlagnspannung zwischen zwei ungleichen Elektroden (Durchmesser 25 mm bzw. 75 mm). Die Prüfung wurde bei Normklima 23/50, d. h. $(23 \pm 2)\text{ °C}$ und $(50 \pm 5)\%$ relative Luftfeuchtigkeit durchgeführt.



Zwischenraum-Isolatoren

Typ CS/P

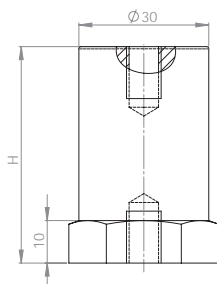

Aus Polyglas-Polyestermasse,
mit Glasfaser verstärkt, rot,
selbstverlöschend

Betriebstemperatur: $-40\text{ °C} < T < +130\text{ °C}$

Brandverhalten: UL94-V0

Best.-Nr.	Typ	H [mm]	sw [mm]	D1 [mm]	U_M [V]	M	GW-Tiefe [mm]	VPE [Stk.]
90087	CS/P 30	30	30	30	750	M6	9	80
90088	CS/P 30	30	30	30	750	M8	9	80
90089	CS/P 30	30	30	30	750	M10	9	80
90090	CS/P 35	35	30	30	1000	M6	9	64
90091	CS/P 35	35	30	30	1000	M8	9	64
90092	CS/P 35	35	30	30	1000	M10	9	64
90093	CS/P 40	40	30	30	1000	M6	12	60
90094	CS/P 40	40	30	30	1000	M8	12	60
90095	CS/P 40	40	30	30	1000	M10	12	60
90096	CS/P 45	45	30	30	1000	M6	12	48
90097	CS/P 45	45	30	30	1000	M8	12	48
90098	CS/P 45	45	30	30	1000	M10	13	48
90099	CS/P 50	50	30	30	1500	M6	12	48
90100	CS/P 50	50	30	30	1500	M8	13	48
90101	CS/P 50	50	30	30	1500	M10	12	48
90102	CS/P 55	55	30	30	1500	M6	12	40
90103	CS/P 55	55	30	30	1500	M8	11	40
90105	CS/P 60	60	30	30	1500	M6	12	40
90106	CS/P 60	60	30	30	1500	M8	16	40
90107	CS/P 60	60	30	30	1500	M10	20	40
90109	CS/P 65	65	30	30	1500	M8	18	32
90111	CS/P 70	70	30	30	1500	M6	14	32
90112	CS/P 70	70	30	30	1500	M8	18	32
90113	CS/P 70	70	30	30	1500	M10	18	32

Typ	Kriechspannungs- festigkeit [kV]	Durchschlag- spannung [kV]	Max. Zug- belastbarkeit [kN]	Max. Biege- kraft [kN]	Max. Druck- belastbarkeit [kN]	Max. Anzugsdreh- moment [Nm]
CS/P 30	8	20	9	4,5	40	8,9 (M6) ... 43 (M10)
CS/P 40	8	25	9	3	40	8,9 (M6) ... 43 (M10)
CS/P 50	10	35	9	2	40	8,9 (M6) ... 43 (M10)
CS/P 60	15	35	9	1,5	40	8,9 (M6) ... 43 (M10)

Bei den Typen DB..., CO/P..., CS/P..., CT/P..., CPE... wurde eine Prüfung von Isolierstoffen (Durchschlagspannung, Durchschlagfestigkeit und Überschlagspannung bei technischen Frequenzen) nach den Bestimmungen VDE 0303-21 03/1999 / DIN EN 60243-1 03/1999 durchgeführt.

Ermittlung der Durchschlagspannung bzw. Überschlagspannung zwischen zwei ungleichen Elektroden (Durchmesser 25 mm bzw. 75 mm). Die Prüfung wurde bei Normklima 23/50, d. h. $(23 \pm 2)\text{ °C}$ und $(50 \pm 5)\%$ relative Luftfeuchtigkeit durchgeführt.



Zwischenraum-Isolatoren

Typ CT/P

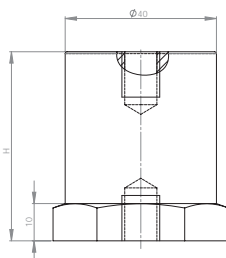

Aus Polyglas-Polyestermasse,
mit Glasfaser verstärkt, rot,
selbstverlöschend

Betriebstemperatur: $-40\text{ °C} < T < +130\text{ °C}$

Brandverhalten: UL94-V0

Best.-Nr.	Typ	H [mm]	sw [mm]	D1 [mm]	U_M [V]	M	GW-Tiefe [mm]	VPE [Stk.]
90118	CT/P 30	30	41	40	750	M8	8	45
90119	CT/P 30	30	41	40	750	M10	9	45
90120	CT/P 35	35	41	40	750	M8	9	36
90121	CT/P 35	35	41	40	750	M10	9	36
90122	CT/P 40	40	41	40	1000	M8	12	27
90123	CT/P 40	40	41	40	1000	M10	12	27
90123M12	CT/P 40	40	41	40	1000	M12	12	27
90124	CT/P 45	45	41	40	1000	M8	13	27
90125	CT/P 45	45	41	40	1000	M10	12	27
90126	CT/P 50	50	41	40	1500	M8	12	27
90127	CT/P 50	50	41	40	1500	M10	13	27
90127M12	CT/P 50	50	41	40	1500	M12	11	27
90129	CT/P 55	55	41	40	1500	M10	12	18
90130	CT/P 60	60	41	40	1500	M8	18	18
90131	CT/P 60	60	41	40	1500	M10	18	18
90131M12	CT/P 60	60	41	40	1500	M12	18	18
90133	CT/P 65	65	41	40	1500	M10	18	18
90134	CT/P 70	70	41	40	1500	M8	18	18
90135	CT/P 70	70	41	40	1500	M10	18	18

Typ	Kriechspannungsfestigkeit [kV]	Durchschlagspannung [kV]	Max. Zugbelastbarkeit [kN]	Max. Biegekraft [kN]	Max. Druckbelastbarkeit [kN]	Max. Anzugsdrehmoment [Nm]
CT/P 30	8	20	10	7,5	80	21,5
CT/P 30	8	20	10	7,5	80	43
CT/P 40	10	25	10	7	80	21,5
CT/P 40	10	25	10	7	80	43
CT/P 40	10	25	10	7	80	73,8
CT/P 50	10	35	10	5	80	21,5
CT/P 50	10	35	10	5	80	43
CT/P 50	10	35	10	5	80	73,8
CT/P 60	10	35	10	3,7	80	21,5
CT/P 60	10	35	10	3,7	80	43
CT/P 60	10	35	10	3,7	80	73,8

Bei den Typen DB..., CO/P..., CS/P..., CT/P..., CPE... wurde eine Prüfung von Isolierstoffen (Durchschlagspannung, Durchschlagfestigkeit und Überschlagspannung bei technischen Frequenzen) nach den Bestimmungen VDE 0303-21 03/1999 / DIN EN 60243-1 03/1999 durchgeführt.

Ermittlung der Durchschlagspannung bzw. Überschlagspannung zwischen zwei ungleichen Elektroden (Durchmesser 25 mm bzw. 75 mm). Die Prüfung wurde bei Normklima 23/50, d. h. $(23 \pm 2)\text{ °C}$ und $(50 \pm 5)\%$ relative Luftfeuchtigkeit durchgeführt.



Zwischenraum-Isolatoren

Typ CPE

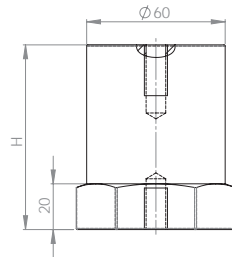

Aus Polyglas-Polyestermasse,
mit Glasfaser verstärkt, rot,
selbstverlöschend

Betriebstemperatur: $-40\text{ °C} < T < +130\text{ °C}$

Brandverhalten: UL94-V0

Best.-Nr.	Typ	H [mm]	sw [mm]	D1 [mm]	U_M [V]	M	GW-Tiefe [mm]	VPE [Stk.]
90140	CPE 40	40	60	60	1500	M10	11	12
90141	CPE 40	40	60	60	1500	M12	11	12
90142	CPE 40	40	60	60	1500	M16	12	12
90143	CPE 60	60	60	60	3000	M10	18	10
90144	CPE 60	60	60	60	3000	M12	18	10
90145	CPE 60	60	60	60	3000	M16	19	10
90146	CPE 80	80	60	60	5000	M10	19	8
90147	CPE 80	80	60	60	5000	M12	19	8
90148	CPE 80	80	60	60	5000	M16	23	8
90149	CPE 100	100	60	60	8000	M10	19	5
90150	CPE 100	100	60	60	8000	M12	19	5
90151	CPE 100	100	60	60	8000	M16	23	5

Typ	Kriechspannungsfestigkeit [kV]	Durchschlagspannung [kV]	Max. Zugbelastbarkeit [kN]	Max. Biegekraft [kN]	Max. Druckbelastbarkeit [kN]	Max. Anzugsdrehmoment [Nm]
CPE 40	10	25	11	7	100	43 (M10) ... 180,4 (M16)
CPE 60	20	50	15	5	100	43 (M10) ... 180,4 (M16)
CPE 80	25	50	23	9	120	43 (M10) ... 180,4 (M16)
CPE 100	30	50	30	15	150	43 (M10) ... 180,4 (M16)

Bei den Typen DB..., CO/P..., CS/P..., CT/P..., CPE... wurde eine Prüfung von Isolierstoffen (Durchschlagspannung, Durchschlagfestigkeit und Überschlagspannung bei technischen Frequenzen) nach den Bestimmungen VDE 0303-21 03/1999 / DIN EN 60243-1 03/1999 durchgeführt.

Ermittlung der Durchschlagspannung bzw. Überschlagspannung zwischen zwei ungleichen Elektroden (Durchmesser 25 mm bzw. 75 mm). Die Prüfung wurde bei Normklima 23/50, d. h. $(23 \pm 2)\text{ °C}$ und $(50 \pm 5)\%$ relative Luftfeuchtigkeit durchgeführt.





Durchgangs-Isolator Typ PI/P

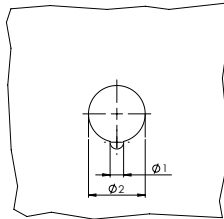

Verkleidungsbohrung

Vertikaler Schienenhalter Typ PSB

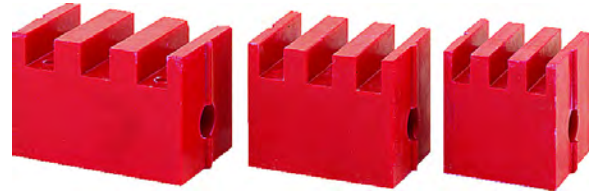

Best.-Nr.	Verpack.-Einheit	Artikel-Gruppe	Artikel	H (mm)	D (mm)	Betriebsspannung	M (Gewinde)
90166	60	PI/P	4	50	15	600	M4
90167	40	PI/P	6	65	22	1000	M6
90168	25	PI/P	8	80	25	1000	M8
90169	20	PI/P	10	95	30	1000	M10
90170	15	PI/P	12	105	35	1000	M12
90171	8	PI/P	16	135	43	2000	M16
90172	4	PI/P	20	155	54	2000	M20

Aufgrund seiner Konstruktionseigenschaften ist dieser Schienenhalter selbst für besondere Isolierungs- und mechanische Widerstandsanforderungen geeignet. Für die Montage eines Schienenhalters werden folgende Teile benötigt:

1 oder 2 seitliche Halter, 2 Montageschrauben und die notwendige Blockanzahl, um die benötigten Schienen zu halten

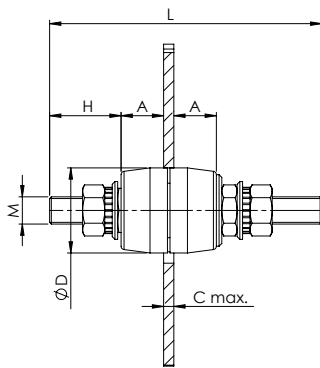

Durchgangs-Isolator Typ PI/P
Polyestermaterial, rot

Best.-Nr.	$\varnothing 1$	$\varnothing 2$	C_{max}
90166	2,0	8,5	2,0
90167	3,0	12,0	3,0
90168	3,0	15,0	4,0
90169	4,0	17,0	4,0
90170	4,5	20,0	4,0
90171	5,0	25,0	8,0
90172	5,5	31,0	10,0

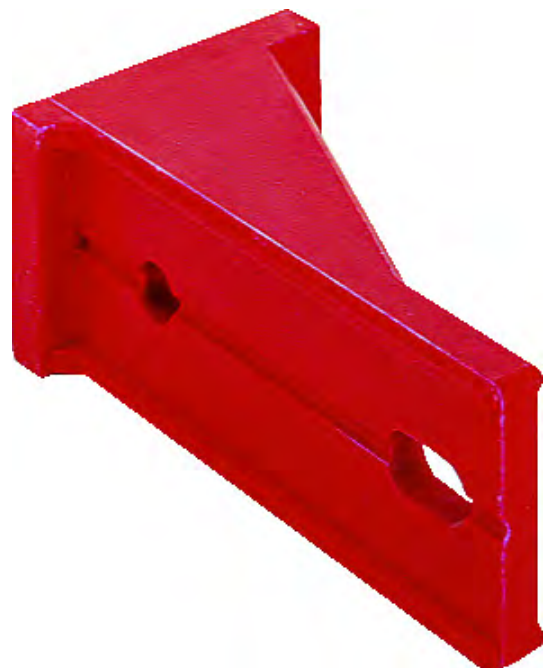



PSB/1

Seitliche Stütze

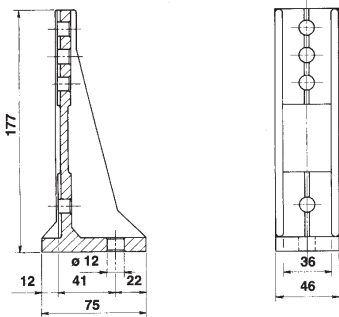

PSB/6

Block für 6-mm-Schiene

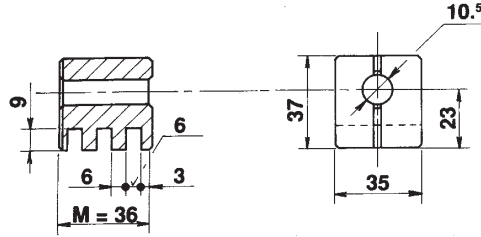

PSB/2

Seitliche Stütze

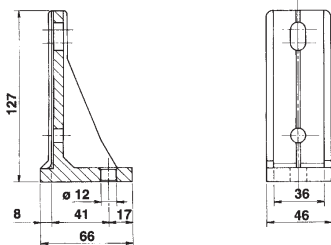

PSB/8

Block für 8-mm-Schiene

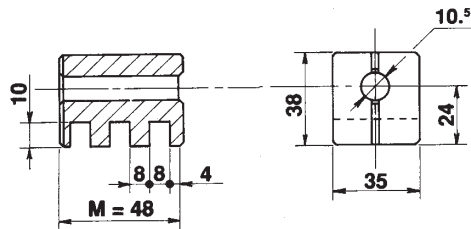

PSB/120

Seitliche Stütze

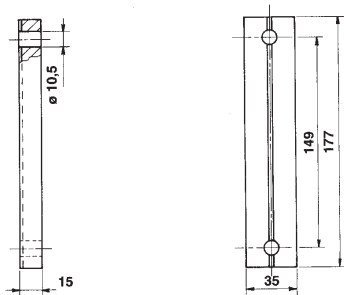

PSB/10

Block für 10-mm-Schiene

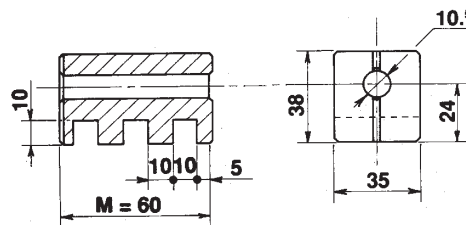

seitliche Stütze	Blöcke	Schiene			Best.-Nr.
PSB/1	PSB 6	60 x 6	80 x 6	100 x 6	90175
	PSB 8	60 x 8	80 x 8	100 x 8	
	PSB 10	60 x 10	80 x 10	100 x 10	
PSB/2	PSB 6	40 x 6	50 x 6		90176
	PSB 8	40 x 8	50 x 8		
	PSB 10	40 x 10	50 x 10		
PSB/120	PSB 6	120 x 6			90177
	PSB 8	120 x 8			
	PSB 10	120 x 10			

Elastische Abweichung der Zähne mit beginnendem Reißen			Verp.	Best.-Nr.
PSB/6	kg	950	36	90178
PSB/8	kg	1130	30	90179
PSB/10	kg	1375	24	90180

Betriebsspannung 1000 V
Betriebstemperatur -40 °C ≤ q ≤ +130 °C
Brandverhalten Klasse: UL94-VO

Kurzschlussfestigkeit der vertikalen Schienenhalter Typ PSB

Schienehalter Typ	Aufbau gemäß Abbildung	CU-Schiene je Phase	Phasen-Mitten-Abstand (mm)	Stützweite (mm)	Nennstoßstrom I _{pk} (kA)	Kurzzeitstromfestigkeit (kA/1 sek)
PSB / 1	1B	3 x 100 mm x 10 mm	185	400	143	65
PSB / 1	1B	3 x 100 mm x 10 mm	185	300	154	70
PSB / 1	5	3 x 100 mm x 10 mm	120	300	220	100
PSB / 1 plus PSB / 120	1B	3 x 120 mm x 10 mm	185	300	176	80
PSB / 1 plus PSB / 120	5	3 x 120 mm x 10 mm	185	300	264	120



Vertikaler Schienenhalter Typ PSB

Abbildung 1

Beispiel eines unipolaren Schienenhalters mit 3 parallelen Schienenhaltern

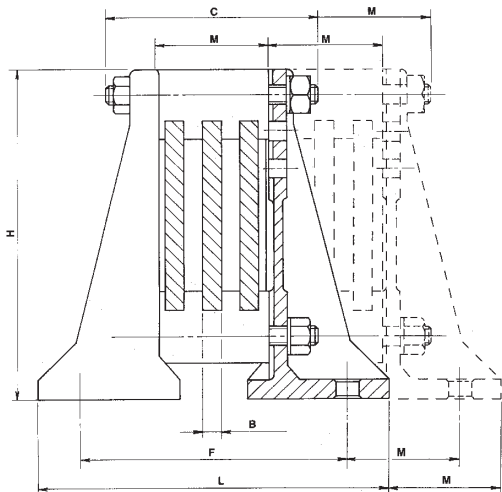

A = Anzahl der Blöcke L = Äußerer Raumbedarf
 B = Schienendicke H = Höhe
 C = Länge der M = Module
 Montageschraube

Abbildungen 1–2–3–4–5–6
 zeigen einige der möglichen Varianten
 Abbildungen bis max. 10 x 100 mm

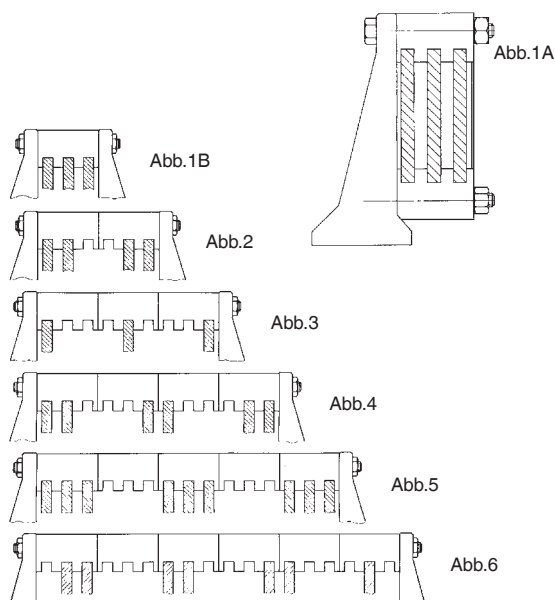

H. Mit seitlicher Stütze PSB/1 = 177 mm
 PSB/2 = 127 mm
 M. Mit Block PSB/6 = 36 mm
 PSB/8 = 48 mm
 PSB/10 = 60 mm

Best.-Nr.	Verpack.-Einheit	Artikel-Gruppe	H (mm)	B (mm)	Betriebsspannung	für Gewinde
90175	96	PSB/1	177	46	1000	M10
90176	144	PSB/2	127	46	1000	M10
90177	244	PSB/120	177	35	1000	M10
90178	36	PSB/6	37	36	1000	M10
90179	30	PSB/8	38	48	1000	M10
90180	24	PSB/10	38	60	1000	M10

Best.-Nr.	Verpack.-Einheit	Artikel-Gruppe	Abbildung	H (mm)	L (mm)	Betriebsspannung	für Gewinde	B
90187		PSB	Abb. 1A	177		1000	M10	6
90188		PSB	Abb. 1A	177		1000	M10	8
90189		PSB	Abb. 1A	177		1000	M10	10
90190		PSB	Abb. 1B	177	162	1000	M10	6
90191		PSB	Abb. 1B	177	174	1000	M10	8
90192		PSB	Abb. 1B	177	186	1000	M10	10
90193		PSB	Abb. 2	177	198	1000	M10	6
90194		PSB	Abb. 2	177	222	1000	M10	8
90195		PSB	Abb. 2	177	246	1000	M10	10
90196		PSB	Abb. 3	177	234	1000	M10	6
90197		PSB	Abb. 3	177	270	1000	M10	8
90198		PSB	Abb. 3	177	306	1000	M10	10
90199		PSB	Abb. 4	177	270	1000	M10	6
90200		PSB	Abb. 4	177	318	1000	M10	8
90201		PSB	Abb. 4	177	366	1000	M10	10
90202		PSB	Abb. 5	177	306	1000	M10	6
90203		PSB	Abb. 5	177	366	1000	M10	8
90204		PSB	Abb. 5	177	426	1000	M10	10
90205		PSB	Abb. 5	177	342	1000	M10	6
90206		PSB	Abb. 5	177	414	1000	M10	8
90207		PSB	Abb. 5	177	486	1000	M10	10
90211		PSB	Abb. 1A	127		1000	M10	6
90212		PSB	Abb. 1A	127		1000	M10	8
90213		PSB	Abb. 1A	127		1000	M10	10
90214		PSB	Abb. 1B	127	152	1000	M10	6
90215		PSB	Abb. 1B	127	164	1000	M10	8
90216		PSB	Abb. 1B	127	176	1000	M10	10
90217		PSB	Abb. 2	127	188	1000	M10	6
90218		PSB	Abb. 2	127	212	1000	M10	8
90219		PSB	Abb. 2	127	236	1000	M10	10
90220		PSB	Abb. 3	127	224	1000	M10	6
90221		PSB	Abb. 3	127	260	1000	M10	8
90222		PSB	Abb. 3	127	296	1000	M10	10
90223		PSB	Abb. 4	127	260	1000	M10	6
90224		PSB	Abb. 4	127	308	1000	M10	8
90225		PSB	Abb. 4	127	356	1000	M10	10
90226		PSB	Abb. 5	127	296	1000	M10	6
90227		PSB	Abb. 5	127	356	1000	M10	8
90228		PSB	Abb. 5	127	416	1000	M10	10
90229		PSB	Abb. 6	127	332	1000	M10	6
90230		PSB	Abb. 6	127	404	1000	M10	8
90231		PSB	Abb. 6	127	476	1000	M10	10

Die o.a. Daten haben rein informativen Charakter und gewähren keine Garantie. Der Kunde ist daher gebeten, von Fall zu Fall zu überprüfen, ob sich das Produkt für die jeweilige Anwendung eignet.

Auf Anfrage können auch gefräste Schienenhalter und andere aus GPO-3-Barren gewonnene Details nach Zeichnung geliefert werden.

Typgeprüft gemäß IEC 61439-2: 2011-08, EN 61439-2: 2012-06 mit praxisnahen Sicherheitsabständen und Stützweiten.



Befestigungsmaterial/Gewindebolzen

GB Gewindebolzen

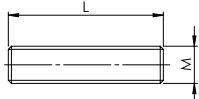

Best.-Nr.	Verpack.-Einheit	Artikel-Gruppe	Gewinde M	Länge L (mm)
90270	100	GB	M3	12
90271	100	GB	M3	15
90272	100	GB	M4	15
90273	100	GB	M4	16
90274	100	GB	M4	18
90275	100	GB	M4	20
90276	100	GB	M5	20
90277	100	GB	M5	22
90278	100	GB	M5	27
90279	100	GB	M5	30
90280	100	GB	M6	18
90281	100	GB	M6	20
90282	100	GB	M6	25
90283	100	GB	M6	27
90284	100	GB	M6	33
90285	100	GB	M6	35
90286	100	GB	M8	20
90287	100	GB	M8	23
90288	100	GB	M8	25
90289	100	GB	M8	30
90290	100	GB	M8	33
90291	100	GB	M8	35
90292	100	GB	M8	38
90293	100	GB	M8	50
90294	100	GB	M10	30
90295	100	GB	M10	35
90296	100	GB	M10	38
90297	100	GB	M10	40
90298	100	GB	M10	45
90299	100	GB	M10	50
90300	100	GB	M12	30
90301	100	GB	M12	50
90326	100	GB	M16	40
90327	100	GB	M16	60

Sechskantschraube M10 mit Mutter und Unterlegscheibe

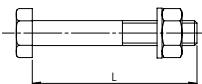

Best.-Nr.	Verpack.-Einheit	Artikel-Gruppe	Gewinde M	Länge L (mm)
90309	100	SKS	M10	60
90310	100	SKS	M10	80
90311	100	SKS	M10	70
90312	100	SKS	M10	90
90313	100	SKS	M10	100
90314	100	SKS	M10	110
90315	100	SKS	M10	140
90316	100	SKS	M10	150
90317	100	SKS	M10	160

Gewindbolzen M10, komplett mit Mutter und Unterlegscheibe

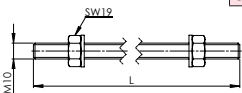

Best.-Nr.	Verpack.-Einheit	Artikel-Gruppe	Gewinde M	Länge L (mm)
90318	100	GB	M10	194
90319	100	GB	M10	230
90320	100	GB	M10	242
90321	100	GB	M10	270
90322	100	GB	M10	290
90323	100	GB	M10	350
90324	100	GB	M10	410
90325	100	GB	M10	1000

Sechskantabstandhalter in Messing

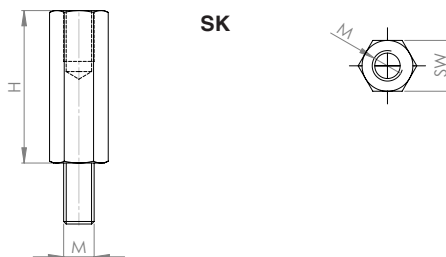

SK

Best.-Nr.	Verpack.-Einheit	Gewinde M	Höhe H (mm)	Schlüsselweite
90330	100	M4	15	7
90331	100	M4	20	7
90332	100	M4	25	7
90333	100	M4	30	7
90334	100	M4	50	7
90335	100	M4	70	7
90336	100	M5	90	7
90337	100	M5	15	8
90338	100	M5	20	8
90339	100	M5	25	8
90340	100	M5	30	8
90341	100	M5	50	8
90342	100	M5	70	8
90343	100	M5	90	8
90344	100	M6	15	10
90345	100	M6	20	10
90346	100	M6	25	10
90347	100	M6	30	10
90348	100	M6	50	10
90349	100	M6	70	10
90350	100	M6	90	10
90351	100	M8	15	13
90352	100	M8	20	13
90353	100	M8	25	13
90354	100	M8	30	13
90355	100	M8	50	13
90356	100	M8	70	13
90357	100	M8	90	13

DB/P

CO/P

CS/P

CT/P

CPE

P/P

PSB

GB

SK

Schienenhalter



Schienerhalter L

Halter L185/1

Best.-Nr. 90392

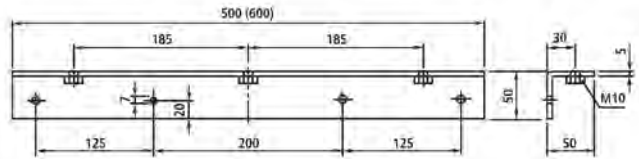

Halter L185/2 (2 x M10 je Phase)

Best.-Nr. 90395

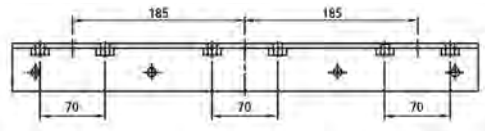

Schienerhalter allgemein

Eigenschaften des Rohmaterials (GFK-Profil, heißgehärtet)

- Temperaturbereich -40 °C bis +130 °C
- Betriebs-Wechselspannung 1000 Volt
- Dauerstrom
 - L/Z 280 mm 2500 A
 - L/Z 500 mm 4000 A
- Phasenabstand
 - L/Z 280 mm 100 mm
 - L/Z 500 mm 185 mm
- Formbeständigkeit DIN 53462 °C > 200
- Rohdichte DIN 53479 gr/cm² ca. 1,7
- Brandverhalten UL 94 HB
- Durchschlagfestigkeit DIN 53481 kV/cm 10
- Kriechstromfestigkeit DIN IEC 112 CTI 600
- Spezifischer Durchgangswiderstand DIN 53482 Ohm x cm 1012

Alle Schienen typgeprüft nach VDE 0660 Teil 500

- Anziehdrehmoment für M10 ca. 4,5 Nm
- Cu-Schiene 10 mm stark aus Kupfer F30 unvernickelt

Typgeprüft gemäß IEC 61439-2: 2011-08, EN 61439-2: 2012-06 mit praxisnahen Sicherungsabständen und Stützweiten.

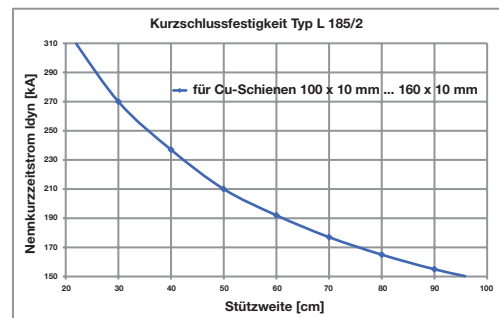
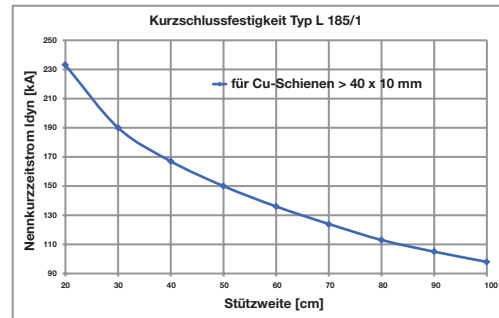
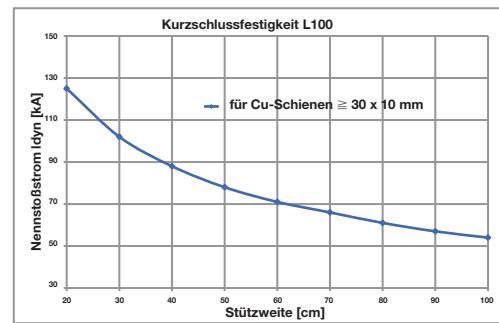

Halter L100

Best.-Nr. 90391

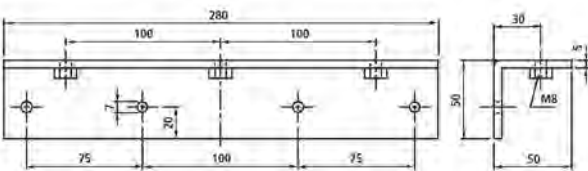

Typ	Best.-Nr.	Verpack.-Einheit	Artikel-Gruppe	Länge (mm)	Profil (mm)	Bohrung (mm)	Gewinde M	Farbe
L100	90391	1	L	280	50/50	7	M8	■
L185/1	90392	1	L	500	50/50	7	M10	■
L185/2	90395	1	L	500	50/50	7	M10	■



Schienenhalter Z

Halter Z100

Best.-Nr. 90381

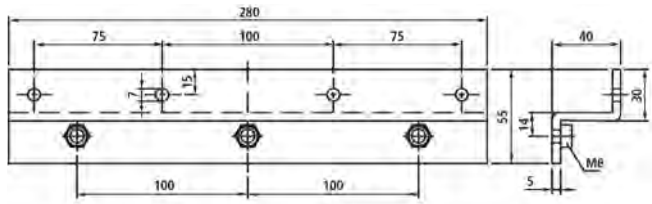

Halter Z185/1

Best.-Nr. 90382

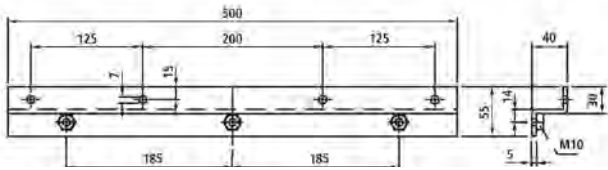

Halter Z185/2 (2 x M10 je Phase)

Best.-Nr. 90385

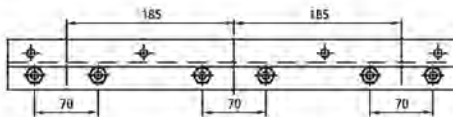

Schienenhalter allgemein

Eigenschaften des Rohmaterials (GFK-Profil, heißgehärtet)

- Temperaturbereich -40 °C bis +130 °C
- Betriebs-Wechselspannung 1000 Volt
- Dauerstrom
 - L/Z 280 mm 2500 A
 - L/Z 500 mm 4000 A
- Phasenabstand
 - L/Z 280 mm 100 mm
 - L/Z 500 mm 185 mm
- Formbeständigkeit DIN 53462 °C > 200
- Rohdichte DIN 53479 gr/cm² ca. 1,7
- Brandverhalten UL 94 HB
- Durchschlagfestigkeit DIN 53481 kV/cm 10
- Kriechstromfestigkeit DIN IEC 112 CTI 600
- Spezifischer Durchgangswiderstand DIN 53482 Ohm x cm 1012

Alle Schienen typgeprüft nach VDE 0660 Teil 500

- Anziehdrehmoment für M10 ca. 4,5 Nm
- Cu-Schiene 10 mm stark aus Kupfer F30 unvernickelt

Typgeprüft gemäß IEC 61439-2: 2011-08, EN 61439-2: 2012-06 mit praxisnahen Sicherungsabständen und Stützweiten.

Typ	Best.-Nr.	Verpack.-Einheit	Artikel-Gruppe	Länge (mm)	Profil (mm)	Bohrung (mm)	Gewinde M	Farbe
Z100	90381	1	Z	280	30/40/30	7	M8	■
Z185/1	90382	1	Z	500	30/40/30	7	M10	■
Z185/2	90385	1	Z	500	30/40/30	7	M10	■

Kurzschlussfestigkeit der vertikalen Schienenhalter L 100 und Z 185-2

Schienenhalter Typ	Aufbau gemäß Abbildung	CU-Schienen je Phase	Phasen-Mitten-Abstand (mm)	Stützweite (mm)	Nennstoßstrom I _{pk} (kA)	Kurzzeitstromfestigkeit (kA/1 sek)
L 100 / 1x M8	Art.-Nr. 90391	1 x 30 mm x 10 mm	100	300	105	50
Z185-2 / 2xM10	Art.-Nr. 90382	1 x 100 mm x 10 mm	185	400	176	80





Weitere Produkte

Nebenwiderstände

Amperemeter-Umschalter

Voltmeter-Umschalter

NEOZED-Sicherungssockel

Kontaktflasche





Nebenwiderstand

Technische Daten

Einsatzbedingungen

Arbeitstemperaturbereich:	$-10 \leq \vartheta \leq +55 \text{ °C}$
Lagertemperaturbereich:	$-25 \leq \vartheta \leq +65 \text{ °C}$
Relative Luftfeuchte (keine Betauung):	$\leq 75 \%$
Klimaeignung:	Klimaklasse 3 nach VDE/VDI 3540

Genauigkeit

Genauigkeitsklasse	Klasse 0,5 (Klasse 0,2 auf Anfrage)
--------------------	--

Material

Widerstandsstäbe:	Manganin
Anschlussstücke:	
Bauform A	Messing
Bauform B/C	Kupfer

Anschlüsse

Strompfad:	siehe Maßbilder
Spannungspfad:	M 5 x 8

Abmessungen

siehe Maßbilder

Schutzart

IP 00

Materialprofil der Anschlussstücke

Bauform A	mit Isoliersockel (...25 A) ohne Isoliersockel (30...150 A)
Bauform B	L-Profile
Bauform C	T-Profile

Gewicht

auf Anfrage

Anwendung

Nebenwiderstände (Shunts) werden zur indirekten Erfassung von elektrischen Strömen hoher Stromstärken verwendet. Die Fertigung der Shunts erfolgt in Übereinstimmung mit den Forderungen der DIN 43703 für Stromstärken von 1 A bis 20 000 A und Spannungsabfälle von 60 mV bis 300 mV. Auf Wunsch sind auch weitere, von der DIN-Reihe abweichende Nenngrößen von Strom und Spannungsabfall, lieferbar.

Funktionsprinzip

Der den Nebenwiderstand durchfließende Strom erzeugt einen Spannungsabfall, welcher mit einem parallel geschalteten Messgerät gemessen werden kann. Durch die Parallelschaltung von Nebenwiderstand und Messgerät ist somit die Verwendung von Spannungsmessgeräten zur Strommessung bzw. eine Messbereichserweiterung vorhandener Strommessgeräte möglich. In Abhängigkeit vom Nennstrom werden die Nebenwiderstände in 3 verschiedenen Bauformen gefertigt.

Fertigungsvorschriften

DIN 43703	Nebenwiderstände
DIN 43780	Direktwirkende, anzeigende Messgeräte und ihr Zubehör

Sonderausführungen

Nennspannungsabfall	nach Kundenvorgabe
Nennstrom	nach Kundenvorgabe
Genauigkeitsklasse	0,2
Isoliersockel	für Nebenwiderstände 30...200 A/60 mV

Bestellangaben	
Typ	Nebenwiderstand
Nennspannungsabfall	60 mV 100 mV 150 mV 300 mV nach Angabe**)
Nennstrom	siehe Tabelle im Datenteil nach Angabe**)
Genauigkeit	Klasse 0,5*) Klasse 0,2 auf Anfrage
Isoliersockel	für Bauform A sind mit Schnappbefestigungen für Normschienen lieferbar 1...25 A Standard 30...200 A (60 mV) Zubehör
Abdeckkappe	1...25 A (60 mV; 100 mV; 150 mV) Zubehör 30...200 A (60 mV) Zubehör
nach Wunsch**)	auf Anfrage

*) Standard **) hierfür genaue Daten per Klartext angeben

Bestellbeispiel:

Nebenwiderstand, Nennspannungsabfall 60 mV, Nennstrom 1000 A, Klasse 0,5

Technische Änderungen vorbehalten



Nebenwiderstände

Bauform A

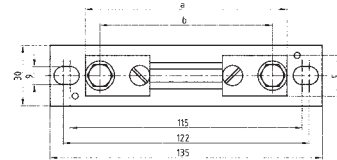
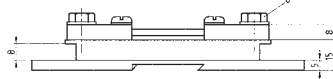

Material Widerstandsstäbe
Material Anschlussstücke
Anschlüsse Spannungspfad
Klasse

Manganin
Messing
M 5 x 8
0,5

Best.-Nr.	Nennstrom	Nennspannungsabfall	Socket	Maß a	Maß b	Maß c	Maß d	Maß g
71911S	1	60	Ja	90	78	20	8	M 5 x 12
71912S	1,5	60	Ja	90	78	20	8	M 5 x 12
71913S	2,5	60	Ja	90	78	20	8	M 5 x 12
71914S	4	60	Ja	90	78	20	8	M 5 x 12
71915S	6	60	Ja	90	78	20	8	M 5 x 12
71916S	10	60	Ja	90	78	20	8	M 5 x 12
71917S	15	60	Ja	90	78	20	8	M 5 x 12
71918S	25	60	Ja	90	78	20	8	M 5 x 12
71919	40	60	Nein	100	80	20	8	M 8 x 16
71919S	40	60	Ja	100	80	20	8	M 8 x 16
71920	60	60	Nein	100	80	20	8	M 8 x 16
71920S	60	60	Ja	100	80	20	8	M 8 x 16
71921	100	60	Nein	100	80	20	8	M 8 x 16
71921S	100	60	Ja	100	80	20	8	M 8 x 16
71922	150	60	Nein	100	80	20	8	M 8 x 16
71922S	150	60	Ja	100	80	20	8	M 8 x 16
72911S	1	100	Ja	90	78	20	8	M 5 x 12
72912S	1,5	100	Ja	90	78	20	8	M 5 x 12
72913S	2,5	100	Ja	90	78	20	8	M 5 x 12
72914S	4	100	Ja	90	78	20	8	M 5 x 12
72915S	6	100	Ja	90	78	20	8	M 5 x 12
72916S	10	100	Ja	90	78	20	8	M 5 x 12
72917S	15	100	Ja	90	78	20	8	M 5 x 12
72918S	25	100	Ja	90	78	20	8	M 5 x 12
72919	40	100	Nein	145	125	25	8	M 8 x 16
72919S	40	100	Ja	145	125	25	8	M 8 x 16
72920	60	100	Nein	145	125	25	8	M 8 x 16
72920S	60	100	Ja	145	125	25	8	M 8 x 16
72921	100	100	Nein	145	125	25	8	M 8 x 16
72921S	100	100	Ja	145	125	25	8	M 8 x 16
72922	150	100	Nein	145	125	25	8	M 8 x 16
72922S	150	100	Ja	145	125	25	8	M 8 x 16
73911S	1	150	Ja	90	78	20	8	M 5 x 12
73912S	1,5	150	Ja	90	78	20	8	M 5 x 12
73913S	2,5	150	Ja	90	78	20	8	M 5 x 12
73914S	4	150	Ja	90	78	20	8	M 5 x 12
73915S	6	150	Ja	90	78	20	8	M 5 x 12
73916S	10	150	Ja	90	78	20	8	M 5 x 12
73917S	15	150	Ja	90	78	20	8	M 5 x 12



MBS AG



Best.-Nr.	Nennstrom	Nennspannungsabfall	Socket	Maß a	Maß b	Maß c	Maß d	Maß g
73918S	25	150	Ja	90	78	20	8	M 5 x 12
73919	40	150	Nein	225	205	25	8	M 8 x 16
73919S	40	150	Ja	225	205	25	8	M 8 x 16
73920	60	150	Nein	225	205	25	8	M 8 x 16
73920S	60	150	Ja	225	205	25	8	M 8 x 16
73921	100	150	Nein	225	205	25	8	M 8 x 16
73921S	100	150	Ja	225	205	25	8	M 8 x 16
73922	150	150	Nein	225	205	25	8	M 8 x 16
73922S	150	150	Ja	225	205	25	8	M 8 x 16
74911S	1	300	Ja	90	78	20	8	M 5 x 12
74912S	1,5	300	Ja	90	78	20	8	M 5 x 12
74913S	2,5	300	Ja	90	78	20	8	M 5 x 12
74914S	4	300	Ja	90	78	20	8	M 5 x 12
74915S	6	300	Ja	90	78	20	8	M 5 x 12
74916S	10	300	Ja	90	78	20	8	M 5 x 12
74917S	15	300	Ja	90	78	20	8	M 5 x 12
74918S	25	300	Ja	90	78	20	8	M 5 x 12
74919	40	300	Nein	384	364	25	8	M 8 x 16
74919S	40	300	Ja	384	364	25	8	M 8 x 16
74920	60	300	Nein	384	364	25	8	M 8 x 16
74920S	60	300	Ja	384	364	25	8	M 8 x 16
74921	100	300	Nein	384	364	25	8	M 8 x 16
74921S	100	300	Ja	384	364	25	8	M 8 x 16
74922	150	300	Nein	384	364	25	8	M 8 x 16
74922S	150	300	Ja	384	364	25	8	M 8 x 16

Nebenwiderstände

Amperemeter-Umschalter

Voltmeter-Umschalter

NEOZED-Sicherungssockel

Kontaktflasche



Nebenwiderstände

Bauform B

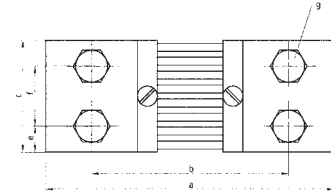
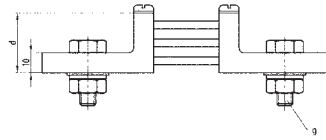
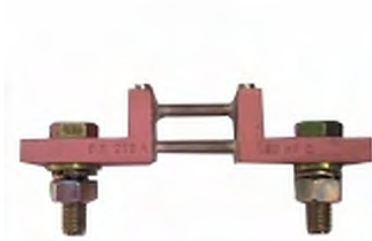

Material Widerstandsstäbe
Material Anschlussstücke
Anschlüsse Spannungspfad
Klasse

Manganin
Kupfer
M 5 x 8
0,5

Best.-Nr.	Nennstrom	Nennspannungsabfall	Sockel	Maß a	Maß b	Maß c	Maß d	Maß e	Maß f	Maß g	Zahl der Stromanschlüsse
71923	250	60	Nein	145	105	30	30	15		M 12 x 40	2 x 1
71924	400	60	Nein	145	105	40	30	20		M 16 x 45	2 x 1
71925	600	60	Nein	145	105	40	30	20		M 16 x 45	2 x 1
71926	1000	60	Nein	165	115	60	30	30		M 20 x 50	2 x 1
71927	1500	60	Nein	165	115	90	30	21	48	M 16 x 45	2 x 2
71996	1500	60	Nein	165	115	90	30	21	48	M 16 x 45	2 x 2
71997	2500	60	Nein	165	115	120	30	30	60	M 20 x 50	2 x 2
72923	250	100	Nein	190	150	30	30	15		M 12 x 40	2 x 1
72924	400	100	Nein	190	150	40	30	20		M 16 x 45	2 x 1
72925	600	100	Nein	190	150	40	30	20		M 16 x 45	2 x 1
72926	1000	100	Nein	210	160	60	30	30		M 20 x 50	2 x 1
72935	1500	100	Nein	210	160	120	30	30	60	M 20 x 50	2 x 2
73923	250	150	Nein	270	230	30	50	15		M 12 x 40	2 x 1
73924	400	150	Nein	270	230	40	50	20		M 16 x 45	2 x 1
73925	600	150	Nein	270	230	40	50	20		M 16 x 45	2 x 1
73926	1000	150	Nein	290	240	70	60	35		M 20 x 50	2 x 1
74923	250	300	Nein	429	389	30	50	15		M 12 x 40	2 x 1
74924	400	300	Nein	429	389	40	50	20		M 16 x 45	2 x 1
74925	600	300	Nein	429	389	40	50	20		M 16 x 45	2 x 1
74926	1000	300	Nein	449	399	70	60	35		M 20 x 50	2 x 1



Nebenwiderstände

Bauform C

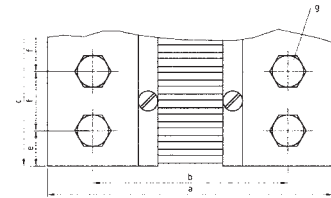
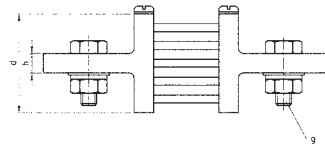

Material Widerstandsstäbe
Material Anschlussstücke
Anschlüsse Spannungspfad
Klasse

Manganin
Kupfer
M 5 x 8
0,5

Best.-Nr.	Nennstrom	Nennspannungsabfall	Sockel	Maß a	Maß b	Maß c	Maß d	Maß e	Maß f	Maß g	Maß h	Zahl der Stromanschlüsse
71929	4000	60	Nein	165	1150	120	60	30	60	M 20 x 60	15	2 x 2
71930	6000	60	Nein	175	125	154	130	25	52	M 20 x 75	25	2 x 3
71931	10000	60	Nein	185	135	206	170	25	52	M 20 x 80	30	2 x 4
71932	15000	60	Nein	185	135	310	170	25	52	M 20 x 80	30	2 x 6
72928	2500	100	Nein	210	160	120	60	30	60	M 20 x 50	15	2 x 2
72929	4000	100	Nein	220	170	120	130	30	60	M 20 x 50	25	2 x 2
72930	6000	100	Nein	220	170	154	130	25	52	M 20 x 75	25	2 x 3
73927	1500	150	Nein	290	240	90	60	21	48	M 16 x 60	15	2 x 1
73928	2500	150	Nein	290	240	120	60	30	60	M 20 x 60	15	2 x 1
73929	4000	150	Nein	300	250	120	130	30	60	M 20 x 75	25	2 x 2
73930	6000	150	Nein	300	250	154	130	25	52	M 20 x 75	25	2 x 3
73931	10000	150	Nein	310	260	206	170	25	52	M 20 x 80	30	2 x 4
74927	1500	300	Nein	449	399	90	60	21	48	M 16 x 60	15	2 x 1
74928	2500	300	Nein	449	399	120	60	30	60	M 20 x 60	15	2 x 2
74929	4000	300	Nein	459	409	120	130	30	60	M 20 x 75	25	2 x 2
74930	6000	300	Nein	459	409	154	130	25	52	M 20 x 75	25	2 x 3



Weitere Produkte

Amperemeter-Umschalter



Amperemeter-Umschalter		Best.-Nr.
Amperemeter-Umschalter	mit 0-Stellung	59061
Amperemeter-Umschalter	ohne 0-Stellung	59062

Voltmeter-Umschalter



Voltmeter-Umschalter		Best.-Nr.
Voltmeter-Umschalter	mit 0-Stellung	59060
Voltmeter-Umschalter	ohne 0-Stellung	59063

NEOZED-Sicherungssockel

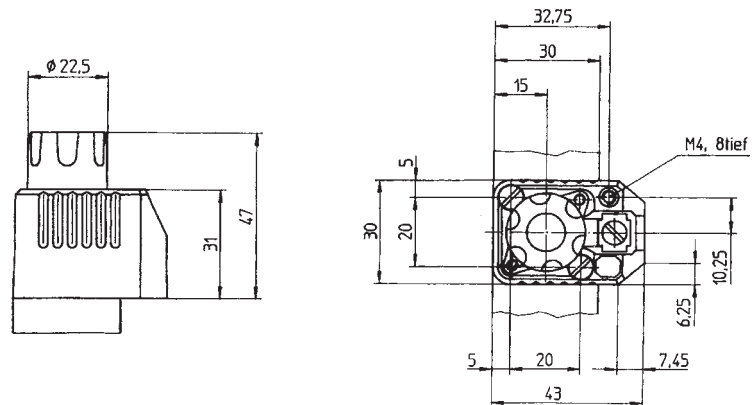

NEOZED-Sicherungssockel		Best.-Nr.
Sicherungssockel 10 A		59011

Kontaktlasche

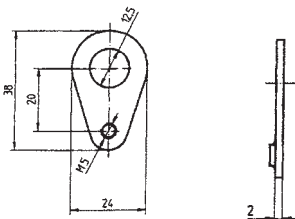

Kontaktlasche	Länge	Dicke	Breite	Best.-Nr.
Gewinde M5	38	2	24	59055





MBS AG





Spannungswandler

MBEV
MBER
MBE

Einpolig isoliert

MBZV
MBZR
MBZ

Zweipolig isoliert



Spannungswandler

Einpolig isoliert



Bemessungsspannung	Sekundäre Bemessungsspannung 100 V/ $\sqrt{3}$ V				
Typ	MBEV 6	MBEV 10	MBEV 20	MBEV 50	MBEV 100
Genauigkeitsklasse	1	0,5/1	0,5/1	0,5/1	0,5/1
Bemessungs-Scheinleistung	VA 3	VA 5/10	VA 10/20	VA 25/50	VA 50/100
Primär V	Best.-Nr.	Best.-Nr.	Best.-Nr.	Best.-Nr.	Best.-Nr.
100/ $\sqrt{3}$	SEV1001	SEV1010	SEV1019	SEV1028	SEV1037
110/ $\sqrt{3}$	SEV1002	SEV1011	SEV1020	SEV1029	SEV1038
220/ $\sqrt{3}$	SEV1003	SEV1012	SEV1021	SEV1030	SEV1039
380/ $\sqrt{3}$	SEV1004	SEV1013	SEV1022	SEV1031	SEV1040
400/ $\sqrt{3}$	SEV1005	SEV1014	SEV1023	SEV1032	SEV1041
500/ $\sqrt{3}$	SEV1006	SEV1015	SEV1024	SEV1033	SEV1042
600/ $\sqrt{3}$	SEV1007	SEV1016	SEV1025	SEV1034	SEV1043
800/ $\sqrt{3}$			SEV1026	SEV1035	SEV1044
1000/ $\sqrt{3}$			SEV1027	SEV1036	SEV1045

Zweipolig isoliert

Bemessungsspannung	Sekundäre Bemessungsspannung 100 V				
Typ	MBZV 6	MBZV 10	MBZV 20	MBZV 50	MBZV 100
Genauigkeitsklasse	1	0,5/1	0,5/1	0,5/1	0,5/1
Bemessungs-Scheinleistung	VA 6	VA 10/20	VA 20/40	VA 50/100	VA100/200
Primär V	Best.-Nr.	Best.-Nr.	Best.-Nr.	Best.-Nr.	Best.-Nr.
100	SZV1001	SZV1010	SZV1019	SZV1028	SZV1037
110	SZV1002	SZV1011	SZV1020	SZV1029	SZV1038
220	SZV1003	SZV1012	SZV1021	SZV1030	SZV1039
380	SZV1004	SZV1013	SZV1022	SZV1031	SZV1040
400	SZV1005	SZV1014	SZV1023	SZV1032	SZV1041
500	SZV1006	SZV1015	SZV1024	SZV1033	SZV1042
600	SZV1007	SZV1016	SZV1025	SZV1034	SZV1043
800			SZV1026	SZV1035	SZV1044
1000			SZV1027	SZV1036	SZV1045

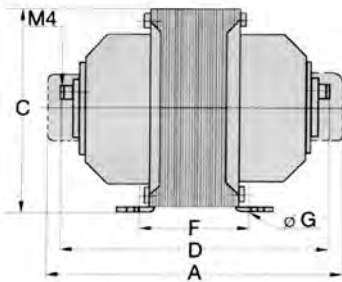
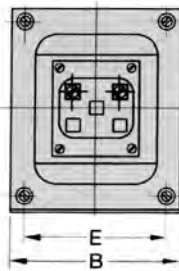

Technische Daten der Normalausführung

Standard	IEC 61869/1+3	
Höchste Spannung für Betriebsmittel	0,72 kV bis 600 V – 1,2 kV bis 1000 V	
Prüfspannung	0,72 kV/3 kV; 1 kV/6 kV	
Nennfrequenz	50/60 Hz	
Einsatzort	Innenraum bis 2000 m über NN	
Klimatische Bedingung	IEC 60721-3-3	3K4
Mechanische Bedingung	IEC 60721-3-3	3M3
Rüttelfestigkeit	IEC 60068-2	2.5 g (25...100 Hz)
Isolierstoffklasse	IEC 60085	E (120 °C)
Gehäuseschutzart	IEC 60529	Gehäuse: IP 50 Klemmen mit Abdeckung: IP 20
Isoliermaterial	UL E44423 UL E47960 UL E93687 UL E51047	Kupferlackdraht Wicklungskontakte Isolationsschicht Imprägnierlack

Typ	Gehäuse in mm							Gewicht kg	Standardzubehör
	A	B	C	D	E	F	Ø G		
MBEV 6	140	85	100	125	68	52	4,5	2,3	Klemmenabdeckung
MBEV 10	165	90	105	145	70	67	4,5	3	
MBEV 20	175	90	105	155	70	82	4,5	4,1	
MBEV 50	195	105	125	175	81	95	5,5	6	
MBEV 100	210	128	155	190	101	97	8	8	
MBZV 6	140	85	100	125	68	52	4,5	2,3	Klemmenabdeckung
MBZV 10	165	90	105	145	70	67	4,5	3	
MBZV 20	175	90	105	155	70	82	4,5	4,1	
MBZV 50	195	105	125	175	81	95	5,5	6	
MBZV 100	210	128	155	190	101	97	8	8	



Spannungswandler

Einpolig isoliert

Bemessungsspannung	Primär V	Typ	Größe	Sekundäre Bemessungsspannung 100 V/√3								
				Genauigkeitsklasse								
				0,2		0,5		1		3		P ₁
VA	Best.-Nr.	VA	Best.-Nr.	VA	Best.-Nr.	VA	Best.-Nr.	VA	A			
100 V/√3 110 V/√3 200 V/√3 220 V/√3 230 V/√3 Isolationsniveau entsprechend U _m = 0,72 kV	MBER 60	2	–	–	–	–	0,5	SE1001	1,5	SE1002	0,3	0,6
	MBER 70		0,2	SE1003	0,5	SE1004	1	SE1005	3	SE1006	0,6	0,8
	MBER 100		1	SE1007	2,5	SE1008	5	SE1009	15	SE1010	1,5	1,2
	MBER 104		5	SE1011	15	SE1012	30	SE1013	30	SE1014	2	0,9
	MBE 100		–	–	10	SE1015	15	SE1016	50	SE1017	5	1
	MBE 150	1	7,5	SE1018	20	SE1019	50	SE1020	120	SE1021	10	3
	MBE 150	2	10	SE1022	30	SE1023	60	SE1024	150	SE1025	12	3
	MBE 150	3	15	SE1026	50	SE1027	100	SE1028	200	SE1029	15	3
	MBE 150	4	25	SE1030	60	SE1031	120	SE1032	250	SE1033	20	3
380 V/√3; 400 V/√3 500 V/√3; 600 V/√3 660 V/√3 Isolationsniveau entsprechend U _m = 0,72 kV	MBER 100		0,5	SE1034	1,5	SE1035	3	SE1036	10	SE1037	1,5	1,2
	MBER 104		5	SE1038	10	SE1039	25	SE1040	25	SE1041	2	0,9
	MBE 100		–	–	10	SE1042	15	SE1043	50	SE1044	5	1
	MBE 150	1	7,5	SE1045	20	SE1046	50	SE1047	120	SE1048	10	3
	MBE 150	2	10	SE1049	30	SE1050	60	SE1051	150	SE1052	12	3
	MBE 150	3	15	SE1053	50	SE1054	100	SE1055	200	SE1056	15	3
	MBE 150	4	25	SE1057	60	SE1058	120	SE1059	250	SE1060	20	3
	MBE 150											
690 V/√3 750 V/√3 1000 V/√3 Isolationsniveau entsprechend U _m = 1,2 kV	MBER 100/1		–	–	1	SE1061	2	SE1062	5	SE1063	1,5	1,2
	MBER 104/1		5	SE1064	10	SE1065	25	SE1066	25	SE1067	2	0,9
	MBE 100/1		–	–	7,5	SE1068	15	SE1069	30	SE1070	5	1
	MBE 150/1	1	7,5	SE1071	20	SE1072	45	SE1073	100	SE1074	10	3
	MBE 150/1	2	10	SE1075	30	SE1076	60	SE1077	120	SE1078	12	3
	MBE 150/1	3	15	SE1079	45	SE1080	90	SE1081	150	SE1082	15	3
	MBE 150/1	4	20	SE1083	60	SE1084	100	SE1085	180	SE1086	20	3

Mehrpreise für Sonderausführung

Zusatzwicklung zur Bildung einer offenen Dreieckswicklung (Leistung der Messwicklung um ca. 30% verringert): .../√3/.../√3/100/√3 V

Typ	Größe	Nennlangzeitstrom
MBE 150	–	1 A / 8 h

Typ	Größe	Nennlangzeitstrom
MBE 100	–	1 A / 8 h
MBE 150	1	5 A / 8 h
MBE 150	2	6 A / 8 h
MBE 150	3	8 A / 8 h

Zwischen-Spannungswandler zur Bildung einer offenen Dreieckswicklung (ohne Messwicklung): 100/√3/100/√3 V

Typ	Tropenfest	Gießharzausguss
MBE (Z) R 60		
MBE (Z) R 70		
MBE (Z) R 100 (/1)		
MBE (Z) R 104 (/1)		
MBE (Z) 100 (/1)		–
MBE (Z) 150 (/1)		–

Schnappbefestigung für:

gemeinsame Fußbefestigung für:

Typ
MBE (Z) R 60
MBE (Z) R 70

Typ
MBE (Z) R 70

Weitere Sonderausführungen auf Anfrage



Spannungswandler

Zweipolig isoliert

Bemessungsspannung	Primär V		Sekundäre Bemessungsspannung 100 V								P _i	L _{2th}
			Genauigkeitsklasse									
			0,2		0,5		1		3			
Typ	Größe	VA	Best.-Nr.	VA	Best.-Nr.	VA	Best.-Nr.	VA	Best.-Nr.	VA	A	
100, 110, 200, 220, 230 Isolationsniveau entsprechend U _m = 0,72 kV	MBZR 60	2	–	–	0,5	SZ1001	1	SZ1002	3	SZ1003	0,5	0,4
	MBZR 70		1	SZ1004	2,5	SZ1005	5	SZ1006	15	SZ1007	2	0,5
	MBZR 100		2	SZ1008	5	SZ1009	10	SZ1010	25	SZ1011	2,5	0,8
	MBZR 104		5	SZ1012	15	SZ1013	30	SZ1014	30	SZ1015	3	0,9
	MBZ 100		–	–	15	SZ1016	30	SZ1017	60	SZ1018	9	1
	MBZ 150	1	10	SZ1019	25	SZ1020	60	SZ1021	150	SZ1022	12	3
	MBZ 150	2	15	SZ1023	45	SZ1024	90	SZ1025	200	SZ1026	15	3
	MBZ 150	3	20	SZ1027	60	SZ1028	120	SZ1029	250	SZ1030	18	3
	MBZ 150	4	30	SZ1031	75	SZ1032	150	SZ1033	300	SZ1034	24	3
380, 400, 500, 600, 660 Isolationsniveau entsprechend U _m = 0,72 kV	MBZR 60	2	–	–	*	*	1	SZ1035	3	SZ1036	0,5	0,4
	MBZR 70		0,5	SZ1037	1,25	SZ1038	2,5	SZ1039	7,5	SZ1040	1,5	0,5
	MBZR 100		1,5	SZ1041	3	SZ1042	10	SZ1043	20	SZ1044	2	0,8
	MBZR 104		5	SZ1045	10	SZ1046	25	SZ1047	25	SZ1048	2,5	0,9
	MBZ 100		–	–	15	SZ1049	30	SZ1050	60	SZ1051	9	1
	MBZ 150	1	10	SZ1052	25	SZ1053	60	SZ1054	150	SZ1055	12	3
	MBZ 150	2	15	SZ1056	45	SZ1057	90	SZ1058	200	SZ1059	15	3
	MBZ 150	3	20	SZ1060	60	SZ1061	120	SZ1062	250	SZ1063	18	3
	MBZ 150	4	30	SZ1064	75	SZ1065	150	SZ1066	300	SZ1067	24	3
690, 750, 1000 Isolationsniveau entsprechend U _m = 1,2 kV	MBZR 60/1	2	–	–	*	*	*	*	*	*	0,5	0,4
	MBZR 70/1		*	*	*	*	*	*	*	*	1,5	0,5
	MBZR 100/1		1	SZ1068	2,5	SZ1069	5	SZ1070	15	SZ1071	1,5	0,8
	MBZR 104/1		5	SZ1072	10	SZ1073	25	SZ1074	25	SZ1075	2,5	0,9
	MBZ 100/1		–	–	7,5	SZ1076	15	SZ1077	30	SZ1078	9	0,8
	MBZ 150/1	1	7,5	SZ1079	20	SZ1080	50	SZ1081	120	SZ1082	12	2
	MBZ 150/1	2	10	SZ1083	30	SZ1084	60	SZ1085	150	SZ1086	15	2
	MBZ 150/1	3	15	SZ1087	45	SZ1088	100	SZ1089	200	SZ1090	18	2
	MBZ 150/1	4	20	SZ1091	60	SZ1092	120	SZ1093	250	SZ1094	24	2

* auf Anfrage

Technische Daten der Normalausführung			
Standard	IEC 61869/1+3		
Höchste Spannung für Betriebsmittel	U _m 0,72 kV (U _m 1,2 kV)	MBE.... MBZ...	
Prüfspannung	3 kV, 50 Hz, 1 min (6 kV, 50 Hz, 1 min)		
Nennfrequenz	50...60 Hz		
Einsatzort	Innenraum bis 2000 m über NN		
Klimatische Bedingung	IEC 721	3K4	
Mechanische Bedingung	IEC 721	3K3	
Rüttelfestigkeit	IEC 68-2	2,5 g (25...100 Hz)	
Isolierstoffklasse	DIN IEC 85 VDE 0301-1	E 120 °C	
Gehäuseschutzart	IEC EN 60529 DIN VDE 0470	Gehäuse: IP 50 Klemmen mit Abdeckung: IP 20	



Spannungswandler

Typ	Größe	Gehäuse in mm				Gewicht kg	Standardzubehör
		Breite	Höhe	Tiefe	h		
MBZR 60 (/1)	2	60	78	52		0,5	Fußbefestigung Klemmenabdeckung
MBZR 70 (/1)		70	86	52		0,6	
MBZR 100 (/1)		100	118	73		1,1	
MBZR 104 (/1)		104	127	75		2,0	
MBZ 100 (/1)		102	105	111		3,1	
MBZ 150 (/1)	1	150	123	142	40	7,0	
MBZ 150 (/1)	2	150	123	152	50	8,0	
MBZ 150 (/1)	3	150	123	162	60	9,0	
MBZ 150 (/1)	4	150	123	182	80	11,5	

MBZR 60 (/1)
(MBER 60)

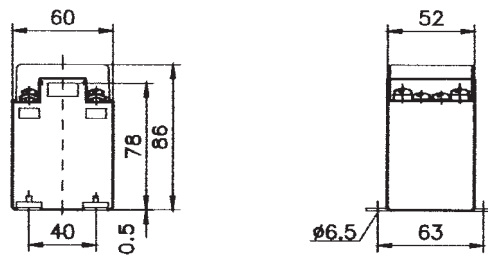

MBZR 70 (/1)
(MBER 70)

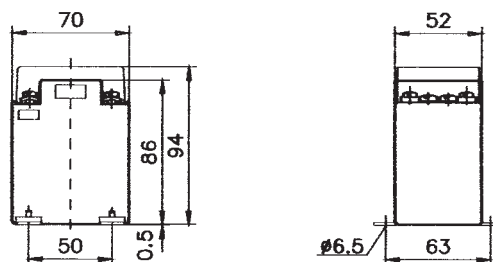

MBZR 100 (/1)
(MBER 100)

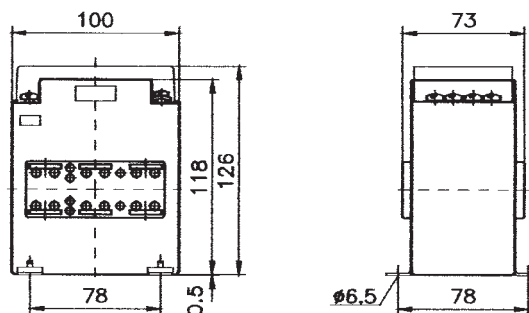

MBZR 104 (/1)
[MBER 104 (/1)]

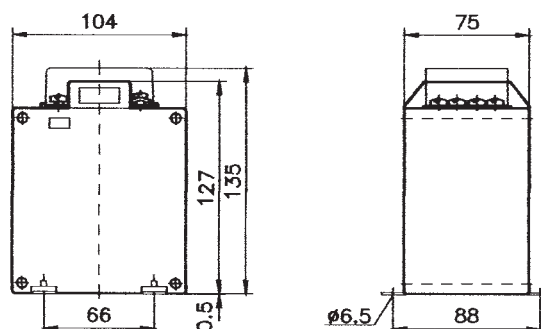

Bestellbeispiel

Typ MBZR 60
 Bemessungsübersetzung 200/100 V
 Bemessungsbürde 0,5 VA
 Genauigkeitsklasse 0,5
 Best.-Nr. SZ1001-200



Spannungswandler

Typ	Größe	Gehäuse in mm				Gewicht kg	Standardzubehör
		Breite	Höhe	Tiefe	h		
MBER 60 (/1)	2	60	78	52		0,5	Fußbefestigung Klemmenabdeckung
MBER 70 (/1)		70	86	52		0,6	
MBER 100 (/1)		100	118	73		1,1	
MBER 104 (/1)		104	127	75		2,0	
MBE 100 (/1)		102	105	111		3,1	
MBE 150 (/1)	1	150	123	142	40	7,0	
MBE 150 (/1)	2	150	123	152	50	8,0	
MBE 150 (/1)	3	150	123	162	60	9,0	
MBE 150 (/1)	4	150	123	182	80	11,5	

MBE 100 (/1)
[MBZ 100 (/1)]

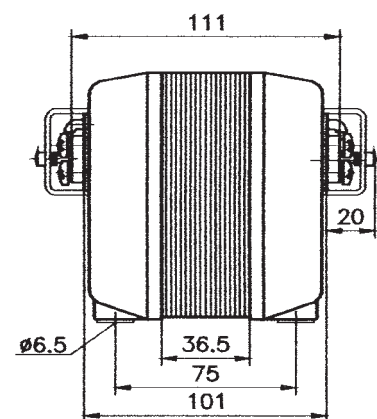
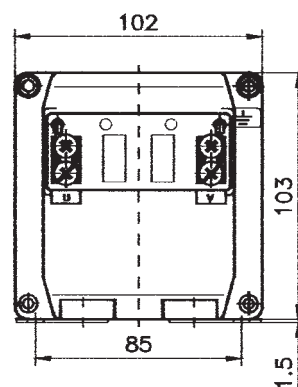

MBE 150 (/1)
[MBZ 150 (/1)]

Größe 1 – Größe 4

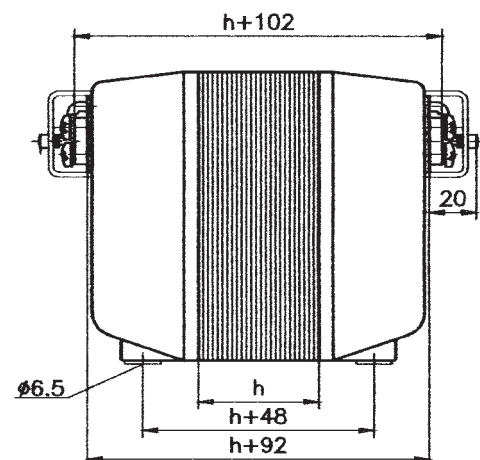
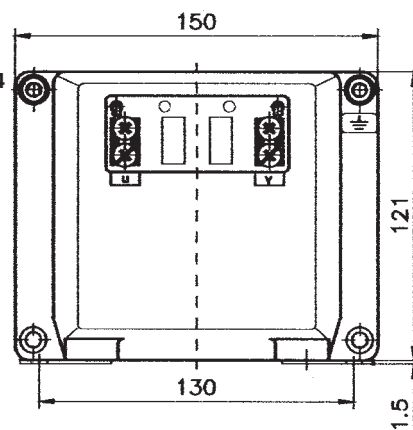

Bestellbeispiel

Typ MBE 100/1
 Bemessungsübersetzung $750/\sqrt{3}/100/\sqrt{3}$
 Bemessungsbürde 15 VA
 Genauigkeitsklasse 1
 Best.-Nr. SE1069-750





MBS AG





CCT Allstromsensor (Messumformer) für Gleich- und Wechselstrom

CCT 31.3 RMS	Primärleiter		30 x 10 mm
	Rundleiter		2 x 20 x 10 mm
	Wandlerbreite		Ø 28 mm 70 mm
CCT 31.3 I	Primärleiter		30 x 10 mm
	Rundleiter		2 x 20 x 10 mm
	Wandlerbreite		Ø 28 mm 70 mm
CCT 31.3 U	Primärleiter		30 x 10 mm
	Rundleiter		2 x 20 x 10 mm
	Wandlerbreite		Ø 28 mm 70 mm

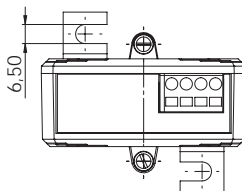
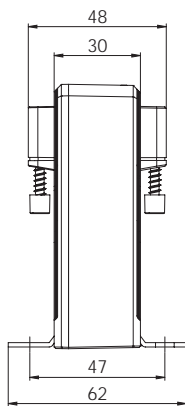
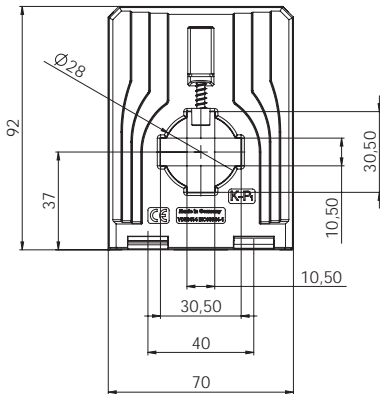

CCT 31.3 RMS

Allstromsensor (Messumformer) für Gleich- und Wechselstrom

Merkmale / Nutzen

- Messung von sowohl Gleich- als auch Wechselströmen mit nur einem Messwandler möglich
- Genaue Berechnung der Echteffektivwerte nahezu beliebiger Zeitverläufe des zu messenden Stromes
- Großer Arbeitsfrequenzbereich von 0 Hz (DC) bzw. 20 Hz ... 6 kHz (AC)
- Hohe elektrische Sicherheit durch galvanisch getrennte Erfassung der Messgröße
- Geringer Leistungsbedarf (< 2,5 VA)
- Einfache und sichere elektrische Verdrahtung mittels Federzugklemmtechnik
- Direkte Montage auf Stromschienen durch am Gerät integrierte Befestigungsschrauben
- Montage auf 35 mm-DIN-Hutschienen mittels optional lieferbarer Schnappbefestigung möglich
- Hohe klimatische und mechanische Beständigkeit durch PU-Vollverguss aller elektrischen Komponenten

Anwendung

Das einen stromdurchflossenen Leiter umgebende Magnetfeld wird von einem den Leiter umschließenden Messkern erfasst. Der im Messkern induzierte, zur Stromstärke im Primärleiter direkt proportionale magnetische Fluss wird mittels eines Halbleiterbauelementes erfasst. Eine im Gerät integrierte Regelelektronik wandelt das vom Halbleiter gelieferte Signal in ein, zum Echteffektivwert der Messgröße proportionales, DC-Ausgangsstromsignal um. Die Berechnung der Echteffektivwerte erfolgt unter Anwendung der Delta-Sigma-Methode. Durch die induktive, berührungslose Erfassung der Messgröße wird ein galvanisch getrenntes Ausgangssignal bereitgestellt.

Die elektrische Kontaktierung des Sekundärkreises des Stromwandlers erfolgt über eine 4-polige Federzugklemme Reihe 739-104 der Firma WAGO. Diese Klemme ist für den Anschluss flexibler Litzeleitungen bis 2,5 mm² geeignet. Zur Versorgung der Regelelektronik wird eine DC-Hilfsspannungsversorgung von 24 V DC benötigt. Die externe Hilfsspannungsversorgung ist über eine Feinsicherung 100 mA / 250 V / F abzusichern.

Übertragungsverhalten CCT 31.3RMS

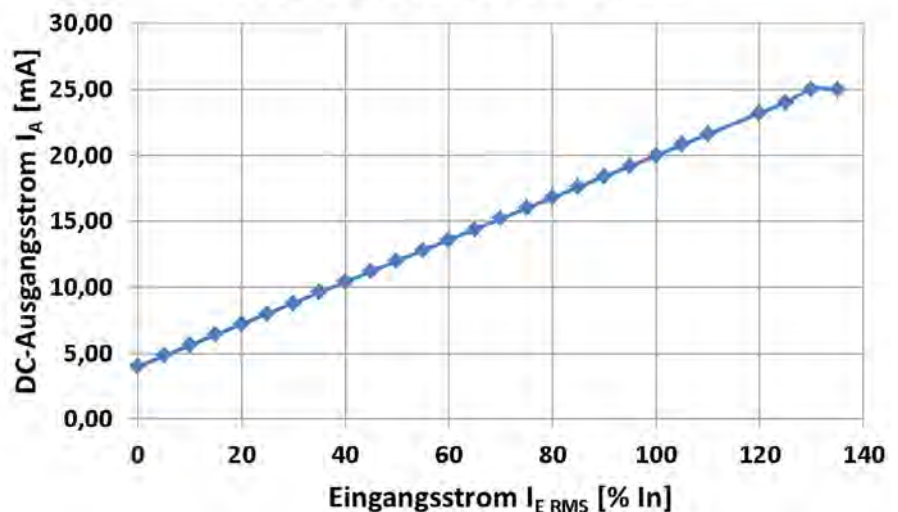



MBS AG



Technische Kennwerte

Elektrische Attribute

Messbereich	0...300 A DC / 0...300 A I _{rms} AC, variantenabhängig! (Nennstrombereiche eingestellt auf Normwerte gem. IEC)
Frequenzbereich	DC, bzw. 20 Hz ... 6 kHz AC, Crest-Faktor ≤ 4
Stromausgang	4...20 mA DC
Max. Bürdenwiderstand am Stromausgang	≤ 500 Ω
Genauigkeit	± 1,0 %
Max. Betriebsspannung U _m	0,72 kV
Isolationsprüfspannung U _{iso}	6,4 kV, U _{eff} , 50 Hz, 5 s, Primärleiter gegen Ausgang / Gehäuse 3 kV, U _{eff} , 50 Hz, 1 min

Hilfsspannung DC	24 V DC ± 15 %, 2,5 VA, unregelt
Sprungantwortzeit (90 % I _{PN} , di/dt = 100 A / μs)	≤ 200 ms (typ. 150 ms)
Signalanstiegs-geschwindigkeit di/dt	< 100 A/μs
Isolierstoffklasse	E
Schutzklasse	IP 20
Max. Temperatur des Primärleiters	100 °C
Arbeitstemperaturbereich	-25 °C ... +60 °C
Lagertemperaturbereich	-40 °C ... +90 °C
Einsatzhöhe	≤ 2000 m

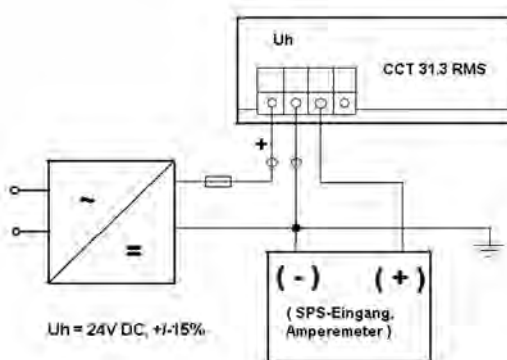

Bestelltabelle

Nennstrom [A]	Ausgangssignal	Best.-Nr.
50	4...20 mA DC	1103-10001
100		1103-10003
150		1103-10005
200		1103-10006
250		1103-10007
300		1103-10008

		Best.-Nr.
	Schnappbefestigung Form A	53011
	Quick-Fix Schnellbefestigung	55021



CCT 31.3 I

Allstromsensor (Messumformer) für Gleich- und Wechselstrom

Merkmale / Nutzen

- Messung von sowohl Gleich- als auch Wechselströmen mit nur einem Messwandler möglich
- Großer Arbeitsfrequenzbereich von 0 Hz (DC) bis 100 kHz (AC)
- Hohe elektrische Sicherheit durch galvanisch getrennte Erfassung der Messgröße
- Einfache und sichere elektrische Verdrahtung mittels Federzugklemmtechnik
- Direkte Montage auf Stromschienen durch am Gerät integrierte Befestigungsschrauben
- Montage auf 35 mm-DIN-Hutschienen mittels optional lieferbarer Schnappbefestigung möglich
- Hohe klimatische und mechanische Beständigkeit durch PU-Vollverguss aller elektrischen Komponenten

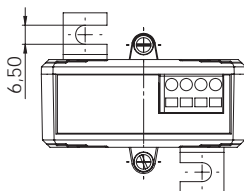
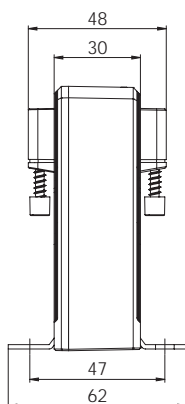
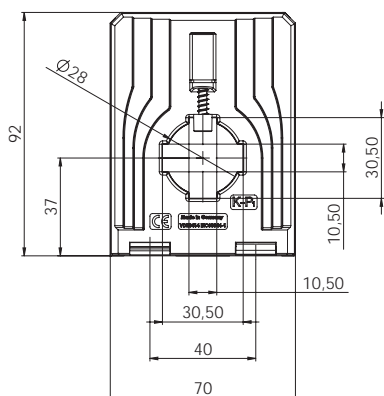

Anwendung

Das einen stromdurchflossenen Leiter umgebende Magnetfeld wird von einem, den Leiter umschließenden, Messkern erfasst. Der im Messkern induzierte, zur Stromstärke im Primärleiter direkt proportionale magnetische Fluss wird mittels eines Halbleiterbauelementes erfasst. Eine im Gerät integrierte Regelelektronik wandelt das vom Halbleiter gelieferte Signal in ein zum zeitlichen Verlauf der Messgröße direkt proportionales Ausgangssignalsignal um.

Durch die induktive, berührungslose Erfassung der Messgröße wird ein galvanisch getrenntes Ausgangssignal bereitgestellt.

Die elektrische Kontaktierung des Sekundärkreises des Stromwandlers erfolgt über eine 4-polige Federzugklemme Reihe 739-104 der Firma WAGO. Diese Klemme ist für den Anschluss flexibler Litzeleitungen bis 2,5 mm² geeignet. Zur Versorgung der Regelelektronik wird eine DC-Hilfsspannungsversorgung von ± 12 V benötigt.

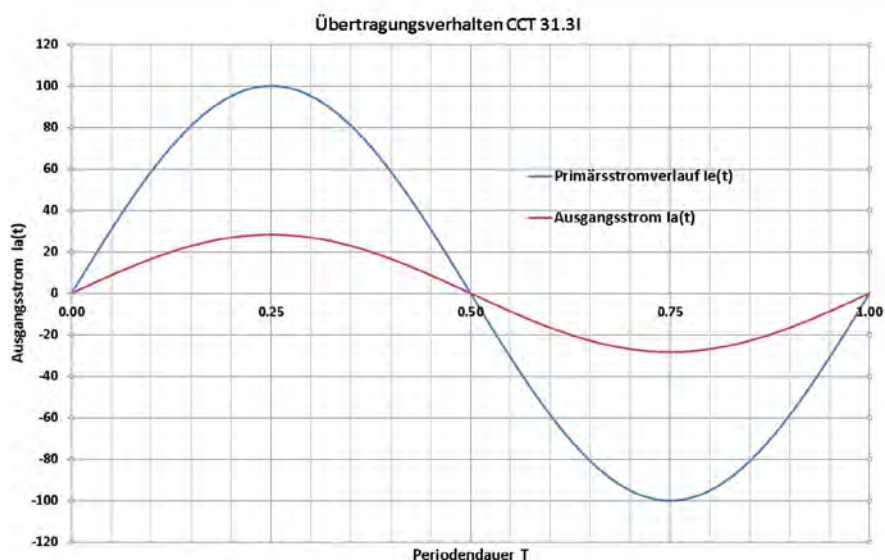



MBS AG



Technische Kennwerte

Elektrische Attribute

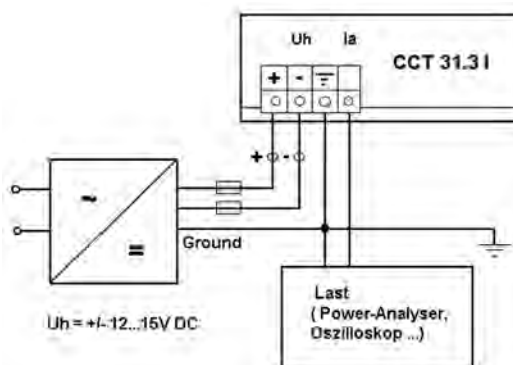

Messbereich	0...300 A DC / AC I_{eff} , varianten-abhängig! (Nennstrombereiche eingestellt auf Normwerte gem. IEC)
Frequenzbereich	0...100 kHz
Stromausgang bei AC-Eingangssignal	AC: 0...20 mA I_{eff} ($\pm 28,2843$ mA I_{Peak})
Stromausgang bei DC-Eingangssignal	DC: 0 ... ± 20 mA
Max. Bürdenwiderstand am Stromausgang	200 Ω
Genauigkeit	0,5 %
Max. Betriebsspannung U_m	0,72 kV

Isolationsprüfspannung U_{iso}	6,4 kV, U_{eff} 50 Hz, 5 s 3 kV, U_{eff} 50 Hz, 1 min
Hilfsspannung DC	$\pm 12 \dots 15$ V DC, unregelt
Sprungantwortzeit (90 % I_{PN} , $di/dt = 100$ A / μ s)	< 1 μ s
Signalanstiegs-geschwindigkeit di/dt	< 100 A/ μ s
Isolierstoffklasse	E
Schutzklasse	IP 20
Max. Temperatur des Primärleiters	100 °C
Arbeitstemperaturbereich	-25 °C ... +60 °C
Lagertemperaturbereich	-40 °C ... +90 °C
Einsatzhöhe	≤ 2000 m



Bestelltabelle

Nennstrom [A]	Ausgangssignal	Best.-Nr.
50	DC: 0 ... ± 20 mA AC: 0 ... 20 mA (I_{EFF})	1101-10001
100		1101-10003
150		1101-10005
200		1101-10006
250		1101-10007
300		1101-10008

		Best.-Nr.
	Schnappbefestigung Form A	53011
	Quick-Fix Schnellbefestigung	55021



CCT 31.3 U

Allstromsensor (Messumformer) für Gleich- und Wechselstrom

Merkmale / Nutzen

- Messung von sowohl Gleich- als auch Wechselströmen mit nur einem Messwandler möglich
- Beliebige Zeitverläufe des zu messenden Stromes werden proportional dargestellt
- Großer Arbeitsfrequenzbereich von 0 Hz (DC) bis 100 kHz (AC)
- Hohe elektrische Sicherheit durch galvanisch getrennte Erfassung der Messgröße
- Einfache und sichere elektrische Verdrahtung mittels Federzugklemmtechnik
- Direkte Montage auf Stromschienen durch am Gerät integrierte Befestigungsschrauben
- Montage auf 35 mm-DIN-Hutschienen mittels optional lieferbarer Schnappbefestigung möglich
- Hohe klimatische und mechanische Beständigkeit durch PU-Vollverguss aller elektrischen Komponenten

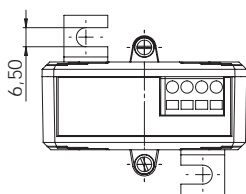
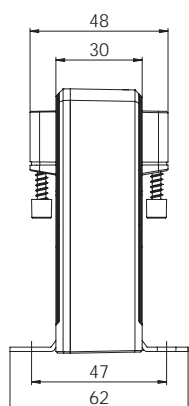
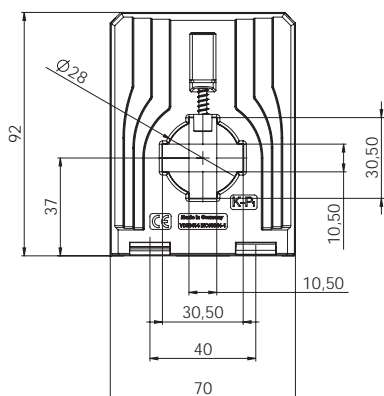

Anwendung

Das einen stromdurchflossenen Leiter umgebende Magnetfeld wird von einem, den Leiter umschließenden, Messkern erfasst. Der im Messkern induzierte, zur Stromstärke im Primärleiter direkt proportionale magnetische Fluss wird mittels eines Halbleiterbauelementes erfasst. Eine im Gerät integrierte Regelelektronik wandelt das vom Halbleiter gelieferte Signal in ein zum zeitlichen Verlauf der Messgröße direkt proportionales Ausgangsstromsignal um.

Durch die induktive, berührungslose Erfassung der Messgröße wird ein galvanisch getrenntes Ausgangssignal bereitgestellt.

Die elektrische Kontaktierung des Sekundärkreises des Stromwandlers erfolgt über eine 4-polige Federzugklemme Reihe 739-104 der Firma WAGO. Diese Klemme ist für den Anschluss flexibler Litzeleitungen bis 2,5 mm² geeignet. Zur Versorgung der Regelelektronik wird eine DC-Hilfsspannungsversorgung von ± 12 V benötigt.

Übertragungsverhalten CCT 31.3U

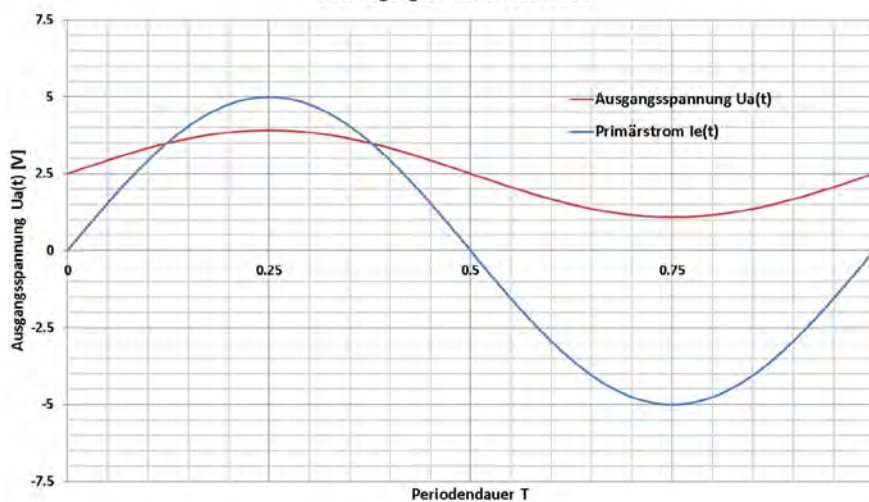



Technische Kennwerte

Elektrische Attribute

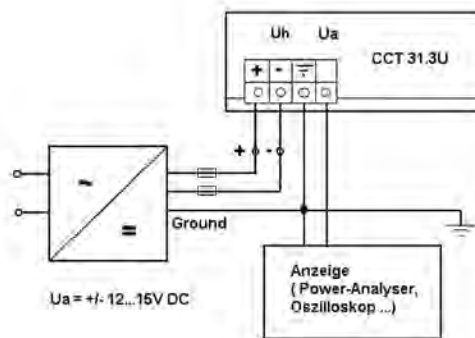

Messbereich	0...300 A DC / AC I_{eff} , varianten-abhängig! (Nennstrombereiche eingestellt auf Normwerte gem. IEC)
Frequenzbereich	0...100 kHz
Spannungsausgang	DC/AC: $2,5 \pm 1$ V; AC: $2,5 +1,0$ V (U_{eff}); $2,5 \pm 1,414$ V (Spitze-Spitze)
Min. Bürdenwiderstand am Stromausgang	> 100 k Ω
Genauigkeit	0,5 %
Max. Betriebsspannung U_m	0,72 kV

Isolationsprüfspannung U_{iso}	6,4 kV, U_{eff} , 50 Hz, 5 s 3 kV, U_{eff} , 50 Hz, 1 min
Hilfsspannung DC	$\pm 12 \dots 15$ V DC, unregelt
Sprungantwortzeit (90 % I_{PN} , $di/dt = 100$ A / μ s)	< 1 μ s
Signalanstiegs-geschwindigkeit di/dt	< 100 A/ μ s
Isolierstoffklasse	E
Schutzklasse	IP 20
Max. Temperatur des Primärleiters	100 °C
Arbeitstemperaturbereich	-25 °C ... +60 °C
Lagertemperaturbereich	-40 °C ... +90 °C
Einsatzhöhe	≤ 2000 m



Bestelltabelle

Nennstrom [A]	Ausgangssignal	Best.-Nr.
50	$U_a = 2,5 \pm 1$ V	1102-10001
100		1102-10003
150		1102-10005
200		1102-10006
250		1102-10007
300		1102-10008

		Best.-Nr.
	Schnappbefestigung Form A	53011
	Quick-Fix Schnellbefestigung	55021





Messumformer für Wechselstrom

Bestellliste

Seite Seite

SWMU	Messumformer mit integriertem Niederspannungs-Stromwandler	314	
NMC	Messumformer zum Aufrasten auf MBS-Niederspannungs-Stromwandler	322	
NMC-AD	Adapter für herstellerunabhängigen Stromwandlereinsatz	325	
NMC-KSx	Kurzschlussadapter	325	
	EMBSIN	326	
EMBSIN 100 I	Messumformer für Wechselstrom, ohne Hilfsspannungsversorgung	328	355
EMBSIN 101 I	Messumformer für Wechselstrom, mit Hilfsspannungsversorgung	329	356
EMBSIN 201 IE	Messumformer für Wechselstrom, Echt-Effektivwert-Messung (RMS)	330	357
EMBSIN 120 U	Messumformer für Wechselspannung, ohne Hilfsspannungsversorgung	331	358
EMBSIN 121 U	Messumformer für Wechselspannung, mit Hilfsspannungsversorgung	332	356
EMBSIN 221 UE	Messumformer für Wechselspannung, Echt-Effektivwert-Messung	334	357
EMBSIN 241 F	Messumformer für Frequenz, mit universellem AC/DC-Netzteil	335	359
EMBSIN 241 FD	Messumformer für Frequenzdifferenz, mit universellem AC/DC-Netzteil	336	359
EMBSIN 271 G	Messumformer für Phasenwinkel, mit universellem AC/DC-Netzteil	338	360
EMBSIN 271 GD	Messumformer für Phasenwinkeldifferenz, mit universellem AC/DC-Netzteil	340	362
EMBSIN 281 G	Messumformer für Leistungsfaktor, mit universellem AC/DC-Netzteil	342	360
EMBSIN 351 P	Messumformer für Wirkleistung, mit universellem AC/DC-Netzteil	344	363
EMBSIN 361 Q	Messumformer für Blindleistung, mit universellem AC/DC-Netzteil	346	363
EMBSIN 301	Programmierbarer Messumformer für Wechselstrom	348	364
MT 440	Programmierbarer Messumformer für alle elektrischen Größen	350	364

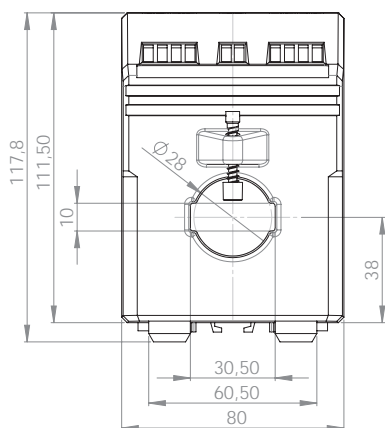

SWMU 31.5

Messumformer für Wechselstrom

Merkmale / Nutzen

- Mit bzw. ohne Hilfsspannungsversorgung
- Mit integriertem Stromwandler
- Aufbaugeschäft für 35 mm DIN-Hutschiene
- Messeingang: Sinusförmiger Wechselstrom (1 A ... 750 A), arithmetische Mittelwertmessung, effektivwertkalibriert
- Messausgang: Unipolare Ausgangsgrößen
- Messprinzip: Gleichrichter-Verfahren
- Reduzierter Verdrahtungsaufwand

Anwendung

Messumformer zur Umwandlung von sinusförmigem Wechselstrom.

Als Ausgangssignal steht ein eingepprägtes Gleichstrom- und aufgeprägtes Gleichspannungssignal zur Verfügung, welches sich proportional zum Messwert der Eingangsgröße verhält.

Diese Signale können zum Anzeigen, Registrieren, Überwachen und/oder Regeln verwendet werden.

Der Messumformer erfüllt die Anforderungen und Vorschriften hinsichtlich elektromagnetischer Verträglichkeit (EMV) und Sicherheit (IEC 1010 bzw. EN 61010). Seine Fertigung erfolgt in Übereinstimmung mit den technischen Anforderungen der Norm IEC 60688.

Befestigungssockel zur direkten Montage ohne Verwendung einer 35 mm DIN-Hutschiene im Lieferumfang enthalten.

Technische Kennwerte

Messeingang	
Nennfrequenz f_N	50/60 Hz
Eingangsnennstrom I_N	1...10 A (SWMU 31.52/32.52) 15...750 A (SWMU 31.51/32.51)
Eigenverbrauch	≤ 1 VA (2,5 VA ohne Hilfsspannung)
Überlastbarkeit	1,5 x I_N , dauernd 8 x I_N , 40 Sek.
Messausgang	
Stromausgang	
Eingepprägter Gleichstrom	0(4) ... 20 mA
Max. Bürdenwiderstand	$\leq 500 \Omega$
Max. Bürdenspannung	≤ 15 V
Strombegrenzung bei Überlast	≤ 34 mA
Spannungsausgang	
Aufgeprägte Gleichspannung	0(2) ... 10 V
Min. Bürdenwiderstand	≥ 10 k Ω
Max. Bürdenspannung bei Übersteuerung	≤ 18 V
Spannungsbegrenzung bei $R_{EXT} = \infty$	≤ 18 V
Restwelligkeit des Ausgangsstromes	≤ 1 % p.p.

Einstellzeit	≤ 500 ms
Arbeitstemperaturbereich	-5 °C bis +40 °C
Genauigkeit	
Bezugswert	Ausgangsendwert
Grundgenauigkeit	0,5 %
Anwärmzeit	≤ 5 min
Hilfsenergie	
AC-Netzteil	230 V ± 10 % (50...60 Hz)
DC	24 V ± 15 %
Leistungsaufnahme	$\leq 1,5$ W (2,5 VA)
Sicherheit	
Berührungsschutz	IP 40, Gehäuse (Prüfdraht, EN 60529) IP 20, Anschlussklemmen (Prüffinger, EN 60529)
Verschmutzungsgrad	
Verschmutzungsgrad	2
Prüfspannungen (DIN 57411)	4 kV, aktive Kreise gegen Gehäuse 4 kV, Hilfsspannung gegen Messausgang (230 V AC-Version) 500 V, Hilfsspannung gegen Messausgang (24 V DC-Version)



Hilfsspannung 230 V AC



Schiene 30 x 10 mm
 Rundleiter 28 mm
 Baubreite 80 mm
 Bauhöhe 117,8 mm
 Bautiefe gesamt 71 mm
 Gewicht 350 g
 Arbeitsbereich 0 ... 120 % I_N

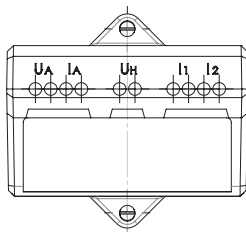
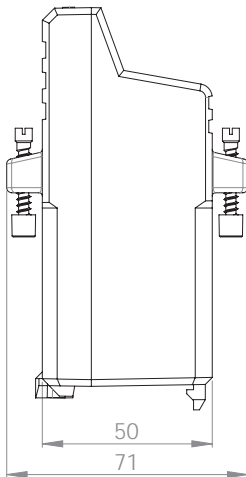
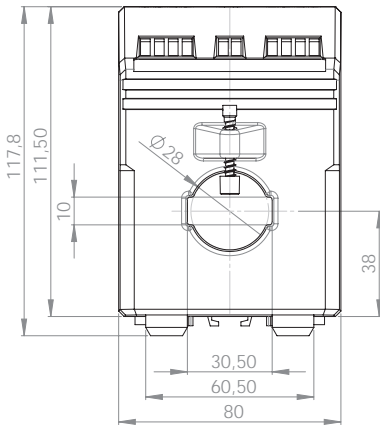

SWMU-Typ	Primärstrom A	0...20 mA 0...10 V Best.-Nr.	4...20 mA 0...10 V Best.-Nr.	0...20 mA 2...10 V Best.-Nr.	4...20 mA 2...10 V Best.-Nr.
31.52	1	31-1006	31-2006	31-3006	31-4006
	5	31-1007	31-2007	31-3007	31-4007
	10	31-1008	31-2008	31-3008	31-4008
31.51	15	31-1009	31-2009	31-3009	31-4009
	20	31-1010	31-2010	31-3010	31-4010
	25	31-1011	31-2011	31-3011	31-4011
	30	31-1012	31-2012	31-3012	31-4012
	40	31-1013	31-2013	31-3013	31-4013
	50	31-1014	31-2014	31-3014	31-4014
	60	31-1015	31-2015	31-3015	31-4015
	75	31-1016	31-2016	31-3016	31-4016
	100	31-1017	31-2017	31-3017	31-4017
	150	31-1018	31-2018	31-3018	31-4018
	200	31-1019	31-2019	31-3019	31-4019
	250	31-1020	31-2020	31-3020	31-4020
	300	31-1021	31-2021	31-3021	31-4021
	400	31-1022	31-2022	31-3022	31-4022
	500	31-1023	31-2023	31-3023	31-4023
600	31-1024	31-2024	31-3024	31-4024	
750	31-1025	31-2025	31-3025	31-4025	

- Für Nennstrombereiche < 15 A (SWMU 31.52) muss der primärseitige Anschluss des Messumformers über die im Kopfbereich angeordneten Anschlussklemmen „K-L“ erfolgen.
- Bei Nennströmen ≥ 15 A (SWMU 31.51) erfolgt die primärseitige Anbindung durch Hindurchführen des Primärleiters durch das Primärleiterfenster.

SWMU 31.51

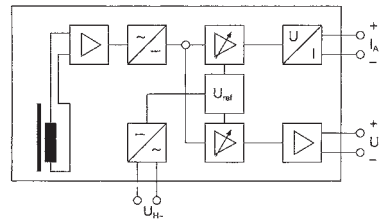

SWMU 31.52

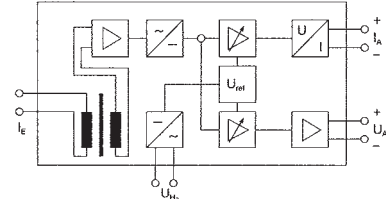

SWMU

NMC

NMC-AD

NMC-KSX

EMBSIN

MT

Bestelllisten



Hilfsspannung 24V DC



Schiene 30 x 10 mm
 Rundleiter 28 mm
 Baubreite 80 mm
 Bauhöhe 117,8 mm
 Bautiefe gesamt 71 mm
 Gewicht 250 g
 Arbeitsbereich 0 ... 120 % I_N

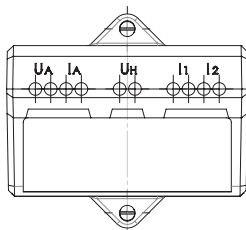
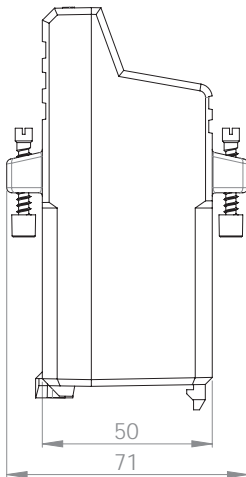
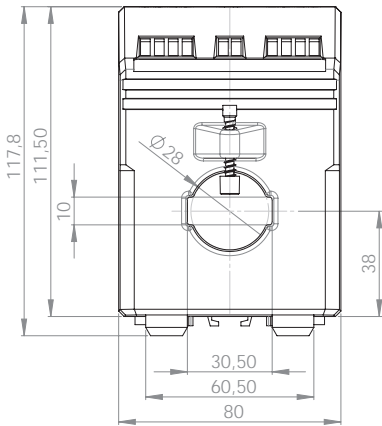

SWMU-Typ	Primärstrom A	0...20 mA 0...10 V Best.-Nr.	4...20 mA 0...10 V Best.-Nr.	0...20 mA 2...10 V Best.-Nr.	4...20 mA 2...10 V Best.-Nr.
31.52	1	31-5006	31-6006	31-7006	31-8006
	5	31-5007	31-6007	31-7007	31-8007
	10	31-5008	31-6008	31-7008	31-8008
31.51	15	31-5009	31-6009	31-7009	31-8009
	20	31-5010	31-6010	31-7010	31-8010
	25	31-5011	31-6011	31-7011	31-8011
	30	31-5012	31-6012	31-7012	31-8012
	40	31-5013	31-6013	31-7013	31-8013
	50	31-5014	31-6014	31-7014	31-8014
	60	31-5015	31-6015	31-7015	31-8015
	75	31-5016	31-6016	31-7016	31-8016
	100	31-5017	31-6017	31-7017	31-8017
	150	31-5018	31-6018	31-7018	31-8018
	200	31-5019	31-6019	31-7019	31-8019
	250	31-5020	31-6020	31-7020	31-8020
	300	31-5021	31-6021	31-7021	31-8021
	400	31-5022	31-6022	31-7022	31-8022
	500	31-5023	31-6023	31-7023	31-8023
600	31-5024	31-6024	31-7024	31-8024	
750	31-5025	31-6025	31-7025	31-8025	

- Für Nennstrombereiche < 15 A (SWMU 31.52) muss der primärseitige Anschluss des Messumformers über die im Kopfbereich angeordneten Anschlussklemmen „K-L“ erfolgen.
- Bei Nennströmen ≥ 15 A (SWMU 31.51) erfolgt die primärseitige Anbindung durch Hindurchführen des Primärleiters durch das Primärleiterfenster.

SWMU 31.51

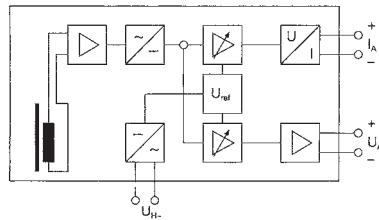

SWMU 31.52

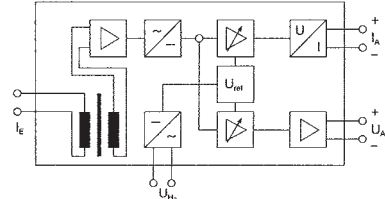



Ohne Hilfsspannungsversorgung



Schiene	30 x 10 mm
Rundleiter	28 mm
Baubreite	80 mm
Bauhöhe	117,8 mm
Bautiefe gesamt	71 mm
Gewicht	600 g
Eigenverbrauch	≥ 2,5 VA
Arbeitsbereich	15 ... 120 % I _N

SWMU-Typ	Primärstrom A	0...20 mA 0...10 V Best.-Nr.
32.52	1	31-9006
	5	31-9007
	10	31-9008
32.51	40	31-9013
	50	31-9014
	60	31-9015
	75	31-9016
	100	31-9017
	150	31-9018
	200	31-9019
	250	31-9020
	300	31-9021
	400	31-9022
	500	31-9023
600	31-9024	
750	31-9025	

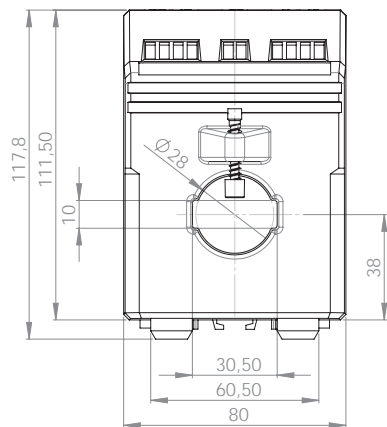

- Für Nennstrombereiche ≤ 10A (SWMU 32.52) muss der primärseitige Anschluss des Messumformers über die im Kopfbereich angeordneten Anschlussklemmen „K-L“ erfolgen.
- Bei Nennströmen ≥ 40 A (SWMU 31.51) erfolgt die primärseitige Anbindung durch Hindurchführen des Primärleiters durch das Primärleiterfenster.

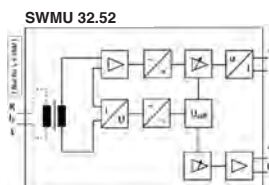
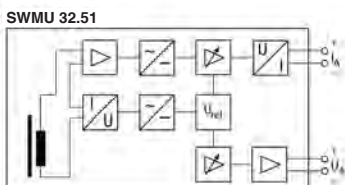
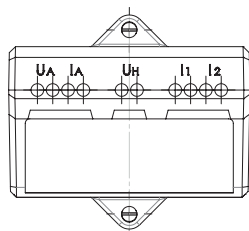
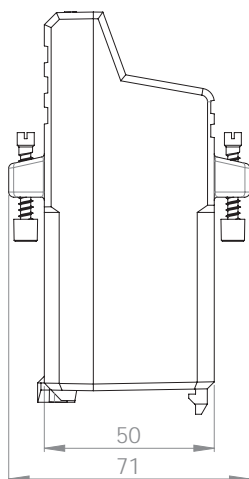

SWMU

NMC

NMC-AD

NMC-KSX

EMBSIN

MT

Bestelllisten



SWMU 41.5

Messumformer für Wechselstrom

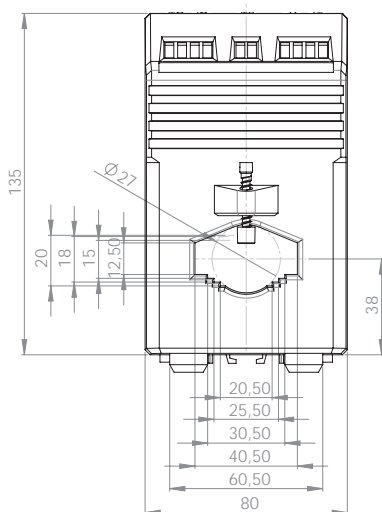

Merkmale / Nutzen

- Mit bzw. ohne Hilfsspannungsversorgung
- Mit integriertem Stromwandler
- Aufbaugeschäft für 35 mm DIN-Hutschiene
- Messeingang: Sinusförmiger Wechselstrom (1 A ... 800 A), arithmetische Mittelwertmessung, effektivwertkalibriert
- Messausgang: Unipolare Ausgangsgrößen
- Messprinzip: Gleichrichter-Verfahren
- Reduzierter Verdrahtungsaufwand

Anwendung

Messumformer zur Umwandlung von sinusförmigem Wechselstrom.

Als Ausgangssignal steht ein eingepprägtes Gleichstrom- und aufgeprägtes Gleichspannungssignal zur Verfügung, welches sich proportional zum Messwert der Eingangsgröße verhält.

Diese Signale können zum Anzeigen, Registrieren, Überwachen und/oder Regeln verwendet werden.

Der Messumformer erfüllt die Anforderungen und Vorschriften hinsichtlich elektromagnetischer Verträglichkeit (EMV) und Sicherheit (IEC 1010 bzw. EN 61010). Seine Fertigung erfolgt in Übereinstimmung mit den technischen Anforderungen der Norm IEC 60688.

Befestigungssockel zur direkten Montage ohne Verwendung einer 35 mm DIN-Hutschiene im Lieferumfang enthalten.

Technische Kennwerte

Messeingang	
Nennfrequenz f_N	50/60 Hz
Eingangsnennstrom I_N	1...10 A (SWMU 41.52/42.52) 15...800 A (SWMU 41.51/42.51)
Eigenverbrauch	≤ 1 VA (2,5 VA ohne Hilfsspannung)
Überlastbarkeit	$1,5 \times I_N$, dauernd $8 \times I_N$, 40 Sek.
Messausgang	
Stromausgang	
Eingepprägter Gleichstrom	0(4) ... 20 mA
Max. Bürdenwiderstand	$\leq 500 \Omega$
Max. Bürdenspannung	≤ 15 V
Strombegrenzung bei Überlast	≤ 34 mA
Spannungsausgang	
Aufgeprägtes Gleichspannung	0(2) ... 10 V
Min. Bürdenwiderstand	≥ 10 k Ω
Max. Bürdenspannung bei Übersteuerung	≤ 18 V
Spannungsbegrenzung bei $R_{EXT} = \infty$	≤ 18 V
Restwelligkeit des Ausgangsstromes	≤ 1 % p.p.

Einstellzeit	≤ 500 ms
Arbeitstemperaturbereich	-5 °C bis +40 °C
Genauigkeit	
Bezugswert	Ausgangsendwert
Grundgenauigkeit	0,5 %
Anwärmzeit	≤ 5 min
Hilfsenergie	
AC-Netzteil	230 V \pm 10% (50 ... 60 Hz)
DC	24 V \pm 15%
Leistungsaufnahme	$\leq 1,5$ W (2,5 VA)
Sicherheit	
Berührungsschutz	IP 40, Gehäuse (Prüfdraht, EN 60529) IP 20, Anschlussklemmen (Prüffinger, EN 60529)
Verschmutzungsgrad	2
Prüfspannungen (DIN 57411)	4 kV, aktive Kreise gegen Gehäuse 4 kV, Hilfsspannung gegen Messausgang (230 V AC-Version) 500 V, Hilfsspannung gegen Messausgang (24 V DC-Version)



Hilfsspannung 230 V AC



Schiene 40 x 12 mm
 Rundleiter 27 mm
 Baubreite 80 mm
 Bauhöhe 135 mm
 Bautiefe gesamt 71 mm
 Gewicht 350 g
 Arbeitsbereich 0 ... 120 % I_N

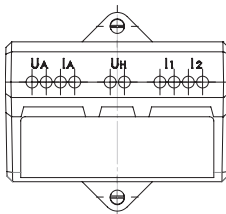
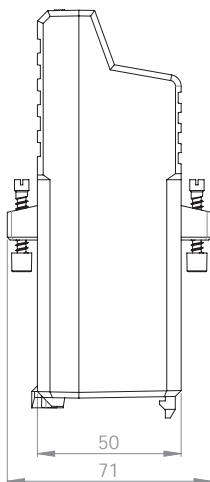
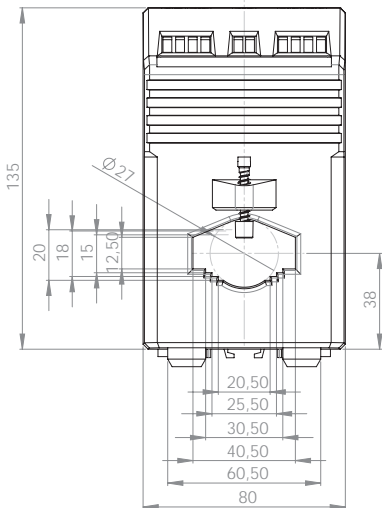

SWMU-Typ	Primärstrom A	0...20 mA 0...10 V Best.-Nr.	4...20 mA 0...10 V Best.-Nr.	0...20 mA 2...10 V Best.-Nr.	4...20 mA 2...10 V Best.-Nr.
41.52	1	61006	62006	63006	64006
	5	61007	62007	63007	64007
	10	61008	62008	63008	64008
41.51	15	61009	62009	63009	64009
	20	61010	62010	63010	64010
	25	61011	62011	63011	64011
	30	61012	62012	63012	64012
	40	61013	62013	63013	64013
	50	61014	62014	63014	64014
	60	61015	62015	63015	64015
	75	61016	62016	63016	64016
	100	61017	62017	63017	64017
	150	61018	62018	63018	64018
	200	61019	62019	63019	64019
	250	61020	62020	63020	64020
	300	61021	62021	63021	64021
	400	61022	62022	63022	64022
	500	61023	62023	63023	64023
600	61024	62024	63024	64024	
750	61025	62025	63025	64025	
800	61026	62026	63026	64026	

- Für Nennstrombereiche < 15 A (SWMU 41.52) muss der primärseitige Anschluss des Messumformers über die im Kopfbereich angeordneten Anschlussklemmen „K-L“ erfolgen.
- Bei Nennströmen ≥ 15 A (SWMU 41.51) erfolgt die primärseitige Anbindung durch Hindurchführen des Primärleiters durch Primärleiterfenster.

SWMU 41.51

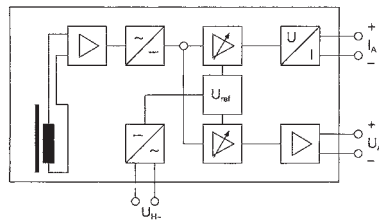

SWMU 41.52

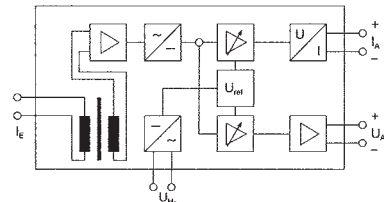

SWMU

NMC

NMC-AD

NMC-KSX

EMBSIN

MT

Bestelllisten



Hilfsspannung 24V DC



Schiene 40 x 12 mm
 Rundleiter 27 mm
 Baubreite 80 mm
 Bauhöhe 135 mm
 Bautiefe gesamt 71 mm
 Gewicht 250 g
 Arbeitsbereich 0 ... 120 % I_N

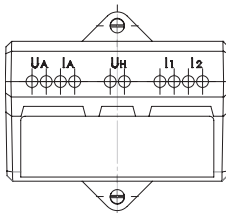
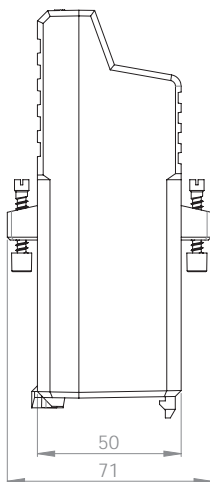
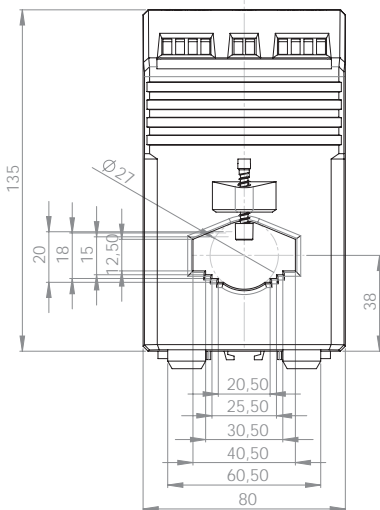

SWMU-Typ	Primärstrom A	0...20 mA 0...10 V Best.-Nr.	4...20 mA 0...10 V Best.-Nr.	0...20 mA 2...10 V Best.-Nr.	4...20 mA 2...10 V Best.-Nr.
41.52	1	65006	66006	67006	68006
	5	65007	66007	67007	68007
	10	65008	66008	67008	68008
41.51	15	65009	66009	67009	68009
	20	65010	66010	67010	68010
	25	65011	66011	67011	68011
	30	65012	66012	67012	68012
	40	65013	66013	67013	68013
	50	65014	66014	67014	68014
	60	65015	66015	67015	68015
	75	65016	66016	67016	68016
	100	65017	66017	67017	68017
	150	65018	66018	67018	68018
	200	65019	66019	67019	68019
	250	65020	66020	67020	68020
	300	65021	66021	67021	68021
	400	65022	66022	67022	68022
	500	65023	66023	67023	68023
600	65024	66024	67024	68024	
750	65025	66025	67025	68025	
800	65026	66026	67026	68026	

- Für Nennstrombereiche < 15 A (SWMU 41.52) muss der primärseitige Anschluss des Messumformers über die im Kopfbereich angeordneten Anschlussklemmen „K-L“ erfolgen.
- Bei Nennströmen ≥ 15 A (SWMU 41.51) erfolgt die primärseitige Anbindung durch Hindurchführen des Primärleiters durch das Primärleiterfenster.

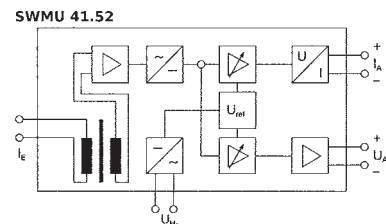
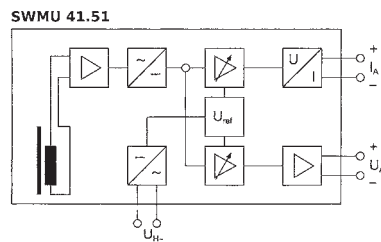



Ohne Hilfsspannungsversorgung



Schiene	40 x 12 mm
Rundleiter	27 mm
Baubreite	80 mm
Bauhöhe	135 mm
Bautiefe gesamt	71 mm
Gewicht	600 g
Eigenverbrauch	≥ 2,5 VA
Arbeitsbereich	15 ... 120 % I _N

SWMU-Typ	Primärstrom A	0...20 mA 0...10 V Best.-Nr.
42.52	1	69006
	5	69007
	10	69008
42.51	40	69013
	50	69014
	60	69015
	75	69016
	100	69017
	150	69018
	200	69019
	250	69020
	300	69021
	400	69022
	500	69023
	600	69024
	750	69025
800	69026	

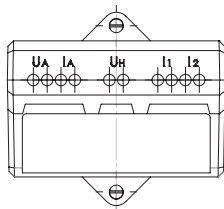
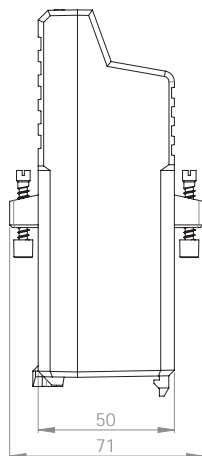
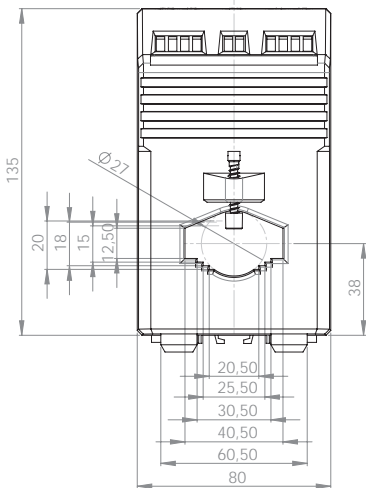

- Für Nennstrombereiche ≤ 10 A (SWMU 41.52) muss der primärseitige Anschluss des Messumformers über die im Kopfbereich angeordneten Anschlussklemmen „K-L“ erfolgen.
- Bei Nennströmen ≥ 40 A (SWMU 41.51) erfolgt die primärseitige Anbindung durch Hindurchführen des Primärleiters durch das Primärleiterfenster.

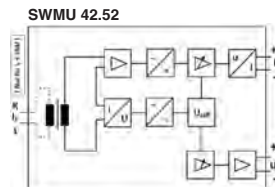
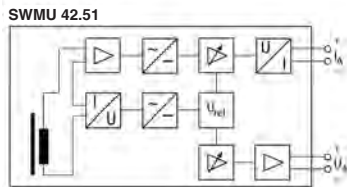

SWMU

NMC

NMC-AD

NMC-KSX

EMBSIN

MT

Bestelllisten



NMC

Messumformer für Wechselstrom

Merkmale / Nutzen

- Aufrastbarer Messumformer für MBS Stromwandler in Modulbauweise
- Versionen mit bzw. ohne Hilfsspannungsversorgung
- Messeingang: Sinusförmiger Wechselstrom (1 oder 5 A), arithmetische Mittelwertmessung, effektivwertkalibriert
- Messausgänge: Unipolare Ausgangsgrößen
- Messprinzip: Gleichrichter-Verfahren
- Direkte Kontaktierung mit MBS Stromwandlern über Kontaktstifte
- Geringer Verdrahtungsaufwand

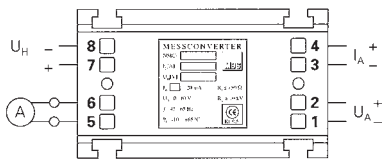

Anwendung

Messumformer zur Erfassung von sinusförmigem Wechselstrom.

Als Ausgangssignal steht ein eingepprägtes Gleichstrom- und aufgeprägtes Gleichspannungssignal zur Verfügung, welches sich proportional zum Messwert der Eingangsgröße verhält.

Diese Signale können zum Anzeigen, Registrieren, Überwachen und/oder Regeln verwendet werden. Gleichzeitig kann der Sekundärstrom des Stromwandlers zum Betrieb konventioneller Zeigerinstrumente verwendet werden.

Der Messumformer erfüllt die Anforderungen und Vorschriften hinsichtlich elektromagnetischer Verträglichkeit (EMV) und Sicherheit IEC 1010 bzw. EN 61010.

Die Fertigung erfolgt in Übereinstimmung mit den technischen Anforderungen der Norm IEC 60688.

Technische Kennwerte

Messeingang

Nennfrequenz f_N	50/60 Hz
Eingangsnennstrom I_N	1 oder 5 A
Leistungsaufnahme aus Messkreis	≤ 1 VA (2,5 VA ohne Hilfsspannung)
Überlastbarkeit	$1,2 \times I_N$, dauernd $8 \times I_N$, 40 Sek.

Messausgang

Stromausgang	
Eingepprägter Gleichstrom	0(4) ... 20 mA
Max. Bürdenwiderstand	$\leq 500 \Omega$
Max. Bürdenspannung	≤ 15 V
Strombegrenzung bei Überlast	≤ 34 mA
Restwelligkeit des Ausgangsstromes	≤ 1 % p.p.
Spannungsausgang	
Aufgeprägte Gleichspannung	0(2) ... 10 V
Min. Bürdenwiderstand	≥ 10 k Ω
Max. Bürdenspannung bei Übersteuerung	≤ 18 V
Einstellzeit	< 500 ms

Genauigkeit

Bezugswert	Ausgangsendwert
Grundgenauigkeit	0,5 %
Genauigkeitsbereich	1...120 % I_N (NMC 2/3/4) 15...120 % I_N (NMC 0)

Anwärmzeit ≤ 5 min

Hilfsenergie

AC-Netzteil 230 V ± 10 % (50...60 Hz) oder 110 V ± 10 % (50...60 Hz)

DC 24 V ± 15 %

Leistungsaufnahme $\leq 1,5$ W (2,5 VA)

Sicherheit

Berührungsschutz IP 40, Gehäuse (Prüfdraht, EN 60529)
IP 20, Anschlussklemmen (Prüffinger, EN 60529)

Verschmutzungsgrad

2
Prüfspannungen (DIN 57411) 4 kV, aktive Kreise gegen Gehäuse
4 kV, Hilfsspannung gegen Messausgang (230 V AC-Version)
500 V, Hilfsspannung gegen Messausgang (24 V DC-Version)



MBS AG



Bauform „A“

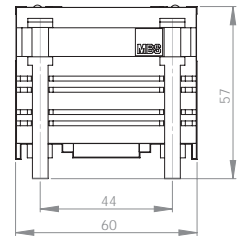
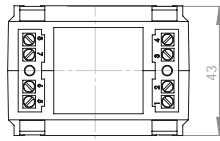
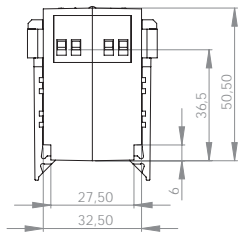

Bauform „B“/„C“

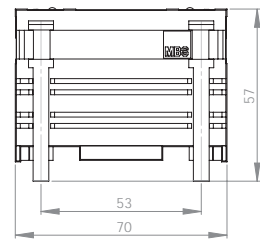
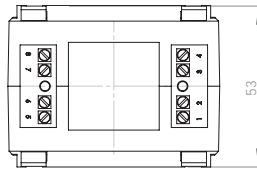
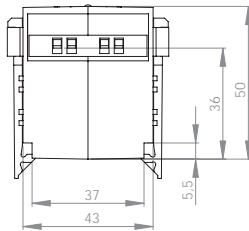

Bauform „D“

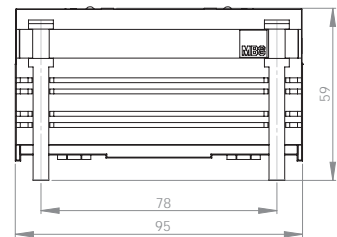
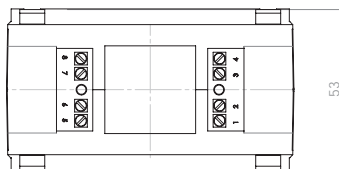
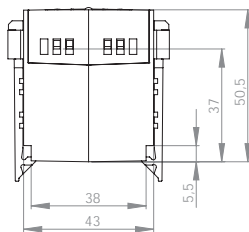

SW/MU

NMC

NMC-AD

NMC-KSx

EMBSIN

MT

Bestelllisten



Hilfsspannung 24 V DC galvanisch getrennt

Primärstrom A	0...20 mA 0...10 V Best.-Nr.	4...20 mA 0...10 V Best.-Nr.	4...20 mA 2...10 V Best.-Nr.	Passend für Stromwandler der Bauform
1	39212	39232	39252	A
	39213	39233	39253	B
	39214	39234	39254	C
	39215	39235	39255	D
5	39012	39032	39052	A
	39013	39033	39053	B
	39014	39034	39054	C
	39015	39035	39055	D

Hilfsspannung 230 V AC galvanisch getrennt

Primärstrom A	0...20 mA 0...10 V Best.-Nr.	4...20 mA 0...10 V Best.-Nr.	4...20 mA 2...10 V Best.-Nr.	Passend für Stromwandler der Bauform
1	36212	36232	36252	A
	36213	36233	36253	B
	36214	36234	36254	C
	36215	36235	36255	D
5	36041	36032	36052	A
	36042	36033	36053	B
	36043	36034	36054	C
	36044	36035	36055	D

Hilfsspannung 110 V AC galvanisch getrennt

Primärstrom A	0...20 mA 0...10 V Best.-Nr.	4...20 mA 0...10 V Best.-Nr.	4...20 mA 2...10 V Best.-Nr.	Passend für Stromwandler der Bauform
1	76212	76232	76252	A
	76213	76233	76253	B
	76214	76234	76254	C
	76215	76235	76255	D
5	76012	76032	76052	A
	76013	76033	76053	B
	76014	76034	76054	C
	76015	76035	76055	D

Ohne Hilfsspannungsversorgung,
Eigenleistungsbedarf $\geq 2,5$ VA

Primärstrom A	0...20 mA 0...10 V Best.-Nr.	Passend für Stromwandler der Bauform
1	37212	A
	37213	B
	37214	C
	37215	D
5	37012	A
	37013	B
	37014	C
	37015	D



NMC Auswahltablelle

Primärstrom A	Bauform													
	A				B		C				D			
1														
5														
10						WSK 30								
15							WSK 40							
20														
25														
30														
40														
50														
60														
75														
80														
100														
125														
150														
200														
250														
300														
400														
500														
600														
750														
800														
1000														
1200														
1250														
1500														
1600														
2000														
2500														
3000														

NMC-AD

Adapter für herstellerunabhängigen Stromwandler-einsatz aufrastbar auf 35-mm-DIN-Hutschiene

Merkmale/Nutzen

- Herstellerunabhängiger Einsatz von Stromwandlern in Verbindung mit Messumformer des Typs NMC
- Montage des Messumformers in räumlicher Trennung zur Messstelle unter Verwendung einer genormten 35-mm-DIN-Hutschiene



Bestellübersicht	Anwendung mit NMC Best.-Nr.
36011	39xx2; 36xx1/2; 37xx2; 76xx2

Gewicht: 70 g

Anschlussbelegung	Beschreibung
6, 7	Eingangsklemmen 5 A oder 1 A (vom Stromwandler kommend)

Kurzschlussadapter NMC-KSx



Verwendungszweck

Adapter NMC-KSx werden auf Stromwandler aufgerastet. Bei Nichtbeschaltung des Sekundärkreises eines Stromwandlers verhindern sie den Wandlerleerlauf und somit das Auftreten hoher Leerlaufspannungen im Nennstrombereich des Stromwandlers.

Typ	Best.-Nr.	Einsetzbar mit MBS-Stromwandler-Typen													Bauform
		WSK 30	WSK 40	ASR 22.3	ASK 21.3	ASK 31.3	ASK 41.3	ASK 41.4	ASK 421.4	ASK 61.4	ASK 63.4	ASK 81.4	ASK 101.4	ASK 105.6	
NMC-KSx															
0	39090	•		•	•	•	•								
1	39091		•												
2	39092							•	•						
3	39093									•	•	•	•	•	

SW/MU
 NMC
 NMC-AD
 NMC-KSx
 EMBSIN
 MT
 Bestelllisten

EMBSIN

Messumformer für elektrische Größen



MBS-Messumformer der EMBSIN-Baureihe setzen eine Eingangswechselspannung und/oder einen Eingangswechselstrom, welche als Standard-Signal von einem Strom- oder Spannungswandler oder direkt aus dem Starkstromnetz kommen, in einen eingepprägten Ausgangsstrom oder eine aufgeprägten Ausgangsspannung um.

Die verschiedenen EMBSIN-Geräte ermöglichen es, alle Messgrößen zu erfassen, welche notwendig sind, um elektrische Netze und Verbraucher zu überwachen, zu steuern, die Ausgangsgrößen anzuzeigen oder in andere Geräte der Mess- und Regeltechnik zu übernehmen.

Am Ausgang können mehrere Geräte wie Anzeiger, Schreiber oder signalverarbeitende Anlagen angeschlossen werden.

Die Konzeption der Geräte gewährleistet für alle Funktionen eine sichere, galvanische Trennung zwischen den Ein- und Ausgängen.

Die Haupteinsatzgebiete der Messumformer sind in der Energieerzeugung, der Energieverteilung, sowie im Anlagen- und Apparatebau zu finden.

Alle Geräte basieren auf einer völlig neu konzipierten Gehäusetechnik in jetzt fünf verschiedenen Gehäusebreiten. Das verwendete Gehäusematerial – ein hochwertiges Polycarbonat – gewährleistet, dass die Geräte **silikon- und halogenfrei** sowie schwer entflammbar sind. Eingänge und Ausgänge sind sicher mit hochwertigen Schraubklemmen anschließbar.

Die Befestigung an der Montagewand erfolgt generell über eine 35-mm-DIN-Hutschiene.

Alle elektrischen Anschlüsse sind auf der „Oberseite“ der Geräte sicher und leicht zugänglich.

Die Geräte tragen das CE-Zeichen.

Sie bieten höchstmöglichen Schutz für Mensch, Maschine und Umwelt und halten selbstverständlich alle einschlägigen Sicherheitsvorschriften ein.

Die Fertigung qualitativ hochwertiger Starkstrommessumformer hat im Hause MBS eine jahrelange Tradition und einen europaweit ausgezeichneten Ruf.

Die Messumformer sind durch ihr geschlossenes Gehäuse, die Wahl der Materialien und der Konstruktionsprinzipien gegen Einwirkungen von Klima (Temperatur und Feuchtigkeit), Atmosphäre (chemische Prozesse, Staub und Salzgehalt), Erschütterungen und Stöße, Störfelder (elektrisch und magnetisch), HF-Einflüsse (Funksprechgeräte) sowie permanente oder transiente Störspannungen an allen elektrischen Anschlüssen geschützt.



• Kompakt • Sicher • Praxisgerecht • Genau • Besser

Sicher

EN 61010 auch an den Klemmen!
690 V max. Eingangsspannung
Gehäusematerial Polycarbonat
Brennbarkeitsklasse V-0 nach UL94
(selbstverlöschend, halogenfrei, silikonfrei)

Praxisgerecht

Geräte mit zwei Weitbereichs-Hilfsenergiebereichen
24...65 V AC/DC oder 85...230 V AC/DC
Hilfsenergie wahlweise oben oder unten anschließbar!
cos φ oder -linear
Nachkalibrieren / abstimmen ohne Geräteöffnung und
ohne AC-Kalibratoren!
Montage auf 35-mm-DIN-Hutschiene
Betriebsanleitungen liegen dem Gerät bei.

Kompakt

Bauhöhe 60 mm
Bautiefe 112 mm
Baubreite 105 mm für Leistung,
70 mm für Frequenz und Phase
sowie U und I mit Weitbereichs-
Hilfsenergie,
35 mm mit Zweidrahtspeisung,
24 V DC oder 230 V AC,
35 mm für Strom und Spannung
ohne Hilfsspannungsversorgung

Genau

Alle Geräte Klasse 0,5
EMBSIN 241 F Klasse 0,2
EMBSIN 241 FD Klasse 0,2

Besser

Höchste Qualität und Sicherheit zu marktgerechten Preisen!

Montage

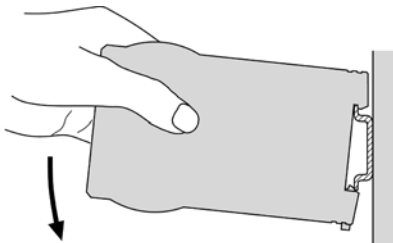

Demontage

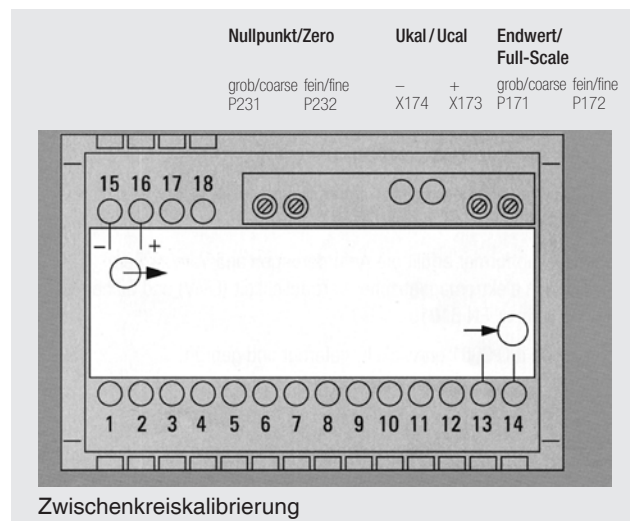
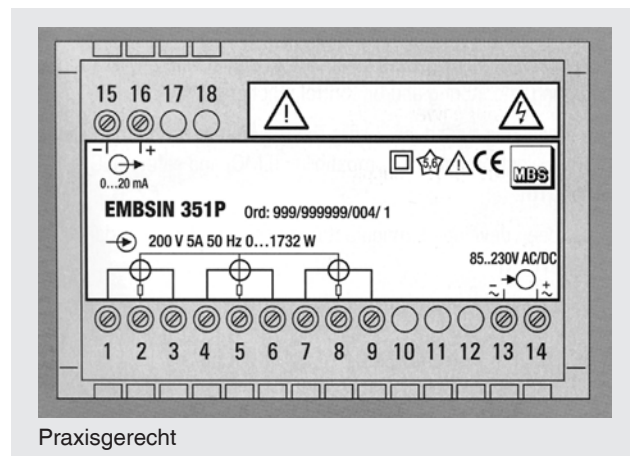
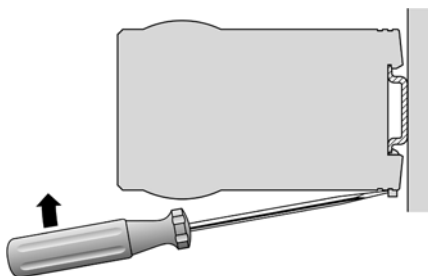



EMBSIN 100 I

Messumformer für Wechselstrom

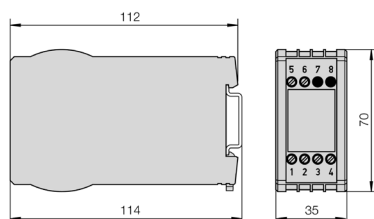

Merkmale / Nutzen

- Ohne Hilfsspannungsversorgung
- Zwei über Eingangsklemmen wählbare Messbereiche
- Aufbaugehäuse für 35 mm DIN-Hutschiene
- Messgröße: Sinusförmiger Wechselstrom (0...1/5 A oder 0...1,2/6 A, umklemmbar), arithmetische Mittelwertmessung, effektivwertkalibriert
- Messausgang: Unipolare Ausgangsgrößen
- Messprinzip: Gleichricht-Mittelwert-Messverfahren
- Geringer Verdrahtungsaufwand

Anwendung

Messumformer zur Umwandlung von sinusförmigem Wechselstrom. Als Ausgangssignal steht ein eingepprägtes, dem Messwert der Eingangsgröße proportionales Gleichstromsignal zur Verfügung, das zum Anzeigen, Registrieren, Überwachen und/oder Regeln dient.

Der Messumformer erfüllt alle Anforderungen und Vorschriften hinsichtlich elektromagnetischer Verträglichkeit (EMV) und Sicherheit (IEC 1010 bzw. EN 61010). Die Messumformer sind zum ausschließlichen Einsatz in Innenräumen bestimmt.

Technische Kennwerte

Messeingang	
Nennfrequenz f_N	50 / 60 Hz
Eingangsnennstrom I_N	1 / 5 A oder 1,2 / 6 A, umklemmbar
Eigenverbrauch	$\leq 2,5$ VA
Überlastbarkeit	1,2 x I_N , dauernd 20 x I_N , 1 Sek.
Messausgang	
Eingepprägter Gleichstrom	0...5 mA, 0...10 mA oder 0...20 mA
Max. Bürdenspannung	≤ 15 V
Spannungsbegrenzung bei $R_{EXT} = \infty$	≤ 30 V
Strombegrenzung bei Überlast	≤ 34 mA
Restwelligkeit des Ausgangsstromes	$\leq 1\%$ p.p.
Einstellzeit	≤ 300 ms
Genauigkeit	
Bezugswert	Ausgangsendwert
Grundgenauigkeit	Klasse 0,5
Messbereich	0...100% I_N

Temperatureinfluss (-10 ... +55 °C)	0,2% / 10 K
Arbeitstemperaturbereich	-10 °C bis +55 °C
Lagertemperaturbereich	-40 °C bis +70 °C
Sicherheit	
Schutzklasse	II, (schutzisoliert, DIN EN 61010)
Berührungsschutz	IP 40, Gehäuse (Prüfdraht, EN 60529) IP 20, Anschlussklemmen (Prüffinger, EN 60529)
Verschmutzungsgrad	2
Überspannungskategorie	III
Nennisolationsspannung (gegen Erde)	250 V, Eingang 40 V, Ausgang
Prüfspannung	50 Hz, 1 min, EN 61010-1 3,7 kV, rms, Messeingang gegen Messausgang sowie Außenfläche 490 V, Messausgang gegen Außenfläche
Gewicht	270 g

Bestelltabelle siehe Seite 354



EMBSIN 101 I

Messumformer für Wechselstrom

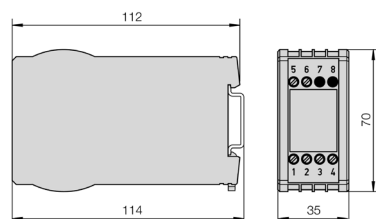

Merkmale / Nutzen

- Mit Hilfsspannungsversorgung
- Optional mit Messausgang 4 ... 20 mA und/oder 2-Drahttechnik
- Aufbaugehäuse für 35 mm DIN-Hutschiene
- Messeingang: Sinusförmiger Wechselstrom, arithmetische Mittelwertmessung, effektivwertkalibriert
- Messausgang: Unipolare und live-zero Ausgangsgrößen
- Messprinzip: Gleichrichter-Verfahren
- AC oder DC Hilfsenergie

Anwendung

Messumformer zur Umwandlung von sinusförmigem Wechselstrom. Als Ausgangssignal steht ein eingepprägtes Gleichstrom- oder aufgeprägtes Gleichspannungssignal zur Verfügung, welches sich proportional zum Messwert der Eingangsgröße verhält.

Der Messumformer erfüllt alle Anforderungen und Vorschriften hinsichtlich elektromagnetischer Verträglichkeit (EMV) und Sicherheit (IEC 1010 bzw. EN 61010). Die Messumformer sind zum ausschließlichen Einsatz in Innenräumen bestimmt.

Technische Kennwerte

Messeingang	
Nennfrequenz f_N	50 / 60 Hz
Eingangsnennstrom I_N	0...1 A bzw. 0...5 A optional: 0...1,2 A bzw. 0...6 A
Eigenverbrauch	$\leq 5 \text{ mV} \times I_N$
Überlastbarkeit	$2 \times I_N$, dauernd
Messausgang	
Stromausgang	
Eingepprägter Gleichstrom	0...2,5 mA bis 0...20 mA bzw. live-zero 1...5 mA bis 4...20 mA
Max. Bürdenspannung	$\leq 15 \text{ V}$
Bei 2-Drahtanschluss	Normbereich 4...20 mA Außenwiderstand R_{ext} abhängig von der Hilfsenergie H (12...32 V DC) $R_{\text{EXT}} [\text{k}\Omega] \leq (H-12) \text{ V} / 20 \text{ mA}$
Spannungsausgang (optional)	
Aufgeprägte Gleichspannung	0...5 V bis 0...10 V bzw. live-zero 1...5 V bis 2...10 V
Belastbarkeit	max. 20 mA
Spannungsbegrenzung bei $R_{\text{EXT}} = \infty$	$\leq 40 \text{ V}$
Strombegrenzung bei Überlast	$< 30 \text{ mA}$
Restwelligkeit des Ausgangsstromes	$\leq 1\% \text{ p.p.}$
Einstellzeit	$< 300 \text{ ms}$
Genauigkeit	
Bezugswert	Ausgangsnennwert
Grundgenauigkeit	Klasse 0,5

Arbeitstemperaturbereich	-10 °C bis +55 °C
Lagertemperaturbereich	-40 °C bis +70 °C
Hilfsenergie	
AC	24, 110, 115, 120, 230 oder 400 V, $\pm 15\%$, 50 / 60 Hz; PV ca. 3 VA
DC	24 V, -15 / +33% oder 24 V, -50 / +33% bei 2-Draht-Speisung und Aus- gang 4...20 mA; Pv ca. 1,5 W
Sicherheit	
Schutzklasse	II, (schutzisoliert, DIN EN 61010)
Berührungsschutz	IP 40, Gehäuse (Prüfdraht, EN 60529) IP 20, Anschlussklemmen (Prüffinger, EN 60529)
Verschmutzungsgrad	2
Überspannungskategorie	III
Nennisolationsspannung (gegen Erde)	300 V, Eingang 300 V, Hilfsenergie AC 50 V, Hilfsenergie 24 V DC 50 V, Ausgang
Prüfspannung	50 Hz, 1 min, EN 61010-1 3,7 kV, rms, Messeingang gegen alle anderen Kreise sowie Außenfläche und AC- Hilfsspannungseingang gegen Ausgang sowie Außenfläche 490 V, Messausgang gegen Außenfläche und DC-Hilfs- spannungseingang gegen Ausgang sowie Außenfläche
Gewicht	195 g



EMBSIN 201 IE

Messumformer für Wechselstrom



Merkmale / Nutzen

- Hilfsspannungsversorgung durch integriertes AC/DC-Weitbereichsnetzteil
- Echt-Effektivwertmessung, logarithmisches Messverfahren
- Mit zwei umschaltbaren Messbereichen: 0...1/5 A bzw. 0...1,2/6 A
- Messgröße: Sinusförmige oder verzerrte Wechselströme
- Messausgang: Unipolare und live-zero Ausgangsgrößen
- Aufbaugehäuse für 35 mm DIN-Hutschiene

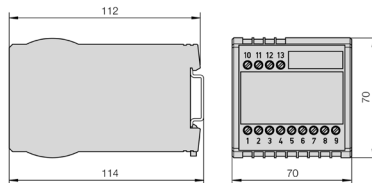

Anwendung

Messumformer zur Umwandlung von sinusförmigem oder verzerrtem Wechselstrom. Als Ausgangssignal steht ein eingprägtes Gleichstrom- oder aufgeprägtes Gleichspannungssignal zur Verfügung, das sich proportional zum RMS-Wert der Eingangsgröße verhält.

Der Messumformer erfüllt alle Anforderungen und Vorschriften hinsichtlich elektromagnetischer Verträglichkeit (EMV) und Sicherheit (IEC 1010 bzw. EN 61010). Die Messumformer sind zum ausschließlichen Einsatz in Innenräumen bestimmt.

Technische Kennwerte

Messeingang	
Nennfrequenz f_N	50 / 60 Hz
Eingangsnennstrom I_N	1 / 5 A oder 1,2 / 6 A, umklemmbar
Eigenverbrauch	≤ 1 VA
Überlastbarkeit	1,2 x I_N , dauernd 20 x I_N , 1 Sek.
Messausgang	
Stromausgang	
Eingprägter Gleichstrom	0...1 mA bis 0...20 mA bzw. live-zero 0,2...1 mA bis 4...20 mA
Max. Bürdenspannung	≤ 15 V
Max. Bürdenwiderstand	$R_{EXT} [k\Omega] \leq 15 \text{ V} / I_{AN} [mA]$
Strombegrenzung bei Überlast	ca. 1,5 x I_{AN}
Spannungsausgang (optional)	
Aufgeprägte Gleichspannung	0...1 V bis 0...10 V bzw. live-zero 0,2...1 V bis 2...10 V
Belastbarkeit	max. 2 mA
Min. Bürdenwiderstand	$R_{EXT} [k\Omega] \geq U_{AN} [V] / 2 \text{ mA}$
Spannungsbegrenzung bei $R_{EXT} = \infty$	≤ 25 V
Strombegrenzung bei Überlast	≤ 10 mA
Restwelligkeit des Ausgangsstromes	$\leq 0,5\%$ p.p. (Einstellzeit 300 ms) $\leq 2\%$ p.p. (Einstellzeit 50 ms)
Einstellzeit	50 ms oder 300 ms

Genauigkeit	
Bezugswert	Ausgangsendwert
Grundgenauigkeit	Klasse 0,5
Scheitelfaktor	$\sqrt{2}$
Anwärmzeit	≤ 5 min
Arbeitstemperaturbereich	-10 °C bis +55 °C
Lagertemperaturbereich	-40 °C bis +70 °C
Hilfsenergie	
Allstromnetzteil	DC oder AC (40...400 Hz);
AC/DC-Bereiche	24...60 V oder 85...230 V
AC-Netzteil	45...65 Hz
Leistungsaufnahme	$\leq 1,5$ W (3 VA)
Sicherheit	
Schutzklasse	II, (schutzisoliert, DIN EN 61010)
Berührungsschutz	IP 40, Gehäuse (Prüfdraht, EN 60529) IP 20, Anschlussklemmen (Prüffinger, EN 60529)
Verschmutzungsgrad	2
Überspannungskategorie	III
Nennisolationsspannung (gegen Erde)	300 V, Eingang 230 V, Hilfsenergie 40 V, Messausgang
Prüfspannung	50 Hz, 1 min, EN 61010-1 3,7 kV, Messeingang gegen alle anderen Kreise sowie Außenfläche 3,7 kV, Hilfsenergie gegen Ausgang sowie Außenfläche 490 V, Messausgang gegen Außenfläche
Gewicht	250 g

Bestelltablelle siehe Seite 356



EMBSIN 120 U

Messumformer für Wechselspannung

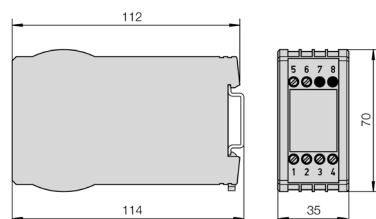

Merkmale / Nutzen

- Ohne Hilfsspannungsversorgung
- Aufbaugehäuse für 35 mm DIN-Hutschiene
- Messeingang: Sinusförmige Wechselspannung (0 ... 20 bis 0 ... 500 V), arithmetische Mittelwertmessung, effektivwertkalibriert
- Messausgang: Unipolare Ausgangsgrößen
- Messprinzip: Gleichrichter-Verfahren
- Geringer Verdrahtungsaufwand

Anwendung

Messumformer zur Umwandlung von sinusförmiger Wechselspannung. Als Ausgangssignal steht ein eingprägtes, dem Gleichricht-Mittelwert der Eingangsgröße proportionales Gleichstromsignal zur Verfügung, das zum Anzeigen, Registrieren, Überwachen und / oder Regeln dient.

Der Messumformer erfüllt alle Anforderungen und Vorschriften hinsichtlich elektromagnetischer Verträglichkeit (EMV) und Sicherheit (IEC 1010 bzw. EN 61010). Die Messumformer sind zum ausschließlichen Einsatz in Innenräumen bestimmt.

Technische Kennwerte

Messeingang	
Nennfrequenz f_N	50 / 60 Hz
Eingangsnennspannung U_N	0...20 V bis 0...500 V (Maximalwert Leiter-Leiter-Spannung!) max. Eingangsspannung gegen Erde 300 V
Eigenverbrauch	≤ 2 VA
Überlastbarkeit	$1,2 \times U_N$, dauernd $2 \times U_N$, 1 Sek.
Messausgang	
Stromausgang	
Eingprägter Gleichstrom	0...5 mA, 0...10 mA oder 0...20 mA
Max. Bürdenspannung	≤ 15 V
Max. Bürdenwiderstand	$R_{EXT} [k\Omega] \leq 15 V / I_{AN} [mA]$
Spannungsbegrenzung bei $R_{EXT} = \infty$	≤ 54 V
Strombegrenzung bei Überlast	$\leq 1,7 \times I_N$
Restwelligkeit des Ausgangsstromes	$\leq 1\%$ p.p.

Einstellzeit	≤ 300 ms
Genauigkeit	
Bezugswert	Ausgangsnennwert
Grundgenauigkeit	Klasse 0,5
Messbereich	$20...100\% U_N$
Temperatureinfluss (-10 ... +55 °C)	0,2% / 10 K
Arbeitstemperaturbereich	-10 °C bis +55 °C
Lagertemperaturbereich	-40 °C bis +70 °C
Sicherheit	
Schutzklasse	II, (schutzisoliert, DIN EN 61010)
Berührungsschutz	IP 40, Gehäuse (Prüfdraht, EN 60529) IP 20, Anschlussklemmen (Prüffinger, EN 60529)
Verschmutzungsgrad	2
Nennisolationsspannung	300 V, rms, Anschlusskategorie III 500 V, rms, Anschlusskategorie II
Gewicht	180 g

Bestelltabelle siehe Seite 357



EMBSIN 121 U

Messumformer für Wechselspannung



Merkmale / Nutzen

- Mit Hilfsspannungsversorgung
- Optional mit Messausgang 4 ... 20 mA und/oder 2-Drahttechnik
- Aufbaugehäuse für 35 mm DIN-Hutschiene
- Messeingang: Sinusförmige Wechselspannung, arithmetische Mittelwertmessung, effektivwertkalibriert
- Messausgang: Unipolare und live-zero Ausgangsgrößen
- Messprinzip: Gleichrichter-Verfahren
- AC oder DC Hilfsenergie

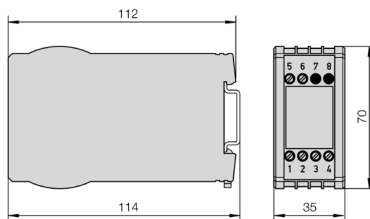

Anwendung

Messumformer zur Umwandlung von sinusförmiger Wechselspannung.

Als Ausgangssignal steht ein eingprägtes Gleichstrom- oder aufgeprägtes Gleichspannungssignal zur Verfügung, welches sich proportional zum Messwert der Eingangsgröße verhält.

Der Messumformer erfüllt alle Anforderungen und Vorschriften hinsichtlich elektromagnetischer Verträglichkeit (EMV) und Sicherheit (IEC 1010 bzw. EN 61010).

Die Messumformer sind zum ausschließlichen Einsatz in Innenräumen bestimmt.



Technische Kennwerte

Messeingang	
Nennfrequenz f_N	50 / 60 Hz
Eingangsnennspannung U_N	0...50 V bis 0...600 V (Leiter-Leiter-Spannung) U_N gegen Erde max. 300 V (Arbeitsspannung gemäß EN61010)
Eigenverbrauch	$< U_N \times 50 \mu\text{A}$ ($U_N \leq 150 \text{ V}$) $< U_N \times 20 \mu\text{A}$ ($150 \text{ V} < U_N \leq 400 \text{ V}$) $< U_N \times 5 \mu\text{A}$ ($400 \text{ V} < U_N \leq 600 \text{ V}$)
Überlastbarkeit	$1,2 \times U_N$, dauernd $2 \times U_N$, 1 Sek.
Messausgang	
Stromausgang	
Eingepprägter Gleichstrom	0...5 mA bis 0...20 mA bzw. live-zero 1...5 mA bis 4...20 mA
Max. Bürdenspannung	$\leq 15 \text{ V}$
Max. Bürdenwiderstand	$R_{\text{EXT}} [\text{k}\Omega] \leq 15 \text{ V} / I_{\text{AN}} [\text{mA}]$
Bei 2-Drahtanschluss	Normsignal 4...20 mA Außenwiderstand R_{ext} abhängig von de Hilfsenergie H (12...32 V DC) $R_{\text{EXT}} [\text{k}\Omega] \leq (\text{H}-12) \text{ V} / 20 \text{ mA}$
Strombegrenzung bei Überlast	$< 30 \text{ mA}$
Spannungsbegrenzung bei $R_{\text{EXT}} = \infty$	$\leq 40 \text{ V}$
Restwelligkeit des Ausgangsstromes	$\leq 1\% \text{ p.p.}$
Spannungsausgang (optional)	
Aufgeprägte Gleichspannung	0...5 V bis 0...10 V bzw. live-zero 1...5 V bis 2...10 V
Min. Bürdenwiderstand	$R_{\text{EXT}} [\text{k}\Omega] \leq U_{\text{AN}} [\text{V}] / 10 \text{ mA}$
Spannungsbegrenzung bei $R_{\text{EXT}} = \infty$	$\leq 40 \text{ V}$

Strombegrenzung bei Überlast	$\leq 30 \text{ mA}$
Restwelligkeit der Ausgangsspannung	$\leq 1\% \text{ p.p.}$
Einstellzeit	$< 300 \text{ ms}$
Genauigkeit	
Bezugswert	Ausgangsnennwert
Grundgenauigkeit	Klasse 0,5 ($U_N \leq 500 \text{ V}$) Klasse 1 ($U_N > 500 \text{ V}$)
Arbeitstemperaturbereich	$-10 \text{ }^\circ\text{C}$ bis $+55 \text{ }^\circ\text{C}$
Hilfsenergie	
Wechselspannung	24...400 V (siehe Auswahltablelle) $\pm 15\%$, 50 / 60 Hz Leistungsaufnahme $P \leq 3 \text{ VA}$
Gleichspannung	24 V, $-15 / +33\%$ 24 V, $-50 / +33\%$ bei 2-Draht-Speisung und Messausgang 4...20 mA Leistungsaufnahme $P \leq 1,5 \text{ W}$
Weitbereichversorgung	24...60 V AC/DC DC $-15 / +33\%$ Leistungsaufnahme $P \leq 1,5 \text{ W}$ AC $\pm 15\%$ Leistungsaufnahme $P \leq 3 \text{ VA}$
Sicherheit	
Schutzklasse	II, (schutzisoliert, DIN EN 61010)
Berührungsschutz	IP 40, Gehäuse (Prüfdraht, EN 60529) IP 20, Anschlussklemmen (Prüffinger, EN 60529)
Verschmutzungsgrad	2
Überspannungskategorie	III
Nennisolationsspannung (gegen Erde)	300 V, Eingang 300 V, Hilfsenergie AC 50 V, Hilfsenergie 24 V DC 50 V, Ausgang
Gewicht	280 g

Bestelltablelle siehe Seite 355

SWMU

NMC

NMC-AD

NMC-KSX

EMBSIN

MT

Bestelllisten



EMBSIN 221 UE

Messumformer für Wechselspannung



Merkmale / Nutzen

- Hilfsspannungsversorgung durch integriertes AC/DC-Weitbereichsnetzteil
- Echt-Effektivwertmessung, logarithmisches Messverfahren
- Messgröße: Sinusförmige oder verzerrte Wechselspannung
- Messbereiche: 0...20 V bis 0...690 V
- Messausgang: Unipolare und live-zero Ausgangsgrößen
- Aufbaugehäuse für 35 mm DIN-Hutschiene

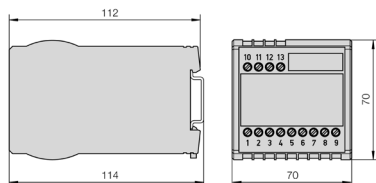

Anwendung

Messumformer zur Umwandlung von sinusförmiger oder verzerrter Wechselspannung. Als Ausgangssignal steht ein eingprägtes Gleichstrom- oder aufgeprägtes Gleichspannungssignal zur Verfügung, welches sich proportional zum RMS-Wert der Eingangsgröße verhält.

Der Messumformer erfüllt alle Anforderungen und Vorschriften hinsichtlich elektromagnetischer Verträglichkeit (EMV) und Sicherheit (IEC 1010 bzw. EN 61010). Die Messumformer sind zum ausschließlichen Einsatz in Innenräumen bestimmt.

Technische Kennwerte

Messeingang

Nennfrequenz f_N	50 / 60 Hz oder 400 Hz
Eingangsnennspannung U_N	0...20 V bis 0...690 V max. Eingangsspannung gegen Erde 400 V!
Eigenverbrauch	≤ 1 VA bei U_N
Überlastbarkeit	$1,2 \times U_N$, dauernd $2 \times U_N$, 1 Sek.

Messausgang

Stromausgang	
Eingprägter Gleichstrom	0...1 mA bis 0...20 mA bzw. live-zero 0,2...1 mA bis 4...20 mA
Max. Bürdenspannung	≤ 15 V
Max. Bürdenwiderstand	$R_{EXT} [k\Omega] \leq 15 \text{ V} / I_{AN} [mA]$
Strombegrenzung bei Überlast	$\leq 1,5 \times I_{AN}$
Spannungsbegrenzung bei $R_{EXT} = \infty$	≤ 25 V
Restwelligkeit des Ausgangsstromes	$\leq 0,5\%$ p.p. (Einstellzeit 300 ms) $\leq 2\%$ p.p. (Einstellzeit 50 ms)
Spannungsausgang	
Aufgeprägte Gleichspannung	0...1 V bis 0...10 V bzw. live-zero 0,2...1 V bis 2...10 V
Belastbarkeit	max. 2 mA
Min. Bürdenwiderstand	$R_{EXT} [k\Omega] \geq U_{AN} [V] / 2 \text{ mA}$

Spannungsbegrenzung bei $R_{EXT} = \infty$	< 25 V
Einstellzeit	50 ms oder 300 ms
Genauigkeit	
Bezugswert	Ausgangsnennwert
Grundgenauigkeit	Klasse 0,5
Anwärmzeit	≤ 5 min
Arbeitstemperaturbereich	-10 °C bis +55 °C
Hilfsenergie	
Allstromnetzteil	DC oder AC (40...400 Hz);
AC/DC-Bereiche	24...60 V oder 85...230 V DC -15% / +33% AC $\pm 15\%$
Leistungsaufnahme	$\leq 1,5$ W (3 VA)
Sicherheit	
Schutzklasse	II, (schutzisoliert, DIN EN 61010)
Berührungsschutz	IP 40, Gehäuse (Prüfdraht, EN 60529) IP 20, Anschlussklemmen (Prüffinger, EN 60529)
Verschmutzungsgrad	2
Überspannungskategorie	III
Nennisolationsspannung (gegen Erde)	400 V, Eingang 230 V, Hilfsenergie 40 V, Messausgang
Gewicht	250 g

Bestelltabelle siehe Seite 356



EMBSIN 241 F

Messumformer für Frequenz

Merkmale / Nutzen

- Hilfsspannungsversorgung durch integriertes AC/DC-Weitbereichsnetzteil
- Aufbaueinheit für 35 mm DIN-Hutschiene
- Messeingang: Sinusförmige, rechteckförmige oder verzerrte Eingangsspannung (10 bis 690 V, 10 Hz bis $\leq 1,5$ kHz) mit dominierender Grundwelle
- Messausgang: Unipolare, bipolare oder live-zero Ausgangsgrößen
- Messprinzip: Digitale Periodendauer-Messung

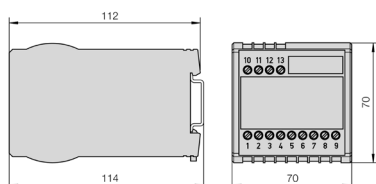

Anwendung

Messumformer zur Frequenzmessung. Als Ausgangssignal steht ein eingepreßtes Gleichstrom- oder aufgeprägtes Gleichspannungssignal zur Verfügung, welches sich proportional zur Frequenz der Eingangsgröße verhält.

Der Messumformer erfüllt alle Anforderungen und Vorschriften hinsichtlich elektromagnetischer Verträglichkeit (EMV) und Sicherheit (IEC 1010 bzw. EN 61010). Die Messumformer sind zum ausschließlichen Einsatz in Innenräumen bestimmt.

Technische Kennwerte

Messeingang	
Messbereich	wählbar zwischen $f_u = 10$ Hz und $f_o = 1,5$ kHz
Minimale Spanne	$\Delta f = f_u / (f_o - f_u) < 50$
Eingangsnennspannung U_N	10...230 V oder 230...690 V (max. 230 V bei Versorgungs- spannung ab Messeingang)
Eigenverbrauch	$\leq U_N \times 1,5$ mA
Überlastbarkeit	1,2 x U_N , dauernd 2 x U_N , 1 Sek. max. 264 V bei Hilfsspannungs- versorgung ab Messeingang
Kurvenform	beliebig, nur Grundwelle wird berücksichtigt
Messausgang	
Einstellzeit der Ausgangsgrößen	4 Perioden der Grundwelle (Standard) 2, 8, 16 Perioden der Grundwelle (optional)
Stromausgang	
unipolar	0...1 mA bis 0...20 mA bzw. live-zero 1...5 mA bis 4...20 mA
bipolar	± 1 mA bis ± 20 mA
Max. Bürdenspannung	$\leq +15$ V bzw. ≥ -12 V
Strombegrenzung bei Überlast	$1,3 \times I_{AN}$
Restwelligkeit des Ausgangsstromes	$\leq 0,5\%$ p.p.
Spannungsausgang (optional)	
unipolar	0...1 V bis 0...10 V bzw. live-zero 0,2...1 V bis 2...10 V
bipolar	± 1 V bis ± 10 V
Belastbarkeit	≤ 4 mA

Spannungsbegrenzung bei $R_{EXT} = \infty$	≤ 25 V
Strombegrenzung bei Überlast	≤ 30 mA
Genauigkeit	
Bezugswert	Ausgangsspanne
Grundgenauigkeit	Klasse 0,2
Arbeitstemperaturbereich	-10 °C bis +55 °C
Lagertemperaturbereich	-40 °C bis +70 °C
Hilfsenergie	
Allstromnetzteil	DC oder AC (40...400 Hz); DC: -15% / +33% 2 W AC: $\pm 15\%$ 4 VA
AC/DC-Bereiche oder AC-Hilfsenergie ab Spannungsmesseingang	24...60 V oder 85...230 V 40...300 V DC und 40...276 V AC (40 Hz $\leq f \leq 400$ Hz) $\pm 15\%$
Sicherheit	
Schutzklasse	II, (schutzisoliert, DIN EN 61010)
Berührungsschutz	IP 40, Gehäuse (Prüfdraht, EN 60529) IP 20, Anschlussklemmen (Prüffinger, EN 60529)
Verschmutzungsgrad	2
Überspannungskategorie	III
Nennisolationsspannung (gegen Erde)	230 V bzw. 400 V Eingang 230 V, Hilfsenergie 40 V, Messausgang
Prüfspannung	50 Hz, 1 min, EN 61010-1 3,7 kV bzw. 5,55 kV, Mess- eingang gegen alle anderen Kreise sowie Außenfläche 3,7 kV, Hilfsenergie gegen Ausgang sowie Außenfläche 490 V, Messausgang gegen Außenfläche
Gewicht	300 g

Bestelltabelle siehe Seite 358



EMBSIN 241 FD

Messumformer für Frequenz-Differenz



Merkmale / Nutzen

- Hilfsspannungsversorgung durch integriertes AC/DC-Weitbereichsnetzteil
- Messgröße: Frequenzdifferenz
- Messeingänge: Sinusförmige, rechteckförmige oder verzerrte Wechselspannungen mit dominierendem Grundwellenanteil
- Eingangsspannungen 10...690 V (Spannung zwischen Generator und Sammelschiene)
- Messprinzip: Digitale Periodendauer-Messung
- Aufbaugeschwindigkeit für 35 mm DIN-Hutschiene

Anwendung

Messumformer zur Erfassung der Frequenz-Differenz zwischen zwei zu synchronisierenden Netzen. Als Ausgangssignal steht ein eingepprägtes Gleichstrom- oder ein aufgeprägtes Gleichspannungssignal zur Verfügung, das sich proportional zum Messwert verhält.

Der Messumformer erfüllt alle Anforderungen und Vorschriften hinsichtlich elektromagnetischer Verträglichkeit (EMV) und Sicherheit (IEC 1010 bzw. EN 61010). Die Messumformer sind zum ausschließlichen Einsatz in Innenräumen bestimmt.

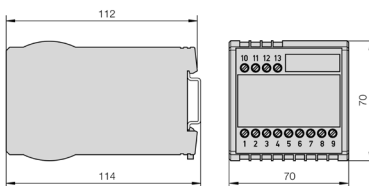



Technische Kennwerte

Messeingang

Messbereich	$\Delta f = \pm(0,01...0,80) \times f_s$ $10 \text{ Hz} \leq f_s, f_G \leq 1,5 \text{ kHz}$ f_s ... Sammelschienenfrequenz f_G ... Generatorfrequenz
Eingangsnennspannung U_N	10...230 V oder 230...690 V Spannung zwischen Sammelschiene und Generator! max. 230 V bei Hilfsenergie ab Messeingang!
Eigenverbrauch	$< U_N \times 1,5 \text{ mA}$ pro Messeingang
Überlastbarkeit	$1,2 \times U_N$, dauernd $2 \times U_N$, 1 Sek. max. 264 V bei Hilfsspannungsversorgung ab Messeingang
Kurvenform	beliebig, nur Grundwelle wird berücksichtigt

Messausgang

Stromausgang	
unipolar	0...1 mA bis 0...20 mA bzw. live-zero 1...5 mA bis 4...20 mA
bipolar	$\pm 1 \text{ mA}$ bis $\pm 20 \text{ mA}$
Max. Bürdenspannung	$\leq +15 \text{ V}$ bzw. $\geq -12 \text{ V}$
Strombegrenzung bei Überlast	$\leq 1,3 \times I_{AN}$
Spannungsbegrenzung bei Überlast	$\leq 25 \text{ V}$
Restwelligkeit des Ausgangsstromes	$< 0,5\%$ p.p.
Spannungsausgang	
unipolar	0...1 V bis 0...10 V bzw. live-zero 0,2...1 V bis 2...10 V
bipolar	$\pm 1 \text{ V}$ bis $\pm 10 \text{ V}$
Belastbarkeit	$\leq 4 \text{ mA}$
Spannungsbegrenzung bei $R_{EXT} = \infty$	$\leq 25 \text{ V}$
Strombegrenzung bei Überlast	$\leq 30 \text{ mA}$

Genauigkeit

Bezugswert	Ausgangsspanne
Grundgenauigkeit	Klasse 0,2
Einstellzeit	4 Perioden der Messfrequenz Optional 2, 8 oder 16 Perioden der Messfrequenz
Arbeitstemperaturbereich	-10 °C bis +55 °C
Lagertemperaturbereich	-40 °C bis +70 °C

Hilfsenergie

Allstromnetzteil	DC oder AC (40...400 Hz);
AC/DC-Bereiche	24...60 V oder 85...230 V
Toleranzangabe	DC: -15...+33% AC: $\pm 15\%$
Optional	
Hilfsenergie ab Spannungsmesseingang (optional)	AC 24...60 V oder 85...230 V (40...400 Hz)
Leistungsaufnahme	ca. 2 W (4 VA)

Sicherheit

Schutzklasse	II, (schutzisoliert, DIN EN 61010)
Berührungsschutz	IP 40, Gehäuse (Prüfdraht, EN 60529) IP 20, Anschlussklemmen (Prüffinger, EN 60529)
Verschmutzungsgrad	2
Überspannungskategorie	III
Nennisolationsspannung (gegen Erde)	230 V bzw. 400 V, Eingänge 230 V, Hilfsenergie 40 V, Messausgang
Prüfspannung	50 Hz, 1 min, EN 61010-1 3,7 kV bzw. 5,55 kV, Messeingang gegen alle anderen Kreise sowie Außenfläche 3,7 kV, Hilfsenergie gegen Ausgang sowie Außenfläche 490 V, Messausgang gegen Außenfläche
Gewicht	270 g

SWMU

NMC

NMC-AD

NMC-KSX

EMBSIN

MT

Bestelllisten

Bestelltabelle siehe Seite 358



EMBSIN 271 G

Messumformer für Phasenwinkel



Merkmale / Nutzen

- Hilfsspannungsversorgung durch integriertes AC/DC-Weitbereichsnetzteil
- Messgröße: Phasenwinkel
- Messeingänge: Sinusförmige, rechteckförmige oder verzerrte Wechselspannungen mit dominierendem Grundwellenanteil
- Eingangsspannungen 10...690 V (Spannung zwischen Generator und Sammelschiene)
- Eingangsnennstrom 0,5...6 A
- Eingangsnennfrequenz 16...400 Hz
- Messbereichsgrenzen: Min. Spanne 20 °el., max. Spanne 360 °el.
- Messprinzip: Erfassung des Abstandes der Nulldurchgänge
- Aufbaueinheit für 35 mm DIN-Hutschiene

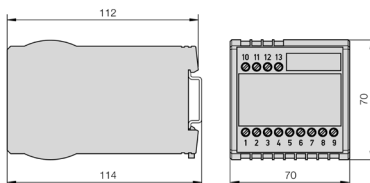

Anwendung

Messumformer zur Erfassung des Phasenwinkels zwischen Strom und Spannung im Einphasen- oder gleichbelasteten Dreiphasennetz. Als Ausgangssignal steht ein eingprägtes Gleichstrom- oder aufgeprägtes Gleichspannungssignal zur Verfügung, welches sich proportional zum Phasenwinkel bzw. Leistungsfaktor zwischen den Messgrößen Strom und Spannung verhält.

Der Messumformer erfüllt alle Anforderungen und Vorschriften hinsichtlich elektromagnetischer Verträglichkeit (EMV) und Sicherheit (IEC 1010 bzw. EN 61010). Die Messumformer sind zum ausschließlichen Einsatz in Innenräumen bestimmt.



Technische Kennwerte

Messeingang	
Eingangsnennspannung U_N	10...690 V (max. 230 V bei Hilfsenergie ab Messeingang)
Eingangsnennfrequenz f_N	16 2/3 ... 400 Hz
Eingangsnennstrom I_N	$\geq 0,5...6$ A
Ansprechempfindlichkeit	
Eingangsspannung	$10...120\% U_N$
Eingangsstrom	$< 1\% I_N$
Eigenverbrauch	$< 0,1$ VA Strompfad $\leq U_N \times 1,5$ mA Spannungspfad
Überlastbarkeit	
Stromeingang	$1,2 \times I_N$, dauernd $20 \times I_N$, 1 Sek.
Spannungseingang	$1,2 \times U_N$, dauernd $2 \times U_N$, 1 Sek.
Messbereiche	-175 °el ... $+175$ °el
Messausgang	
Stromausgang	
Eingeprägter Gleichstrom	
unipolar	$0...1$ mA bis $0...20$ mA bzw. live-zero $1...5$ mA bis $4...20$ mA
bipolar	± 1 mA bis ± 20 mA
Max. Bürdenspannung	$\leq +15$ V bzw. ≥ -12 V
Strombegrenzung bei Überlast	$\leq 1,3 \times I_{AN}$
Spannungsbegrenzung bei $R_{EXT} = \infty$	≤ 25 V
Restwelligkeit des Ausgangsstromes	$< 0,5\%$ p.p.
Spannungsausgang (optional)	
Aufgeprägte Gleichspannung	
unipolar	$0...1$ V bis $0...10$ V bzw. live-zero $0,2...1$ V bis $2...10$ V

bipolar	± 1 V bis ± 10 V
Belastbarkeit	max. 4 mA
Strombegrenzung bei Überlast	≤ 30 mA
Genauigkeit	
Bezugswert	$\Delta\varphi = 90^\circ$
Grundgenauigkeit	Klasse 0,5
Einstellzeit	4 Perioden der Nennfrequenz (Standard) Optional 2, 8 oder 16 Perioden der Nennfrequenz
Arbeitstemperaturbereich	-10 °C bis $+55$ °C
Lagertemperaturbereich	-40 °C bis $+70$ °C
Hilfsenergie	
Allstromnetzteil	DC oder AC (40...400 Hz);
AC/DC-Bereiche	24...60 V oder 85...230 V
Hilfsenergie ab Spannungs- messeingang (optional)	24...60 V AC oder 85...230 V AC
Toleranzangabe	DC: $-15...+33\%$ AC: $\pm 15\%$
Leistungsaufnahme	≤ 2 W (4 VA)
Sicherheit	
Schutzklasse	II, (schutzisoliert, DIN EN 61010)
Berührungsschutz	IP 40, Gehäuse (Prüfdraht, EN 60529) IP 20, Anschlussklemmen (Prüffinger, EN 60529)
Verschmutzungsgrad	2
Überspannungskategorie	III
Nennisolationsspannung (gegen Erde)	230 V bzw. 400 V, Eingänge 230 V, Hilfsenergie 40 V, Messausgang
Gewicht	260 g

SWMU

NMC

NMC-AD

NMC-KSX

EMBSIN

MT

Bestelllisten

Bestelltabelle siehe Seite 359



EMBSIN 271 GD

Messumformer für Phasenwinkel-Differenz

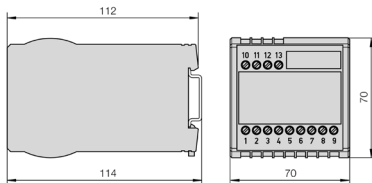

Merkmale / Nutzen

- Messgröße: Phasenwinkeldifferenz
- Messeingänge: Sinusförmige, rechteckförmige oder verzerrte Wechselspannungen mit dominierender Grundwelle
- Eingangsnennspannungen 10...690 V (Spannung zwischen Generator und Sammelschiene)
- Eingangsnennfrequenz 50 Hz oder 60 Hz, optional: > 10 Hz ... 1500 Hz
- Messbereichsgrenzen: $\pm 10^\circ$ el. bis $< \pm 180^\circ$ el.
- Messprinzip: Erfassung des Abstandes der Nulldurchgänge
- Hilfsspannungsversorgung über integrierte AC/DC-Allstromnetzteile
- Aufbauehäuse für 35 mm DIN-Hutschiene

Anwendung

Messumformer zur Erfassung der Phasenwinkeldifferenz zwischen zwei zu synchronisierenden Netzen. Als Ausgangssignal steht ein eingepprägtes Gleichstrom- oder aufgeprägtes Gleichspannungssignal zur Verfügung, welches sich proportional zum Messwert verhält.

Der Messumformer erfüllt alle Anforderungen und Vorschriften hinsichtlich elektromagnetischer Verträglichkeit (EMV) und Sicherheit (IEC 1010 bzw. EN 61010).

Technische Kennwerte

Messeingang	
Eingangsnennspannung U_N	10...690 V (max. 230 V bei Hilfsenergie ab Messeingang)
Eingangsnennfrequenz f_N	50 Hz oder 60 Hz
Ansprechempfindlichkeit	10...120% U_N
Eigenverbrauch	$\leq U_N \times 1,5$ mA Spannungspfad
Überlastbarkeit	1,2 x U_N , dauernd 2 x U_N , 1 Sek.
Messbereiche	-175° ... +175°
Messausgang	
Stromausgang	
Eingepprägter Gleichstrom	
unipolar	0...1 mA bis 0...20 mA bzw. live-zero 1...5 mA bis 4...20 mA
bipolar	± 1 mA bis ± 20 mA
Max. Bürdenspannung	$\leq +15$ V bzw. ≥ -12 V
Strombegrenzung bei Überlast	$\leq 1,3 \times I_{AN}$
Spannungsbegrenzung bei $R_{EXT} = \infty$	≤ 25 V
Restwelligkeit des Ausgangsstromes	< 0,5% p.p.
Spannungsausgang (optional)	
Aufgeprägte Gleichspannung	
unipolar	0...1 V bis 0...10 V bzw. live-zero 0,2...1 V bis 2...10 V
bipolar	± 1 V bis ± 10 V

Belastbarkeit	≤ 4 mA
Strombegrenzung bei Überlast	≤ 30 mA
Genauigkeit	
Bezugswert	$\Delta\varphi = 90^\circ$
Grundgenauigkeit	Klasse 0,5
Einstellzeit	4 Perioden der Nennfrequenz (Standard) Optional 2, 8 oder 16 Perioden der Nennfrequenz
Arbeitstemperaturbereich	-10 °C bis +55 °C
Lagertemperaturbereich	-40 °C bis +70 °C
Hilfsenergie	
Allstromnetzteil	DC oder AC (40...400 Hz);
AC/DC-Bereiche	24...60 V oder 85...230 V
Hilfsenergie ab Spannungsmesseingang (optional)	24...60 V AC oder 85...230 V AC
Toleranzangabe	DC: -15...+33% AC: ± 15 %
Leistungsaufnahme	≤ 2 W (4 VA)
Sicherheit	
Schutzklasse	II, (schutzisoliert, DIN EN 61010)
Berührungsschutz	IP 40, Gehäuse IP 20, (Prüfdraht, EN 60529) IP 20, Anschlussklemmen (Prüffinger, EN 60529)
Verschmutzungsgrad	2
Überspannungskategorie	III
Nennisolationsspannung (gegen Erde)	230 V bzw. 400 V, Eingänge 230 V, Hilfsenergie 40 V, Messausgang
Gewicht	270 g

Bestelltabelle siehe Seite 361





EMBSIN 281 G

Messumformer für Leistungsfaktor



Merkmale / Nutzen

- Messgröße: Leistungsfaktor
- Messeingänge: Sinusförmige, rechteckförmige oder verzerrte Wechselspannungen mit dominierendem Grundwellenanteil
- Eingangsspannungen 10...690 V (in Dreiphasensystemen verkettete Spannung!)
- Eingangsnennstrom 0,5...6 A
- Eingangsnennfrequenz 16...400 Hz
- Messbereichsgrenzen: 0,5...cap...1 ... ind...0,5
- Messprinzip: Erfassung des Abstandes der Nulldurchgänge
- Hilfsspannungsversorgung über integrierte AC/DC-Allstromnetzteile
- Aufbaugehäuse für 35 mm DIN-Hutschiene

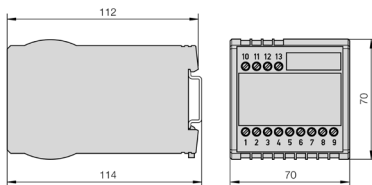

Anwendung

Messumformer zur Bestimmung des Leistungsfaktors zwischen Strom und Spannung eines Einphasennetzes oder eines symmetrisch belasteten Dreiphasennetzes. Als Ausgangssignal steht ein eingepprägtes Gleichstrom- oder aufgeprägtes Gleichspannungssignal zur Verfügung, welches sich direkt proportional zum Leistungsfaktor der Eingangsgrößen verhält.

Der Messumformer erfüllt alle Anforderungen und Vorschriften hinsichtlich elektromagnetischer Verträglichkeit (EMV) und Sicherheit (IEC 1010 bzw. EN 61010).



Technische Kennwerte

Messeingang

Eingangsnennspannung U_N	10...690 V (max. 230 V bei Hilfsenergie ab Messeingang)
Eingangsnennfrequenz f_N	16 2/3 ... 400 Hz
Eingangsnennstrom I_N	$\geq 0,5...6$ A
Ansprechempfindlichkeit	$10...120\%$ U_N
Eingangsstrom	$< 1\%$ I_N
Eigenverbrauch	$< 0,1$ VA Strompfad $\leq U_N \times 1,5$ mA Spannungspfad
Überlastbarkeit	
Stromeingang	$1,2 \times I_N$, dauernd $20 \times I_N$, 1 Sek.
Spannungseingang	$1,2 \times U_N$, dauernd $2 \times U_N$, 1 Sek.
Messbereiche	0,5...cap...1 ... ind...0,5
Messausgang	
Stromausgang	
Eingeprägter Gleichstrom	
unipolar	0...1 mA bis 0...20 mA bzw. live-zero 1...5 mA bis 4...20 mA
bipolar	± 1 mA bis ± 20 mA
Max. Bürdenspannung	$\leq +15$ V bzw. ≥ -12 V
Strombegrenzung bei Überlast	$\leq 1,3 \times I_{AN}$
Spannungsbegrenzung bei $R_{EXT} = \infty$	≤ 25 V
Restwelligkeit des Ausgangsstromes	$< 0,5\%$ p.p.
Spannungsausgang (optional)	
Aufgeprägte Gleichspannung	
unipolar	0...1 V bis 0...10 V bzw. live-zero 0,2...1 V bis 2...10 V

bipolar	± 1 V bis ± 10 V
Belastbarkeit	max. 4 mA
Strombegrenzung bei Überlast	≤ 30 mA
Genauigkeit	
Bezugswert	$\Delta\varphi = 90^\circ$
Grundgenauigkeit	Klasse 0,5
Einstellzeit	4 Perioden der Nennfrequenz (Standard) Optional 2, 8 oder 16 Perioden der Nennfrequenz
Arbeitstemperaturbereich	-10°C bis $+55^\circ\text{C}$
Hilfsenergie	
Allstromnetzteil	DC oder AC (40...400 Hz)
AC/DC-Bereiche	24...60 V oder 85...230 V
Hilfsenergie ab Spannungs- messeingang (optional)	24...60 V AC oder 85...230 V AC
Toleranzangabe	DC: $-15...+33\%$ AC: $\pm 15\%$
Leistungsaufnahme	≤ 2 W (4 VA)
Sicherheit	
Schutzklasse	II, (schutzisoliert, DIN EN 61010)
Berührungsschutz	IP 40, Gehäuse (Prüfdraht, EN 60529) IP 20, Anschlussklemmen (Prüffinger, EN 60529)
Verschmutzungsgrad	2
Überspannungskategorie	III
Nennisolationsspannung (gegen Erde)	230 V bzw. 400 V, Eingänge 230 V, Hilfsenergie 40 V, Messausgang
Gewicht	260 g

SWMU

NMC

NMC-AD

NMC-KSX

EMBSIN

MT

Bestelllisten

Bestelltabelle siehe Seite 359



EMBSIN 351 P

Messumformer für Wirkleistung



Merkmale / Nutzen

- Messgröße: Wirkleistung
- Messeingänge: Sinusförmige Eingangsnennströme und sinusförmige Eingangsnennspannungen
- Eingangsspannungen 100...690 V (in Dreiphasensystemen verkettete Spannung!)
- Eingangsstrom 1...6 A
- Eingangsnennfrequenz 50 Hz oder 60 Hz
- Messprinzip: Impulsbreitenmodulation (Time-Division-Multiplikation [TDM-Verfahren])
- Hilfsspannungsversorgung über integrierte AC/DC-Allstromnetzteile
- Aufbauehäuse für 35 mm DIN-Hutschiene

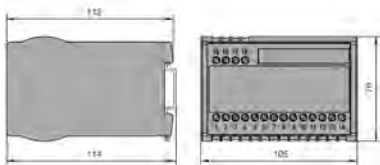

Anwendung

Messumformer zur Erfassung der Wirkleistung eines Einphasen-Wechselstrom- oder Drehstromnetzes gleicher oder beliebiger Phasenbelastung. Als Ausgangssignal steht ein eingprägtes Gleichstrom- oder aufgeprägtes Gleichspannungssignal zur Verfügung, welches sich direkt proportional zur Wirkleistung des Primärnetzes verhält.

Der Messumformer erfüllt alle Anforderungen und Vorschriften hinsichtlich elektromagnetischer Verträglichkeit (EMV) und Sicherheit (IEC 1010 bzw. EN 61010).



Technische Kennwerte

Messeingang

Eingangsnennspannung U_N	100...690 V (Leiter-Leiter-Spannung) (max. 230 V bei Hilfsenergie ab Messeingang)
Eingangsnennfrequenz f_N	50 Hz oder 60 Hz
Eingangsnennstrom I_N	1...6 A
Kalibrierbereich	$0,75...1,3 \times P_{NENN}$ $P_{NENN} = \sqrt{3} \times U_N \times I_N$
Eigenverbrauch	$< I_N^2 \times 0,01 \Omega$ pro Strompfad $\leq U_N^2 / 400 \text{ k}\Omega$ pro Spannungspfad
Überlastbarkeit	
Stromeingang	$1,2 \times I_{N'}$ dauernd $20 \times I_{N'}$ 1 Sek.
Spannungseingang	$1,2 \times U_{N'}$ dauernd $2 \times U_{N'}$ 1 Sek. (max. 264 V bei Hilfsenergie ab Spannungs-Messeingang)

Messausgang

Stromausgang	
Eingeprägter Gleichstrom	
unipolar	0...1 mA bis 0...20 mA bzw. live-zero 1...5 mA bis 4...20 mA
bipolar	± 1 mA bis ± 20 mA
Max. Bürdenspannung	± 15 V
Strombegrenzung bei Überlast	$\leq 1,3 \times I_{AN}$
Spannungsbegrenzung bei $R_{EXT} = \infty$	≤ 40 V
Restwelligkeit des Ausgangsstromes	$< 1\%$ p.p.
Spannungsausgang (optional)	

Aufgeprägte Gleichspannung

unipolar	0...1 V bis 0...10 V bzw. live-zero 0,2...1 V bis 2...10 V
bipolar	± 1 V bis ± 10 V
Belastbarkeit	max. 4 mA
Strombegrenzung bei Überlast	≤ 30 mA
Genauigkeit	
Bezugswert	Ausgangsendwert
Grundgenauigkeit	Klasse 0,5
Einstellzeit	< 300 ms
Arbeitstemperaturbereich	-10 °C bis +55 °C

Hilfsenergie

Allstromnetzteil	DC oder AC (40...400 Hz)
AC/DC-Bereiche	24...60 V oder 85...230 V
Hilfsenergie ab Spannungsmesseingang (optional)	24...60 V AC oder 85...230 V AC
Toleranzangabe	DC: -15...+33 % AC: $\pm 15\%$
Leistungsaufnahme	ca. 2,5 W (4,5 VA)

Sicherheit

Schutzklasse	II (schutzisoliert, DIN EN 61010)
Berührungsschutz	IP 40, Gehäuse (Prüfdraht, EN 60529) IP 20, Anschlussklemmen (Prüffinger, EN 60529)
Verschmutzungsgrad	2
Überspannungskategorie	III
Nennisolationsspannung (gegen Erde)	230 V bzw. 400 V, Eingänge 230 V, Hilfsenergie 40 V, Messausgang
Gewicht	330 g

SWMU

NMC

NMC-AD

NMC-KSX

EMBSIN

MT

Bestelllisten

Bestelltabelle siehe Seite 362



EMBSIN 361 Q

Messumformer für Blindleistung



Merkmale / Nutzen

- Messgröße: Blindleistung
- Messeingänge: Sinusförmige Eingangsnennströme und sinusförmige Eingangsnennspannungen
- Eingangsspannungen 100...690 V (in Dreiphasensystemen verkettete Spannung!)
- Eingangsstrom 1...6 A
- Eingangsnennfrequenz 50 Hz oder 60 Hz
- Messprinzip: Impulsbreitenmodulation (Time-Division-Multiplikation [TDM-Verfahren])
- Hilfsspannungsversorgung über integrierte AC/DC-Allstromnetzteile
- Aufbaugehäuse für 35 mm DIN-Hutschiene

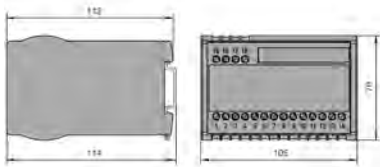

Anwendung

Messumformer zur Erfassung der Blindleistung eines Einphasen-Wechselstrom- oder Drehstromnetzes gleicher, oder beliebiger Phasenbelastung. Als Ausgangssignal steht ein eingepprägtes Gleichstrom- oder aufgeprägtes Gleichspannungssignal zur Verfügung, welches sich direkt proportional zur Blindleistung des Primärnetzes verhält.

Der Messumformer erfüllt alle Anforderungen und Vorschriften hinsichtlich elektromagnetischer Verträglichkeit (EMV) und Sicherheit (IEC 1010 bzw. EN 61010).



Technische Kennwerte

Messeingang

Eingangsnennspannung U_N	100...690 V (Leiter-Leiter-Spannung) (max. 230 V bei Hilfsenergie ab Messeingang)
Eingangsnennfrequenz f_N	50 Hz oder 60 Hz
Eingangsnennstrom I_N	1...6 A
Kalibrierbereich	0,5...1,0 x P_{NENN} $P_{NENN} = \sqrt{3} \times U_N \times I_N$
Eigenverbrauch	$< I_N^2 \times 0,01 \Omega$ pro Strompfad $\leq U_N^2 / 400 \text{ k}\Omega$ pro Spannungspfad
Überlastbarkeit	
Stromeingang	$1,2 \times I_{N'}$ dauernd $20 \times I_{N'}$ 1 Sek.
Spannungseingang	$1,2 \times U_{N'}$ dauernd $2 \times U_{N'}$ 1 Sek. (max. 264 V bei Hilfsenergie ab Spannungs-Messeingang)

Messausgang

Stromausgang	
Eingeprägter Gleichstrom	
unipolar	0...1 mA bis 0...20 mA bzw. live-zero 1...5 mA bis 4...20 mA
bipolar	± 1 mA bis ± 20 mA
Max. Bürdenspannung	± 15 V
Strombegrenzung bei Überlast	$\leq 1,3 \times I_{AN}$
Spannungsbegrenzung bei $R_{EXT} = \infty$	≤ 40 V
Restwelligkeit des Ausgangsstromes	$< 1\%$ p.p.

Spannungsausgang
(optional)

Aufgeprägte Gleichspannung	
unipolar	0...1 V bis 0...10 V bzw. live-zero 0,2...1 V bis 2...10 V
bipolar	± 1 V bis ± 10 V
Belastbarkeit	max. 4 mA
Strombegrenzung bei Überlast	≤ 30 mA
Genauigkeit	
Bezugswert	Ausgangsendwert
Grundgenauigkeit	Klasse 0,5
Einstellzeit	< 300 ms
Arbeitstemperaturbereich	-10 °C bis +55 °C
Hilfsenergie	
Allstromnetzteil	DC oder AC (40...400 Hz)
AC/DC-Bereiche	24...60 V oder 85...230 V
Hilfsenergie ab Spannungsmesseingang (optional)	24...60 V AC oder 85...230 V AC
Toleranzangabe	DC: -15...+33 % AC: $\pm 15\%$
Leistungsaufnahme	ca. 2,5 W (4,5 VA)
Sicherheit	
Schutzklasse	II, (schutzisoliert, DIN EN 61010)
Berührungsschutz	IP 40, Gehäuse (Prüfdraht, EN 60529) IP 20, Anschlussklemmen (Prüffinger, EN 60529)
Verschmutzungsgrad	2
Überspannungskategorie	III
Nennisolationsspannung (gegen Erde)	230 V bzw. 400 V, Eingänge 230 V, Hilfsenergie 40 V, Messausgang
Gewicht	330 g

Bestelltabelle siehe Seite 362

SWMU

NMC

NMC-AD

NMC-KSX

EMBSIN

MT

Bestelllisten

EMBSIN 301

Programmierbarer Messumformer für Wechselstrom



Merkmale / Nutzen

- Hilfsspannungsversorgung 230 V AC oder 24 V DC
- Zwei extern umschaltbare Messbereiche von 20 ... 600 A AC
- Zwei gleichzeitig verfügbare analoge Messausgänge
- Programmierbare Ausgangskennlinienverläufe
- Stromkreisüberwachung durch programmierbare Schaltschwellen
- Ausgabe der Betriebszustände über zwei Open-Kollektor-Transistoren bei gleichzeitiger Signalisierung über farbige Licht-Emitter-Dioden
- Aufbaueinheit für 35 mm DIN-Hutschiene

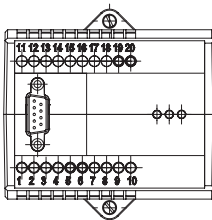
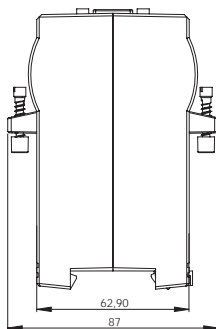
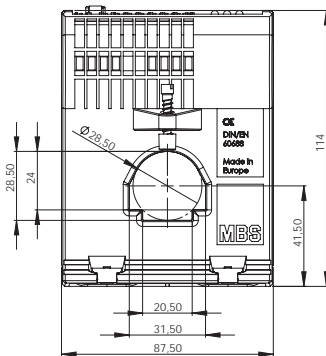

Anwendung

Programmierbarer Messumformer zur Erfassung von sowohl sinusförmigen als auch verzerrten Wechselströmen im Nennstrombereich von 20 ... 600 A. Induktive, galvanisch getrennte **Messwerterfassung durch einen integrierten Stromwandler**.

Als Ausgangssignal stehen ein zum Echteffektivwert (RMS-Wert) der Messgröße proportionales eingprägtes Gleichstromsignal und ein aufgeprägtes Gleichspannungssignal zur Verfügung.

Durch eine im Gerät integrierte serielle **RS232-Schnittstelle** werden folgende zusätzliche Leistungsmerkmale ermöglicht:

- Einstellung der Ausgangskennlinien der Analogausgänge 0(4) ... 20 mA und 0(2) ... 10 V
- Nennstromüberwachung mittels zweier programmierbarer Schaltschwellen
- Optische Signalisierung des momentanen Wertes der Messgröße in Abhängigkeit von den eingestellten Schaltschwellen durch drei farbige Licht-Emitter-Dioden
- Auslösung von Schalthandlungen (z. B. I_{Min} / I_{Max} -Erfassung) durch zwei, den eingestellten Schaltschwellen zugeordneten, Open-Kollektor-Transistoren
- Kontinuierliche Messwerterfassung und Datenspeicherung bei Kopplung mit externer Rechentechnik (Laptop, PC, ...)



Technische Kennwerte

Messeingang	
Messgröße	sinusförmiger oder verzerrter Wechselstrom
Messbereich	20...600 A AC
Nennfrequenz f_N	50 Hz oder 60 Hz
Eigenverbrauch	< 0,5 VA
Überlastbarkeit	1,5 x I_N , dauernd 8 x I_N , 40 Sek.
Messausgang	
Eingeprägter Gleichstrom	0...20 mA bzw. live-zero 4...20 mA parametrierbar über Software
Max. Bürdenspannung	≤ 15 V DC
Max. Bürdenwiderstand	≤ 500 Ω
Restwelligkeit des Ausgangsstromes	< 0,5 % p.p.
Strombegrenzung bei Überlast	≤ 30 mA
Aufgeprägte Gleichspannung	
unipolar	0...10 V bzw. live-zero 2...10 V parametrierbar über Software
Min. Bürdenwiderstand	≤ 10 kΩ
Spannungsbegrenzung bei $R_{EXT} = \infty$	≤ 15 V

Einstellzeit der Ausgangsgrößen	50 ms
Genauigkeit	
Bezugswert	Ausgangsnennwert
Grundgenauigkeit	Klasse 0,5 (0,5% vom Ausgangsendwert)
Arbeitsbereich	1...120% I_N
Anwärmzeit	≤ 5 min
Hilfsenergie	
AC	230 V ±10%
DC (optional)	24 V ±15%
Einsatzbedingungen	
Verwendungsort	Innenräume ohne Betauung
Einsatztemperatur	-5 °C bis +45 °C
Lagertemperatur	-40 °C bis +70 °C
Schaltausgänge	
2 Transistorenendstufen (Open-Kollektor)	ermöglichen die laststrom-abhängige Ansteuerung von Relaisschaltungen; Schaltschwellen parametrierbar über Gerätesoftware
U_{CEmax}	50 V
I_{CEmax}	35 mA
Schnittstelle	
Seriell	RS232, Anschluss über 9-poligen SUB-D-Stecker
Normen	IEC 60688 IEC 61000

Bestelltablelle siehe Seite 363

SWMU

NMC

NMC-AD

NMC-KSX

EMBSIN

MT

Bestelllisten



MT 440

Programmierbarer Messumformer für alle elektrischen Größen



Merkmale / Nutzen

- Mit Weitbereichs-Hilfsspannungsversorgung
- Aufbaugehäuse für 35 mm DIN-Hutschiene
- Erfassung von bis zu 50 verschiedenen Messgrößen (V, A, kW, kVA, ...)
- Multifunktionaler Messumformer mit 4 frei parametrierbaren Messausgängen
- Messausgänge parametrierbar als Analogausgang, Impulsausgang, Relaisausgang oder Steuerausgang
- Serielle Schnittstelle RS232 oder RS485
- Kommunikationsprotokoll MODBUS RTU
- Automatische Messbereichswahl der Strom- und Spannungseingänge
- Nennfrequenz der Eingangsgrößen 50/60 Hz oder 400 Hz

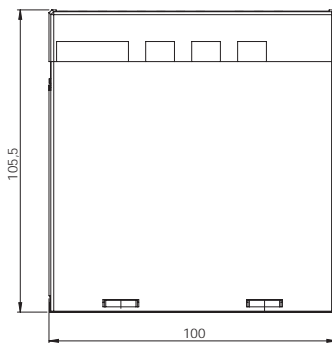

Anwendung

Der programmierbare Messumformer MT 440 ermöglicht die Erfassung von bis zu 50 verschiedenen elektrischen Kenngrößen des angeschlossenen Netzes.

Große Nennbereiche der Eingangsgrößen gestatten die Erfassung nahezu aller elektrischer Leistungsparameter standardisierter Netze.

Vier im Gerät integrierte, ebenfalls frei parametrierbare Messausgänge gestatten die gleichzeitige Nutzung der jeweils zugeordneten Messgröße für Steuer- und Regelungszwecke.

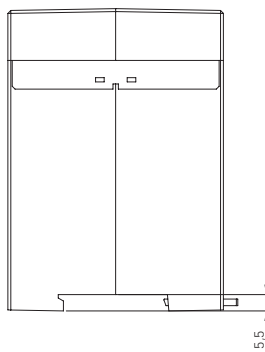
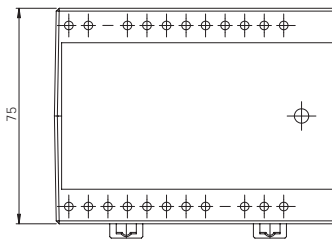



Technische Kennwerte

Messeingang	
Eingangsnennspannung U_N	500 V (Phase gegen Neutralleiter) Automatische Messbereichswahl
Spannungsmessbereiche	62,5 V, 125 V, 250 V, 500 V
Eingangsnennstrom I_N	5 A
Strommessbereiche	1 A, 5A, 10 A
Überlastbarkeit	
Stromeingang (gem. IEC 60688)	15 A dauernd; 20 x I_N , 5 x 1 Sek.
Spannungseingang (gem. IEC 60688)	600 V dauernd; 2 x U_N , 10 Sek.
Messausgang	
DC-Stromausgänge	
4 Ausgangsbereiche, parametrierbar	-100 % ... 0 ... 100 % -(1...20) mA ... 0 ... (1...20) mA
Regelbereich	$\pm 120\% I_{AN}$
Max. Bürdenspannung	≤ 10 V
Max. Ausgangsstrom bei Überlast	35 mA
Max. Ausgangsspannung bei offenem Stromausgang	35 V
Max. Bürdenwiderstand	$R_{max} [k\Omega] = 10 \text{ V} / I_{AN} [mA]$
Einstellzeit	≤ 100 ms
Restwelligkeit des Ausgangsstromes	$\leq 1\%$ p.p.
DC Spannungsausgänge	
2 Ausgangsbereiche, parametrierbar	-100 % ... 0 ... 100 % -(1...10) V ... 0 ... (1...10) V
Regelbereich	$\pm 120\%$
Max. Ausgangsspannung bei Überlast	
Max. Ausgangsstrom	20 mA
Min. Bürdenwiderstand	$R_{BMIN} [k\Omega] \geq U_{AN} / 20 \text{ mA}$
Einstellzeit	≤ 100 ms
Restwelligkeit der Ausgangsspannung	$\leq 1\%$ p.p.
Genauigkeit	
IEC 60688	Klasse 0,5
Hilfsenergie	
Allstromnetzteil	AC 40...276 V, (45...65 Hz) DC 24...300 V

Leistungsaufnahme	≤ 8 VA
Referenzbedingungen	
Umgebungstemperatur	15...30 °C
Eingangsgröße	0...100% I_N
Frequenz	45...65 Hz
Elektrische Anschlüsse	
Schraubklemmen	2,5 mm ² , Litze mit Aderendhülse 4,0 mm ² , Massivleiter
Parametriersoftware	MiQen Software zur Kommunikation und Parametrierung des Messumformers
Schnittstellen (optional)	RS232 bzw. RS485
Einsatzbedingungen	
Umgebungstemperatur	-10...0...45...55° C
Einsatztemperatur	-30 ... +70 °C
Lagertemperatur	-40 ... +70 °C
Mittlere Luftfeuchte	$\leq 93\%$
Einsatzhöhe	≤ 2000 m
Sicherheit	
Schutzklasse	IP 40 (IP 20 für Anschlussklemmen)
Verschmutzungsgrad	2
Messkategorie (EN61010-1)	CAT III; 600 V, Messeingänge; CAT III; 300 V, Hilfsspannungseingang
Prüfspannungen (DIN 57411)	3320 V AC _{RMS} , Hilfsspannung gegen Eingang / Ausgang / Schnittstelle 3320 V AC _{RMS} , Hilfsspannung gegen Stromeingang / Spannungseingang 3320 V AC _{RMS} , Stromeingang gegen Spannungseingang
Gehäusematerial	PC / ABS, UL 94 V-0
Normen	EN 61010-1; 2001 EN 60688; 1995 / A2; 2001 EN 61326-1; 2006 EN 60529; 1997 / A1; 2000
Normen	EN 60068-2-1/ -2/ -6/ -27/ -30
Abmessungen (B x H x T)	100 x 105 x 75 mm
Gewicht	370 g



MT 440

Programmierbarer Messumformer für alle elektrischen Größen

Anschlusschema

Die Spannungseingänge des Messumformers können direkt an ein Niederspannungsnetz oder über einen Hochspannungswandler an ein Hochspannungsnetz angeschlossen werden. Die Stromeingänge des Messumformers können direkt über einen Niederspannungs-Stromwandler an ein Niederspannungsnetz oder über einen Hochspannungs-Stromwandler an ein Hochspannungsnetz angeschlossen werden.

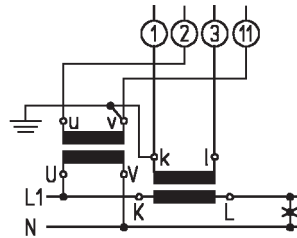

Einphasen-System – 1b

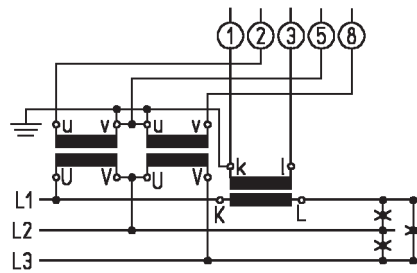

Dreileiter-Drehstromnetz – 3b, gleich belastet

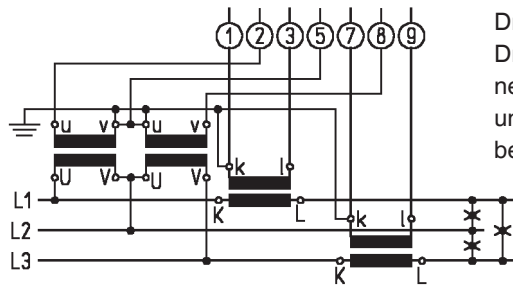

Dreiphasen-Drehstromnetz – 3u, ungleich belastet

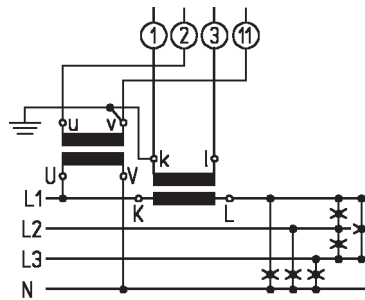

Vierleiter-Drehstromnetz – 4b, gleich belastet

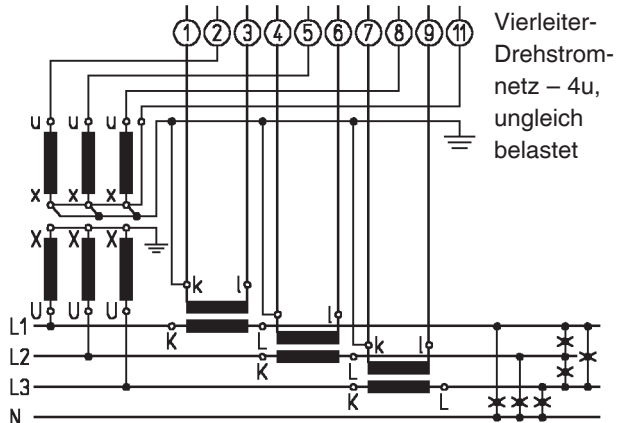

Vierleiter-Drehstromnetz – 4u, ungleich belastet

Funktion		Anschluss	
Messeingang	AC-Strom	I_{L1}	1/3
		I_{L2}	4/6
		I_{L3}	7/9
	AC-Spannung	U_{L1}	2
		U_{L2}	5
		U_{L3}	8
N		11	
Eingang/ Ausgang	Ausgang 1	$\omega +$	15
		$\omega \vartheta$	16
	Ausgang 2	$\omega +$	17
		$\omega \vartheta$	18
	Ausgang 3	$\omega +$	19
		$\omega \vartheta$	20
	Ausgang 4	$\omega +$	21
		$\omega \vartheta$	22
Hilfsspannungsversorgung		+ / AC (L)	13
		- / AC (N)	14
Schnittstelle	RS232/RS485	R_x A	23
		GDN / NC ¹⁾	24
		T_x / B	25

Anschlüsse

¹⁾ -NC- nicht belegen



Bestelllisten

		Seite
EMBSIN 100 I	Messumformer für Wechselstrom, ohne Hilfsspannungsversorgung	354
EMBSIN 101 I	Messumformer für Wechselstrom, mit Hilfsspannungsversorgung	355
EMBSIN 201 IE	Messumformer für Wechselstrom, Echt-Effektivwert-Messung (RMS)	356
EMBSIN 120 U	Messumformer für Wechselspannung, ohne Hilfsspannungsversorgung	357
EMBSIN 121 U	Messumformer für Wechselspannung, mit Hilfsspannungsversorgung	355
EMBSIN 221 UE	Messumformer für Wechselspannung, Echt-Effektivwert-Messung	356
EMBSIN 241 F	Messumformer für Frequenz, mit universellem AC/DC-Netzteil.	358
EMBSIN 241 FD	Messumformer für Frequenzdifferenz, mit universellem AC/DC-Netzteil.	358
EMBSIN 271 G	Messumformer für Phasenwinkel, mit universellem AC/DC-Netzteil	359
EMBSIN 271 GD	Messumformer für Phasenwinkeldifferenz, mit universellem AC/DC-Netzteil	361
EMBSIN 281 G	Messumformer für Leistungsfaktor, mit universellem AC/DC-Netzteil	359
EMBSIN 351 P	Messumformer für Wirkleistung, mit universellem AC/DC-Netzteil	362
EMBSIN 361 Q	Messumformer für Blindleistung, mit universellem AC/DC-Netzteil	362
EMBSIN 301	Programmierbarer Messumformer für Wechselstrom	363
MT440	Programmierbarer Messumformer für alle elektrischen Größen	363



Bestelllisten

EMBSIN 100 I – Messumformer für Wechselstrom, ohne Hilfsspannungsversorgung

Merkmale	Bestellnummer					
EMBSIN 100 I, Messumformer für Wechselstrom Best.-Nr.: 100 I – Mxxxx	100 I –	M	X	X	X	X
1. Bauform Aufbaugeschäuse MBS, für 35-mm-DIN-Hutschiene		M				
2. Messbereich 0...1/5 A				1		
0...1,2/6 A				2		
9 Nichtnorm (A), 0...0,5 A bis 0...7,5 A (nur ein Messbereich!) _____ A				9		
3. Ausgangssignal 0...5 mA, $R_a \leq 3 \text{ k}\Omega$				1		
0...10 mA, $R_a \leq 1,5 \text{ k}\Omega$				2		
0...20 mA, $R_a \leq 750 \Omega$				3		
4. Messbereich einstellbar Messbereich fest eingestellt					0	
Messbereich-Endwert einstellbar ca. $\pm 10\%$					1	
5. Prüfprotokolle ohne Prüfprotokoll						0
mit deutschem Prüfprotokoll						D
mit englischem Prüfprotokoll						E

Nennfrequenz der Messgröße: 50/60 Hz



Bestelllisten

EMBSIN 101 I/121 U – Messumformer für Wechselstrom/Wechselspannung

Merkmale	Bestellnummer							
EMBSIN 101 I, Messumformer für Wechselstrom Best.-Nr. 101 I – Mxx xx	101 I –	M	X	X		X	X	X
EMBSIN 121 U, Messumformer für Wechselspannung Best.-Nr. 121 U – Mx xxx	121 U –	M	X		X	X	X	
1. Bauform Aufbaugeschäube, MBS/SP1, für 35-mm-DIN-Hutschienenmontage		M						
2. Frequenz der Eingangsspannung des Eingangsstromes								
Nennfrequenz 50/60 Hz			1					
3. Messbereich								
0...1 A				A				
0...5 A				B				
Z) _____ A ! Z) Nichtnorm [A] 0...0,8 bis 0...1,2 oder 0...4 bis 0...6				Z				
0...100 V					A			
0...250 V					B			
0...500 V					C			
Z) _____ V ! Z) Nichtnorm (V) 0...50 bis 0...500 Max. 300 V Nennspannung des Netzes gegen Erde (Nennspannungen gemäß EN 61010)					Z			
4. Ausgangssignal								
0...20 mA						1		
4...20 mA						2		
4...20 mA, 2 – Draht – Anschluss/Speisung						3		
9) _____ mA ! 9) Nichtnorm [mA] 0...2,5 bis 0...< 20 1...5 bis < (4... 20)						9		
0...10 V						A		
Z) _____ V ! Z) Nichtnorm (V) 0...5,0 bis 0...< 10 1...5 bis 2...10						Z		
5. Hilfsenergie								
Hilfsspannung U_h : 24 V AC							1	
Hilfsspannung U_h : 110 V AC							2	
Hilfsspannung U_h : 115 V AC							3	
Hilfsspannung U_h : 120 V AC							4	
Hilfsspannung U_h : 230 V AC							5	
Hilfsspannung U_h : 400 V AC, ! max. 300 V gegen Erde!							6	
Hilfsspannung U_h : 24 V DC							A	
Hilfsspannung U_h : 24 V DC über Ausgangskreis							B	
Hilfsspannung U_h : 85...230 V AC/DC							C	
Hilfsspannung U_h : 24...60 V AC/DC							D	
U_h ...Nennspannung zulässige Toleranzen für AC –15...+33% zulässige Toleranzen für DC –15...+15% zulässige Toleranzen für DC über Ausgangskreis –50...+33% ! 1) bis A) nicht kombinierbar mit Ausgangssignal Best.-Nr.: 3) ! B) nicht kombinierbar mit Ausgangssignal Best.-Nr.: 1), 2), 9), A), Z)								
6. Prüfprotokolle								
ohne Prüfprotokoll								0
mit Prüfprotokoll deutsch								D
mit Prüfprotokoll englisch								E



MBS AG



Bestelllisten

EMBSIN 201 IE/221 UE – Messumformer für Wechselstrom/Wechselspannung, Effektivwertmessung

Merkmal	Bestellnummer									
EMBSIN 201 IE, Wechselstrom-Messumformer Effektivwert, Best.-Nr.: 201 IE - Mxx xx x	201 IE –	M	X	X		X	X		X	X
EMBSIN 221 UE, Wechselspannungs-Messumformer Effektivwert, Best.-Nr. 221 UE – Mx xx xx	221 UE –	M	X			X	X		X	X
1. Bauform Aufbaugehäuse, MBS/SP2, für DIN-Hutschienenmontage		M								
2. Frequenz der Eingangsspannung des Eingangsstromes										
Nennfrequenz 50 60 Hz									1	
Nennfrequenz 400 Hz									2	
3. Messbereiche										
0...1,0/5,0 A									1	
0...1,2/6,0 A									2	
9) _____ A Niedrigerer höherer Messbereich je nach Anschluss ! Z) Nichtnorm [A] 0...0,1/0,5 bis 0...<1,2/6 Messbereichsendwert Verhältnis 1:5									9	
0...100/ $\sqrt{3}$ V									A	
0...110/ $\sqrt{3}$ V									B	
0...100 V									C	
0...110 V									D	
0...116,66 V									E	
0...120 V									F	
0...125 V									G	
0...133,33 V									H	
0...150 V									J	
0...250 V									K	
0...500 V									L	
Z) _____ V ! Z) Nichtnorm (V): 0...20 bis 0...690 * bei Hilfsspannung ab Messeingang min 24 V/max 230 V ! siehe Auswahlkriterium 5 Ziffer 3) + 4) ! * > 400 V nur verkettete Spannung !									Z	
4. Ausgangssignal										
0...20 mA									1	
4...20 mA									2	
9) _____ mA ! 9) Nichtnorm [mA]: 0...1,00 bis 0...< 20 0,2...1 bis < (4...20)									9	
A) 0...10 V									A	
Z) _____ V ! Z) Nichtnorm (V): 0...1,00 bis 0...< 10 0,2...1 bis 2...10									Z	
5. Hilfsspannung										
Hilfsspannung U_h : 85...230 V AC/DC 1									1	1
Hilfsspannung U_h : 24...60 V AC/DC 2									2	2
Hilfsspannung ab Messeingang ($\geq 24...60$ V AC)										3
Hilfsspannung ab Messeingang ($\geq 85...230$ V AC)										4
Hilfsspannung U_h : 24 V AC/24...60 V DC ab Niederspannungsseite									5	5
U_h ...Nennspannung Toleranzen: DC -15...+33 % AC -15...+15 % ! 3) Nicht kombinierbar mit Messbereich-Best.-Nr.: C)...L) ! 4) Nicht kombinierbar mit Messbereich-Best.-Nr.: A, B, L										
6. Einstellzeit										
300 ms (Standard)									1	
50 ms									2	
7. Prüfprotokolle										
ohne Prüfprotokoll										0
mit Prüfprotokoll deutsch										D
mit Prüfprotokoll englisch										E



Bestelllisten

EMBSIN 120 U – Messumformer für Wechselspannung, ohne Hilfsspannung

Merkmale	Bestellnummer					
	120 U –	M	X	X	X	X
EMBSIN 120 U, Messumformer für Wechselspannung Best.-Nr.: 120 U – Mxxxx						
1. Bauform Aufbaugehäuse MBS/SP1, für 35-mm-DIN-Hutschiene		M				
2. Messbereich						
0...100/ $\sqrt{3}$ V			A			
0...110/ $\sqrt{3}$ V			B			
0...120/ $\sqrt{3}$ V			C			
0...100 V			D			
0...110 V			E			
0...116,66 V			F			
0...120 V			G			
0...125 V			H			
0...133,33 V			J			
0...150 V			K			
0...250 V			L			
0...400 V			M			
0...500 V !			N			
Z) _____ V ! Z) Nichtnorm (V): 0...20 V bis 0...500 V max. 250 V Nennspannung gegen Erde (Nennspannungen gemäß EN 61010)			Z			
3. Ausgangssignal						
0...5 mA, $R_a \leq 3 \text{ k}\Omega$				1		
0...10 mA, $R_a \leq 1,5 \text{ k}\Omega$				2		
0...20 mA, $R_a \leq 750 \Omega$				3		
4. Messbereich einstellbar						
Messbereich fest eingestellt				0		
Messbereich – Endwert einstellbar ca. $\pm 10\%$				1		
5. Prüfprotokolle						
ohne Prüfprotokoll						0
mit Prüfprotokoll deutsch						D
mit Prüfprotokoll englisch						E



Bestelllisten

EMBSIN 241 F/241 FD – Messumformer für Frequenz/Frequenzdifferenz

Merkmal	Bestellnummer								
EMBSIN 241 F, Frequenz-Messumformer Effektivwert, Best.-Nr.: 241 F – Mxx xx x	241 F –	M	X	X		X	X	X	X
EMBSIN 241 FD, Frequenz-Messumformer Effektivwert, Best.-Nr.: 241 FD – Mxx xx x	241 FD –	M	X		X	X	X	X	X
1. Bauform Aufbaugeschäse, MBS/SP2, für 35-mm-DIN-Hutschiene		M							
2. Eingangs-Nennspannung bei EMBSIN 241 FD → Generator und Sammelschiene Eingangsspannung									
10...230 V								1	
> 230...690 V ! 3-Leiter-System: Eingangsspannung = verkettete Spannung ! 2) nicht zulässig bei Hilfsspannung ab Messeingang								2	
3. Messbereiche									
45...50...55 Hz								1	
47...49...51 Hz								2	
47,5...50...52,5 Hz								3	
48...50...52 Hz								4	
58...60...62 Hz								5	
9) _____ Hz ! 9) Nichtnorm [Hz]; Grenzwerte: Anfangswert $f_a \geq 10$, Endwert $f_e \leq 1500$ $f_a/(f_e-f_a) < 50$								9	
$f_s = 50 \text{ Hz}/f_g = 49,5...50...50,5 \text{ Hz}$								1	
$f_s = 50 \text{ Hz}/f_g = 47,5...50...52,5 \text{ Hz}$								2	
$f_s = 50 \text{ Hz}/f_g = 45...50...55 \text{ Hz}$								3	
$f_s = 50 \text{ Hz}/f_g = 40...50...60 \text{ Hz}$								4	
$f_s = 60 \text{ Hz}/f_g = 57,5...60...62,5 \text{ Hz}$								5	
9) _____ Hz ! 90) Nichtnorm [Hz]: auf Anfrage								9	
4. Ausgangssignal									
0...20 mA								1	
4...20 mA								2	
9) _____ V ! 9) Nichtnorm [mA]: 0...1,00 bis 0...< 20, -1,00...0...1,00 bis -20...0...20, 1...5 bis < (4...20)								9	
0...10 V								A	
Z) _____ V ! Z) Nichtnorm (V): 0...1,00 bis 0...< 10, 0,2...1 bis 2...10 -1,00...0...1,00 bis -10...0...10								Z	
5. Hilfsspannung									
Hilfsspannung U_h : 85...230 V AC/DC								1	
Hilfsspannung U_h : 24...60 V AC/DC								2	
Hilfsspannung ab Messeingang ($\cong 24...60 \text{ V AC}$)								3	
Hilfsspannung ab Messeingang ($\cong 85...230 \text{ V AC}$)								4	
Hilfsspannung U_h : 24 V AC/24...60 V DC ab Niederspannungsseite								5	
U_h ...Nennspannung Toleranzen: DC -15...+33%, AC -15...+15% ! 3) + 4): Nicht kombinierbar mit Eingangs-Nennspannung, Best.-Nr.: 2)									
6. Einstellzeit									
Einstellzeit 4 Perioden der Eingangsfrequenz (Standard)								1	
Einstellzeit 2 Perioden der Eingangsfrequenz								2	
Einstellzeit 8 Perioden der Eingangsfrequenz								3	
Einstellzeit 16 Perioden der Eingangsfrequenz ! 1) Einstellzeit 4 Perioden = Standard								4	
7. Prüfprotokolle									
ohne Prüfprotokoll									0
mit Prüfprotokoll deutsch									D
mit Prüfprotokoll englisch									E



Bestelllisten

EMBSIN 271 G/281 G – Messumformer für Phasenwinkel/Leistungsfaktor

Merkmal	Bestellnummer												
EMBSIN 271 G, Phasenwinkel-Messumformer Best.-Nr.: 271 G – Mxxxxxxx	271G –	M	X	X	X	X	X	X	X	X	X	X	X
EMBSIN 281 G, Leistungsfaktor-Messumformer Best.-Nr.: 281 G – Mxxxxxxx	281G –	M	X	X	X	X	X	X	X	X	X	X	X
1. Bauform Aufbaugehäuse, MBS/SP2, für 35-mm-DIN-Hutschiene		M											
2. Messart													
1) Für Phasenwinkel (proportional φ)												1	
2) Für Leistungsfaktor (proportional $\cos \varphi$)												2	
3. Anwendung													
Einphasen-Wechselstrom												1	
3- oder 4-Leiter-Drehstrom, gleich belastet $U: L_1-L_2; I: L_1$												2	
3- oder 4-Leiter-Drehstrom, gleich belastet $U: L_2-L_3; I: L_2$												3	
3- oder 4-Leiter-Drehstrom, gleich belastet $U: L_3-L_1; I: L_3$												4	
3- oder 4-Leiter-Drehstrom, gleich belastet $U: L_1-L_3; I: L_1$												5	
3- oder 4-Leiter-Drehstrom, gleich belastet $U: L_2-L_1; I: L_2$												6	
3- oder 4-Leiter-Drehstrom, gleich belastet $U: L_3-L_2; I: L_3$												7	
3- oder 4-Leiter-Drehstrom, gleich belastet $U: L_1-L_2; I: L_3$												A	
3- oder 4-Leiter-Drehstrom, gleich belastet $U: L_2-L_3; I: L_1$												B	
3- oder 4-Leiter-Drehstrom, gleich belastet $U: L_3-L_1; I: L_2$												C	
4. Eingangs-Nennfrequenz													
Nennfrequenz 50 Hz												1	
Nennfrequenz 60 Hz												2	
9) _____ Hz ! 9) Nichtnorm [Hz]: $10 \leq f_n \leq 400$ bei Hilfsspannung ab Messeingang minimal 40 Hz												9	
5. Eingangs-Nennspannung													
Eingangsspannung U_n : 100 V												1	
Eingangsspannung U_n : 230 V												2	
9) Eingangsspannung U_n : _____ V ! 3-Leiter-System: U_n = verkettete Spannung ! 9) Nichtnorm (V): $\geq 10,00$ bis 690 V Bei Hilfsspannung ab Messeingang min. 24 V/max. 230 V siehe Auswahlkriterium 9, Ziffer 3) und 4)												9	
6. Eingangs-Nennstrom													
Eingangsnennstrom I_n : 1 A												1	
Eingangsnennstrom I_n : 5 A												2	
9) Eingangsnennstrom I_n : _____ A												9	
7. Messbereiche													
Messbereich: $-60...0...60^\circ \text{el}$												1	
Messbereich $\cos \varphi$: 0,5...cap...1...ind...0,5												2	
9) Messbereich: _____ ! 1) Nicht kombinierbar mit Messart-Best.-Nr.: 2) ! 2) Nicht kombinierbar mit Messart-Best.-Nr.: 1) ! 9) Nichtnorm, Messbereich innerhalb 1...ind...0...cap...1...ind...0...cap...1 oder $-180...0...180^\circ \text{el}$ eindeutiger Ausgangswert jedoch nur bis $-175...0...175^\circ \text{el}$; jedoch Messspanne $\geq 20^\circ \text{el}$												9	



Bestelllisten

EMBSIN 271 GD – Messumformer für Phasenwinkeldifferenz

Merkmal	Bestellnummer								
	271GD –	M	X	X	X	X	X	X	X
EMBSIN 271 GD, Phasenwinkel-Messumformer Bestell.-Nr.: 271 GD – Mxxxxxxx									
1. Bauform Aufbaugehäuse, MBS/SP2, für 35-mm-DIN-Hutschiene		M							
2. Eingangs-Nennfrequenz									
Nennfrequenz 50 Hz						1			
Nennfrequenz 60 Hz						2			
9) Nennfrequenz _____ Hz ! 9) Nichtnorm [Hz]: ≥ 10 bis 1500 bei Hilfsspannung ab Messeingang: $40 \text{ Hz} \leq f_n \leq 400 \text{ Hz}$						9			
3. Eingangs-Nennspannung Generator und Sammelschiene!									
Eingangsspannung U_n : 100 V						1			
Eingangsspannung U_n : 230 V						2			
9) Eingangsspannung U_n : _____ V 3-Leiter-System: Eingangsspannung = verkettete Spannung ! 9) Nichtnorm (V): ≤ 10 bis 690, bei Hilfsspannung ab Messeingang min. 24 V/max. 230 V ! siehe Auswahlkriterium 6, Ziffer 3) + 4)						9			
4. Messbereich									
Messbereich: $-120^\circ \dots 0^\circ \dots +120^\circ$ el						1			
9) Messbereich: _____ $^\circ$ el ! 9) Nichtnorm [$^\circ$ el], Messbereiche innerhalb $-10 \dots 0 \dots 10$ bis $-180 \dots 0 \dots +180$ eindeutiger Ausgangswert jedoch nur bis $-175^\circ \dots 0 \dots +175^\circ$ el						9			
5. Ausgangssignal									
0...20 mA						1			
4...20 mA						2			
9) _____ mA ! 9) Nichtnorm [mA]: 0...1,00 bis 0...< 20 $-1,00 \dots 0 \dots 1,00$ bis $-20 \dots 0 \dots 20$ $1 \dots 5$ bis $< (4 \dots 20)$						9			
A) 0...10 V							A		
Z) _____ V ! Z) Nichtnorm (V): 0...1,00 bis 0...< 10 0,2...1 bis 2...10 $-1,00 \dots 0 \dots 1,00$ bis $-10 \dots 0 \dots 10$							Z		
6. Hilfsspannung									
Hilfsspannung U_h : 85...230 V AC/DC							1		
Hilfsspannung U_h : 24...60 V AC/DC							2		
Hilfsspannung ab Messeingang ($\geq 24 \dots 60 \text{ V AC}$)							3		
Hilfsspannung ab Messeingang ($\geq 85 \dots 230 \text{ V AC}$)							4		
Hilfsspannung U_h : 24 V AC/24...60 V DC ab Niederspannungsseite							5		
U_h = Nennspannung Toleranzen: DC $-15 \dots +33\%$ AC $-15 \dots +15\%$! 3) + 4): Nicht kombinierbar mit Eingangs-Nennspannung Best.-Nr.: 2)									
7. Einstellzeiten									
Einstellzeit 4 Perioden der Eingangsfrequenz ! 1) 4 Perioden = Standard							1		
Einstellzeit 2 Perioden der Eingangsfrequenz							2		
Einstellzeit 8 Perioden der Eingangsfrequenz							3		
Einstellzeit 16 Perioden der Eingangsfrequenz							4		
8. Prüfprotokolle									
ohne Prüfprotokoll									0
mit Prüfprotokoll deutsch									D
mit Prüfprotokoll englisch									E



Bestelllisten

EMBSIN 351 P/361 Q – Messumformer für Wirkleistung/Blindleistung

Merkmale	Bestellnummer														
EMBSIN 351 P, Wirkleistungs-Messumformer Best.-Nr.: 351 P – Mx xxxx xxx	351 P –	M	X	X	X	X	X	X	X		X	X	X	X	X
EMBSIN 361 Q, Blindleistungs-Messumformer Best.-Nr.: 361 Q – M xxxx xxxx	361 Q –	M		X	X	X	X			X	X	X	X	X	X
1. Bauform Aufbauehäuse, MBS/SP3, für 35-mm-DIN-Hutschiene		M													
2. Anwendung															
3-/4-Leiter-Drehstrom, gleich belastet ($U: L_1, L_2, L_3 I: L_1$)															1
3-Leiter-Drehstrom, ungleich belastet															2
4-Leiter-Drehstrom, ungleich belastet															3
3. Eingangs-Nennfrequenz															
...Nennfrequenz 50 Hz															1
...Nennfrequenz 60 Hz															2
4. Eingangs-Nennspannung															
Eingangsspannung															
U_n : 100...115 V; _____ V Werte angeben!															1
U_n : 200...230 V; _____ V															2
U_n : 380...440 V; _____ V															3
U_n : 600...690 V; _____ V															4
9) Nichtnorm U_n ; _____ V ! 1)...4): Effektive Nennspannungen angeben ! 9): Nichtnorm (V): > 115 bis < 600 Eingangsspannung U_n = verkettete Spannung !															9
5. Eingangs-Nennstrom															
Eingangsstrom I_n : 1 A															1
Eingangsstrom I_n : 5 A															2
6. Messbereich															
Messbereich bipolar: _____ W															1
Messbereich unipolar: _____ W															2
Messbereichsendwerte in Watt angeben, z.B. 500 W bei Messbereich bipolar –500...500 1000 W bei Messbereich unipolar 0...1000 zulässige Endwerte: $0,75...1,3 \times U_n \times I_n \times \sqrt{3}$ [W]															
Messbereich bipolar: _____ var															1
Messbereich unipolar: _____ var Messbereichsendwerte in var angeben, z.B. 500 var bei Messbereich bipolar –500...500 1000 var bei Messbereich unipolar 0...1000, zulässige Endwerte: $0,5...1,0 \times U_n \times I_n \times \sqrt{3}$ [var]															2
7. Ausgangssignal, Anfangswert															
Ausgang bipolar, Anfangswert –100% Endwert															1
Ausgang unipolar, Anfangswert 0															2
Ausgang Live-zero, Anfangswert = 20% Endwert ! 1) Ausgang bipolar nicht möglich mit Messbereich unipolar Messbereich-Best.-Nr.: 2)															3
8. Ausgangssignal, Endwert															
Ausgangssignal-Endwert: 20 mA															1
Ausgangssignal-Endwert: 10 mA															2
Ausgangssignal-Endwert: 5 mA															3
Ausgangssignal-Endwert: 2,5 mA															4
Ausgangssignal-Endwert: 10 V															A
9. Hilfsspannungsversorgung															
Hilfsspannung U_h : 85...230 V DC/AC															1
Hilfsspannung U_h : 24...60 V DC/AC															2
Hilfsspannung ab Messeingang ($\geq 85...230$ V AC)															4
Hilfsspannung U_h : 24 V AC/24...60 V DC Anschluss über Niederspannungsseite! Toleranzen: DC: –15...+ 33%; AC: –15...+15% ! 4) Nicht kombinierbar mit Eingangsnennspannung, Best.-Nr.: 3) und 4)															5
10. Zusatztext															
ohne Kundentext															0
mit Kundentext															1
11. Prüfprotokolle															
ohne Prüfprotokoll															0
mit Prüfprotokoll deutsch															D
mit Prüfprotokoll englisch															E



Bestelllisten

EMBSIN 301 – Messumformer für Wechselstrom, Echt-Effektivwert-Messung (RMS)

Hilfsspannung 230 V AC

Hilfsspannung 24 V DC

Bestellnummer	Messbereich
137112	30 / 15 A
137113	40 / 20 A
137114	50 / 25 A
137115	60 / 30 A
137117	100 / 50 A
137118	150 / 75 A
137119	200 / 100 A
137120	250 / 125 A
137121	300 / 150 A
137122	400 / 200 A
137123	500 / 250 A
137124	600 / 300 A

Bestellnummer	Messbereich
137212	30 / 15 A
137213	40 / 20 A
137214	50 / 25 A
137215	60 / 30 A
137217	100 / 50 A
137218	150 / 75 A
137219	200 / 100 A
137220	250 / 125 A
137221	300 / 150 A
137222	400 / 200 A
137223	500 / 250 A
137224	600 / 300 A

MT 440 – Programmierbarer Messumformer für alle elektrischen Leistungsgrößen

Merkmale	Bestellnummer										
MT 440, programmierbarer Messumformer für alle elektrischen Leistungsgrößen Best.-Nr.: MT 440 – Vxxxxxxxx	440 –	V	X	X	X			X	X	X	X
1. Anwendung											
1) 1-Phasen-Wechselstromnetz										1	
2) 3-Leiter-Drehstrom, gleich belastet										2	
3) 3-Leiter-Drehstrom, ungleich belastet										3	
4) 4-Leiter-Drehstrom, gleich belastet										4	
5) 4-Leiter-Drehstrom, ungleich belastet										5	
2. Nennbereich der Eingangsspannung											
Eingangsspannung Direktanschluss											
A) Eingangsspannung über Spannungswandler											
0...50 V AC (verkettete Spannung!) Wert angeben!										1	
0...500 V AC (verkettete Spannung!) Wert angeben!										2	
3. Nennwert des Eingangstromes											
B) Eingangsstrom über Stromwandler											
1) 0...0,5 A AC, Wert angeben!										1	
2) 0...5,0 A AC, Wert angeben!										2	
4. Hilfsspannung											
1) Universalnetzteil (24...300 V DC/ 40...276 V AC) AC-Versorgungsspannung (!)									1	0	
5. Typ der seriellen Schnittstelle											
RS232											1
RS485											2
6. Auslieferungszustand											
Gerät nicht parametrierbar											0
Gerät parametrierbar nach Kundenspezifikation											1





Energiezähler

Einphasen-Energiezähler

			Seite
ECP6112 / ECP6152	2-Leiter	S0-Impulsausgang	5 (32) A 366
EMU7754	2-Leiter	M-Bus Schnittstelle	5 (63) A 367
ECP6156	2-Leiter	S0-Impulsausgang	5 (80) A 368

Dreiphasen-Energiezähler

ECP1151	4-Leiter	S0-Impulsausgang	10 (100) A 369
ECP1155	4-Leiter	S0-Impulsausgang	x/5 A 370

Dreiphasen-Energiezähler mit MID-Zulassung

MBS Allrounder		 374
MBS Professional		 376



ECP 6112 / ECP 6152

1-Phasen Energiezähler

Merkmale / Nutzen

- Direktanschluss bis 32 A
- Genauigkeitsklasse 1
- S0 Impulsausgang
- elektromechanisches Energiezählwerk oder LCD-Anzeige

Anwendung

Elektronischer Energiezähler zur Erfassung der elektrischen Wirkenergie in Wechselstromnetzen.

Der Energiezähler findet Anwendung in Industrieunternehmen, im Schaltanlagenbau, im Gewerbe sowie bei Privatnutzern.

Mit dem S0 Impulsausgang ist die Weiterverarbeitung der gemessenen Energiedaten, wie z.B. für die Kostenstellenabrechnung, Gebäudeleittechnik und Energiemanagement gewährleistet.

Technische Kennwerte

Messeingang

Eingangsnennspannung U_N	230 V AC Spannungsbereich: -20 % ... +15 %
Messbereich	5(32) A
Anlaufstrom	20 mA
Nennfrequenz f_N	50 Hz Frequenzbereich: 50...60 Hz
Eigenverbrauch	< 0,4 W / Phase

S0 Schnittstelle nach EN 62053-31

Impulswertigkeit	1000 Impulse pro kWh
Maximalspannung	27 V DC
Strom	10 ... 27 mA

Anzeige

Elektromechanisches Zählwerk oder LCD-Anzeige	Größe 2,0 x 4 mm, 7-stellig, eine Dezimalstelle (000000,0 kWh)
Weitere Anzeigedaten	Last-LED: 1000 Impulse pro kWh

Weitere Informationen

Genauigkeitsklasse	1
Vorsicherung	max. 32 A
Gewicht	80 g
Montage	Hutschiene nach EN 60715
Einsatztemperatur	-25 ... +55 °C
Anschluss S0 Impuls	1 ... 6 mm ²
Anschluss Messeingang	1 ... 6 mm ²

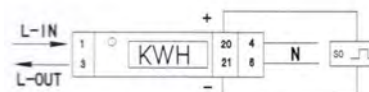
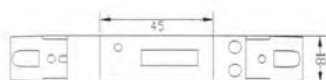
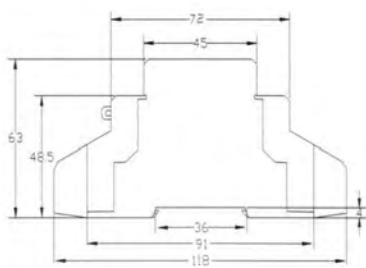

Best.-Nr.	S0 Impulsausgang	Elektromechanische Anzeige	LCD-Anzeige	Strombereich in A
ECP6112	•	•		32
ECP6152	•		•	32

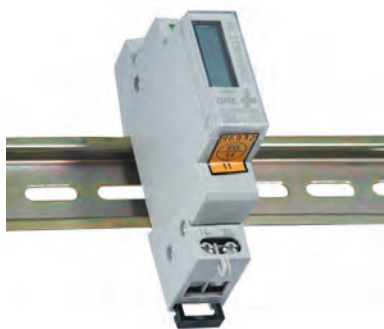

EMU 7754

1-Phasen Energiezähler

Merkmale / Nutzen

- Direktanschluss bis 63 A
- Genauigkeitsklasse 1 gemäß EN 62053-21
- M-Bus Schnittstelle
- geeicht
- zur Verrechnung einsetzbar

Anwendung

Elektronischer Energiezähler zur Erfassung der elektrischen Wirkenergie in Wechselstromnetzen.

Der Energiezähler findet Anwendung in Industrieunternehmen, im Schaltanlagenbau, im Gewerbe sowie bei Privatnutzern.

Mit der M-Bus Schnittstelle ist die Weiterverarbeitung der gemessenen Energiedaten, wie z.B. für Kostenstellenabrechnung, Gebäudeleittechnik und Energiemanagement gewährleistet.

Technische Kennwerte

Messeingang	
Eingangsnennspannung U_N	230 V AC
Messbereich	5(63) A
Anlaufstrom	25 mA
Nennfrequenz f_N	50 Hz
Eigenverbrauch	0,4 W
Anzeige	
Energiezählwerk	LCD, 6-stellig, eine Dezimalstelle (00000,0 kWh)
Weitere Informationen	
Vorsicherung	max. 63 A
Gewicht	80 g
Montage	Hutschiene nach EN 60715
Einsatztemperatur	-10 ... +45 °C
Anschluss Messeingang	max. 16 mm ²

M-Bus	
M-Bus Schnittstelle nach	EN 13757-2,3
Adressierung	die Primär- und Sekundäradresse ist einstellbar
Auslesedaten	Wirkenergie (kW) Spannung (V), Strom (A) Seriennummer Momentanleistung (W)
Messgenauigkeit	
Klasse 1	
Sicherheit	
Schutzklasse	IP 51
Anschlussbedingungen	
M-Bus Klemmen	max. 0,75 mm ²

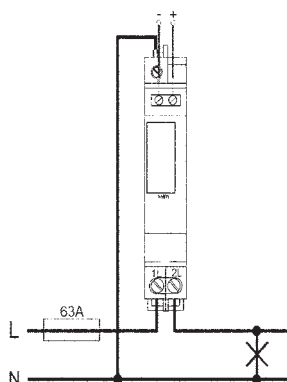
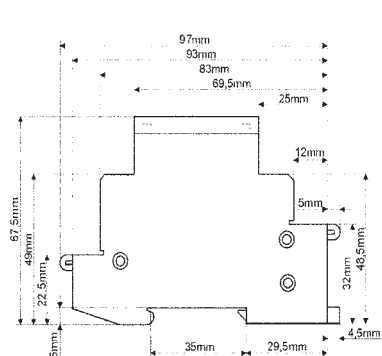

Best.-Nr.	S0 Impulsausgang	M-Bus Ausgang	LCD-Anzeige	Strombereich in A
EMU7754		•	•	63



ECP 6156

1-Phasen Energiezähler

Merkmale / Nutzen

- Direktanschluss bis 80 A
- Genauigkeitsklasse 1
- S0 Impulsausgang
- 2. LCD Energieanzeige rückstellbar

Anwendung

Elektronischer Energiezähler zur Erfassung der elektrischen Wirkenergie in Wechselstromnetzen.

Der Energiezähler findet Anwendung in Industrieunternehmen, im Schaltanlagenbau, im Gewerbe sowie bei Privatnutzern.

Mit dem S0 Impulsausgang ist die Weiterverarbeitung der gemessenen Energiedaten, wie z.B. für die Kostenstellenabrechnung, Gebäudeleittechnik und Energiemanagement gewährleistet.

Technische Kennwerte

Messeingang

Eingangsnennspannung U_N	230 V AC Spannungsbereich: -20 % ... +15 %
Messbereich	5(80)A
Anlaufstrom	20 mA
Nennfrequenz f_N	50 Hz Frequenzbereich: 50...60 Hz
Eigenverbrauch	0,6 W
S0 Schnittstelle nach EN 62053-31	
Impulswertigkeit	1000 Impulse pro kWh
Maximalspannung	30 V DC
Minimalspannung	5 V DC
Strom	20 mA

Anzeige

Energiezählwerk	LCD, Grösse 2,0 x 4 mm, 7-stellig, eine Dezimalstelle (000000,0 kWh)
-----------------	--

Weitere Anzeigedaten	Last-LED: 1000 Impulse pro kWh
----------------------	-----------------------------------

Weitere Informationen

Genauigkeitsklasse	1 (gemäß IEC 62052-11)
Gewicht	80 g
Montage	Hutschiene nach EN 60715
Einsatztemperatur	-25 ... +55 °C
Anschluss Messeingang	25 mm ²

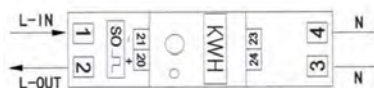
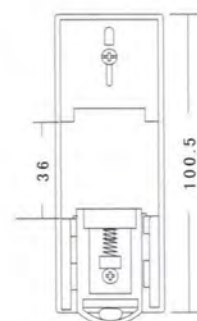
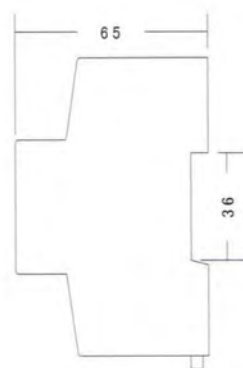
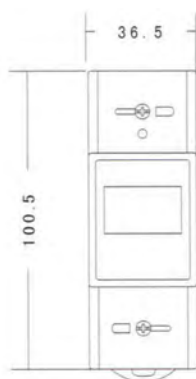

Best.-Nr.	S0 Impulsausgang	Elektromechanische Anzeige	LCD-Anzeige	Strombereich in A
ECP6156	•		•	80



ECP 1151

3-Phasen Energiezähler

Merkmale / Nutzen

- Direktanschluss bis 100 A
- Genauigkeitsklasse 1
- S0 Impulsausgang

Anwendung

Elektronischer Energiezähler zur Erfassung der elektrischen Wirkenergie in Wechselstromnetzen.

Der Energiezähler findet Anwendung in Industrieunternehmen, im Schaltanlagenbau, im Gewerbe sowie bei Privatnutzern.

Mit dem S0 Impulsausgang ist die Weiterverarbeitung der gemessenen Energiedaten, wie z.B. für die Kostenstellenabrechnung, Gebäudeleittechnik und Energiemanagement gewährleistet.

Technische Kennwerte

Messeingang

Eingangsnennspannung U_N	3 x 230/400 V AC Spannungsbereich: -20 % ... +15 %
Messbereich	10(60) A oder 10(100) A
Anlaufstrom	40 mA
Nennfrequenz f_N	50 Hz Frequenzbereich: 45 ... 55 Hz
Eigenverbrauch	< 0,6 W / Phase
S0 Schnittstelle nach EN 62053-31	
Impulswertigkeit	800 Impulse pro kWh
Maximalspannung	27 V DC
Strom	10 ... 27 mA

Anzeige

LCD-Anzeige	Größe 2,0 x 4 mm, 7-stellig, eine Dezimalstelle (000000,0 kWh)
Weitere Anzeigedaten	LED A B C, Blinkanzeige bei Falschanschluss

Weitere Informationen

Genauigkeitsklasse	1
Vorsicherung	max. 100 A
Gewicht	400 g
Montage	Hutschiene nach EN 60715
Einsatztemperatur	-25 ... +55 °C
Anschluss S0 Impuls	2,5 x 3 mm
Anschluss Messeingang	7 x 8 mm

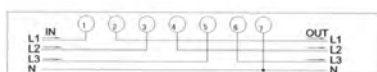
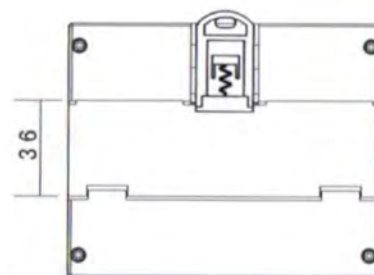
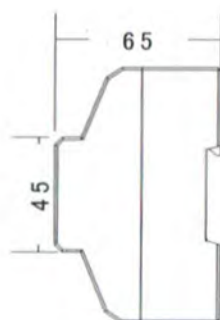
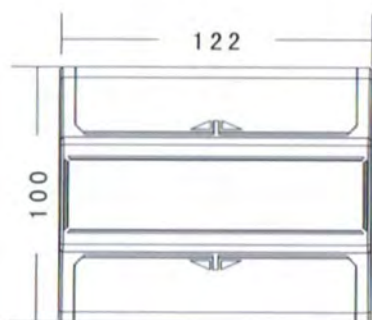

Best.-Nr.	S0 Impulsausgang	Elektromechanische Anzeige	LCD-Anzeige	Strombereich in A
ECP115110060	•		•	60
ECP115110100	•		•	100



ECP 1155

3-Phasen Energiewandlerzähler



Merkmale / Nutzen

- 5 A Stromwandleranschluss bis 6000/5 A
- Genauigkeitsklasse 1
- Übersetzungsverhältnis einstellbar
- S0 Impulsausgang

Anwendung

Elektronischer Energiezähler zur Erfassung der elektrischen Wirkenergie in Drehstromnetzen.

Der Energiezähler findet Anwendung in Industrieunternehmen, im Schaltanlagenbau, im Gewerbe sowie bei Privatnutzern.

Mit dem S0 Impulsausgang ist die Weiterverarbeitung der gemessenen Energiedaten, wie z. B. für die Kostenstellenabrechnung, Gebäudeleittechnik und Energiemanagement gewährleistet.

Technische Kennwerte

Messeingang	
Eingangsnennspannung U_N	3 x 230/400 V AC Spannungsbereich: -20 % ... +15 %
Messbereich	1,5(6) A programmierbare Wandler- Übersetzungsverhältnisse zur Direktablesung
Anlaufstrom	3 mA
Nennfrequenz f_N	50 Hz
Eigenverbrauch	< 0,7 W/Phase
S0 Schnittstelle nach EN 62053-31	
Impulswertigkeit	12000 Impulse pro kWh bei der Übersetzung 5/5 A, bei anderen Übersetzungen siehe Tabelle Übersetzungsverhältnisse
Maximalspannung	30 V DC

Minimalspannung	5 V DC
Strom	20 mA
Anzeige	
LCD-Anzeige	Größe 4,0 x 10 mm, 8-stellig, Anzeige entsprechend Bestelltabelle
Weitere Anzeigedaten	LED A B C, Blinkanzeige bei Falschanschluss
Weitere Informationen	
Genauigkeitsklasse	1
Vorsicherung	6 A
Gewicht	350 g
Montage	Hutschiene nach EN 60715
Einsatztemperatur	-20 ... +55 °C
Anschluss S0 Impuls	1 mm ²
Anschluss Messeingang	6 mm ²

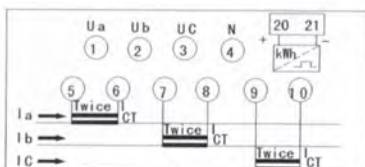
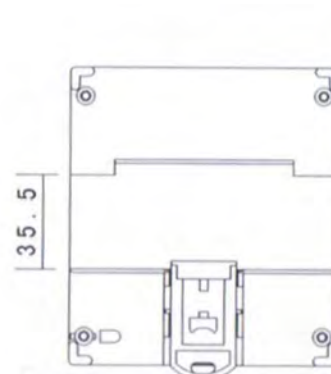
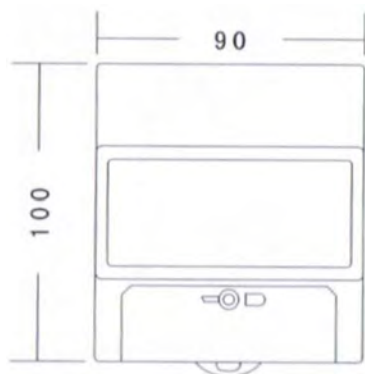



Bestelltabelle

Best.-Nr.	Wandler- übersetzung primär	Wandler- übersetzung sekundär	Faktor	Zählerimpuls	Ausgangs- impulse pro kWh	Digital- anzeige Stellen	Anzeige in kWh
ECP11550005-A	5	5	1	12000	12000	6+2	999999,99
ECP11550010-A	10	5	2	12000	6000	6+2	999999,99
ECP11550020-A	20	5	4	12000	3000	6+2	999999,99
ECP11550025-A	25	5	5	12000	2400	6+2	999999,99
ECP11550040-A	40	5	8	12000	1500	6+2	999999,99
ECP11550050-A	50	5	10	12000	1200	6+2	999999,99
ECP11550060-A	60	5	12	12000	1000	6+2	999999,99
ECP11550075-A	75	5	15	12000	800	7+1	9999999,9
ECP11550080-A	80	5	16	12000	750	7+1	9999999,9
ECP11550100-A	100	5	20	12000	600	7+1	9999999,9
ECP11550120-A	120	5	24	12000	500	7+1	9999999,9
ECP11550150-A	150	5	30	12000	400	7+1	9999999,9
ECP11550200-A	200	5	40	12000	300	7+1	9999999,9
ECP11550250-A	250	5	50	12000	240	7+1	9999999,9
ECP11550300-A	300	5	60	12000	200	7+1	9999999,9
ECP11550400-A	400	5	80	12000	150	7+1	9999999,9
ECP11550500-A	500	5	100	12000	120	7+1	9999999,9
ECP11550600-A	600	5	120	12000	100	7+1	9999999,9
ECP11550800-A	800	5	160	12000	75	8+0	99999999
ECP11551000-A	1000	5	200	12000	60	8+0	99999999
ECP11551200-A	1200	5	240	12000	50	8+0	99999999
ECP11551500-A	1500	5	300	12000	40	8+0	99999999
ECP11552000-A	2000	5	400	12000	30	8+0	99999999
ECP11552500-A	2500	5	500	12000	24	8+0	99999999
ECP11553000-A	3000	5	600	12000	20	8+0	99999999
ECP11554000-A	4000	5	800	12000	15	8+0	99999999
ECP11555000-A	5000	5	1000	12000	12	8+0	99999999
ECP11556000-A	6000	5	1200	12000	10	8+0	99999999

- **Einstellung auf das Wandler-Übersetzungsverhältnis**

- Parametriertaste gedrückt halten und Spannung an Klemmen 1 und 4 anlegen (Anzeige 0005 5).
- Zähleranzeige geht in den Übersetzungsmodus.
- Parametriertaste zum Weiterschalten auf weitere Übersetzungsverhältnisse drücken.
- Beim gewünschten Übersetzungsverhältnis die Parametriertaste 10 Sekunden drücken bis die kWh-Anzeige erscheint.
- Beispiel: Anzeige 0080 5, Parametriertaste gedrückt halten, Anzeige 0100 5, nach 10 Sekunden erscheint die Energieanzeige, 100/5 A ist programmiert.
- **Laufender Betrieb:** Abwechselnde Darstellung von Übersetzungsverhältnis und Energiewerte.
- **Das Wandlerverhältnis kann nur einmalig eingestellt werden.**



Auf den folgenden Seiten finden Sie Energiezähler, Datenlogger und Software von der schweizer Firma EMU AG, Baar. Die MBS AG ist die Exklusivvertretung für Deutschland.

Die Ware wird zu 100% in der Schweiz entwickelt und produziert.

Wir garantieren damit kurze Wege und zukunftsweisende Technologie in MID-Ausführung.

Mit den Energiezählern „Allrounder“ und „Professional“ werden neue Maßstäbe in der Komplexität der Datenerfassung im Bereich der DIN-Hutschienen-Energiezähler gesetzt. Über die unterschiedlichsten Ausleseschnittstellen lässt sich eine Vielzahl von Messwerten übertragen. Die Geräte bieten Ihnen ein höchstes Maß an Flexibilität.

- Wandleranschluss 1 A und 5 A
- Direktanschluss bis 75 A
- vor Ort direkt einstellbar: Wandlerverhältnis, Impulsrate, Impulszeit
- Baubreite von 5 TE (90 mm)
- Geringer Eigenverbrauch
- MID-Zulassung

Profitieren auch Sie von der hervorragenden Qualität „Made in Switzerland“.

Qualität verbindet sich!



Energiezähler mit MID-Zulassung, Energiezähler-Zubehör

MBS Allrounder	374
MBS Professional	376
S0 Impuls-Logger	384
M-Bus-Logger	385
Software	386
Fronttafeleinbaurahmen	387



MBS „Allrounder“

3-Phasen Energiezähler



Merkmale / Nutzen

- Direktanschluss bis 75 A oder Stromwandleranschluss für x/1 A und x/5 A (bis zu 4000/1 A und 20000/5A)
- Genauigkeitsklasse B gemäß EN 50470-1 (MID)
- Genauigkeitsklasse 1 gemäß EN 62053-21
- MID Zulassung Modul B und D für Verrechnungszwecke
- zur Verrechnung einsetzbar
- S0 Impulsausgang
- Mehrtarif
- Optionale M-Bus Ausleseschnittstelle

Anwendung

Elektronischer Energiezähler zur Erfassung der elektrischen Wirkenergie in Wechselstromnetzen.

Der Energiezähler findet Anwendung in Industrieunternehmen, im Schaltanlagenbau, im Gewerbe sowie bei Privatnutzern.

Mit dem S0 Impulsausgang und optionalen Schnittstellen ist die Weiterverarbeitung der gemessenen Energiedaten, wie z. B. für die Kostenstellenabrechnung, Gebäudeleittechnik und Energiemanagement gewährleistet.

Technische Kennwerte

Messeingang	
Eingangsnennspannung U_N	3 x 230/400 V AC Spannungsbereich: $\pm 20\%$
Messbereich (Direktanschluss)	0,012 ... 75 A
Messbereich (Stromwandleranschluss)	1 und 5 A, Wandlerverhältnis einstellbar
Anlaufstrom (Direktanschluss)	9 mA
Anlaufstrom (Stromwandleranschluss)	1 mA
Nennfrequenz f_N	50 Hz Frequenzbereich: 45 ... 65 Hz
Eigenverbrauch	< 0,8 W / Phase
Tarumschaltung	230 V AC
S0 Schnittstelle nach EN 62053-31	
Impulslänge (Direktanschluss)	40 ms (werkseitige Einstellung)
Impulslänge (Stromwandleranschluss)	120 ms (werkseitige Einstellung)
Impulswertigkeit (Direktanschluss)	1000 Impulse pro kWh (werkseitige Einstellung)
Impulswertigkeit (Stromwandleranschluss)	10 Impulse pro kWh (werkseitige Einstellung)
	Impulsrate und Impulslänge am Zähler individuell einstellbar
Minimalspannung	5 V DC

Maximalspannung	600 V AC
Strom	max. 90 mA
Anzeige	
LCD-Anzeige	Größe 60 x 30 mm, Anzeige 8-stellig, eine Dezimalstelle (000000,0 kWh)
Weitere Anzeigedaten	Aktiver Tarif, Drehfeld-Anzeige, Energierichtung, momentane Leistung
Messausgang	
Optionale Ausleseschnittstellen	M-Bus
Weitere Informationen	
Genauigkeitsklasse	B (gemäß EN 50470-1, MID)
Vorsicherung (Direktanschluss)	max. 80 A
Vorsicherung (Stromwandleranschluss)	max. 6 A
Schutzklasse	II
Schutzart	IP 20
Gewicht	330 g
Montage	Hutschiene nach EN 60715
Einsatztemperatur	-25 ... +55 °C
Anschluss Tarumschaltung	2,5 x 3 mm
Anschluss S0 Impuls	2,5 x 3 mm
Anschluss Messeingang	7 x 8 mm



Bestelltabelle

Best.-Nr.	S0 Impulsausgang	M-Bus Ausgang	LCD-Anzeige	Strombereich in A
EMA4176-4	•		•	75
EMA4776-4	•	•	•	75
EMA4177-2	•		•	1 und 5
EMA4777-2	•	•	•	1 und 5

Anzeigedaten

	Summe 3-Phase	Pro Phase	Je Tarif
Wirkenergie Bezug (kWh)	•		•
Wirkenergie Bezug (kWh) rückstellbar	•		•
Wirkleistung (kW)	•	•	
Strom (A)	•	•	
Spannung (V) L-N		•	
Anzahl Spannungsausfälle	•		

Schnittstellenprotokolle stehen auf unserer Homepage zum Download bereit.

Maße

Direktanschluss

Direktanschluss mit M-Bus

Stromwandleranschluss

Stromwandleranschluss mit M-Bus



MBS „Professional“

3-Phasen Energiezähler



Merkmale / Nutzen

- Direktanschluss bis 75 A oder Stromwandleranschluss für x/1 A und x/5 A (bis zu 4000/1 A und 20000/5A)
- Genauigkeitsklasse B gemäß EN 50470-1 (MID)
- Genauigkeitsklasse 1 gemäß EN 62053-21
- MID Zulassung Modul B und D für Verrechnungszwecke
- zur Verrechnung einsetzbar
- 4 S0 Impulsausgänge
- Mehrtarif
- Optionale Ausleseschnittstellen: M-Bus, KNX, TCP/IP, LON oder MODBUS RTU-ASCII

Anwendung

Elektronischer Energiezähler zur Erfassung der elektrischen Wirkenergie in Wechselstromnetzen.

Der Energiezähler findet Anwendung in Industrieunternehmen, im Schaltanlagenbau, im Gewerbe sowie bei Privatnutzern.

Mit dem S0 Impulsausgang und optionalen Schnittstellen ist die Weiterverarbeitung der gemessenen Energiedaten, wie z.B. für die Kostenstellenabrechnung, Gebäudeleittechnik und Energiemanagement gewährleistet.

Technische Kennwerte

Messeingang	
Eingangsnennspannung U_N	3 x 230/400 V AC Spannungsbereich: $\pm 20\%$
Messbereich (Direktanschluss)	0,012 ... 75 A
Messbereich (Stromwandleranschluss)	1 und 5 A, Wandlerverhältnis einstellbar
Anlaufstrom (Direktanschluss)	9 mA
Anlaufstrom (Stromwandleranschluss)	1 mA
Nennfrequenz f_N	50 Hz Frequenzbereich: 45 ... 65 Hz
Eigenverbrauch	< 0,8 W / Phase
Tarifumschaltung	230 V AC
S0 Schnittstelle nach EN 62053-31	
Impulslänge (Direktanschluss)	40 ms (werkseitige Einstellung)
Impulslänge (Stromwandleranschluss)	120 ms (werkseitige Einstellung)
Impulswertigkeit (Direktanschluss)	1000 Impulse pro kWh (werkseitige Einstellung)
Impulswertigkeit (Stromwandleranschluss)	10 Impulse pro kWh (werkseitige Einstellung)
	Impulsrate und Impulslänge am Zähler individuell einstellbar
Minimalspannung	5 V DC oder 5 V AC

Maximalspannung	600 V AC
Strom	max. 90 mA
Anzeige	
LCD-Anzeige	Größe 60 x 30 mm, Anzeige 8-stellig, eine Dezimalstelle (0000000,0 kWh)
Weitere Anzeigedaten	Aktiver Tarif, Drehfeld-Anzeige, Energierichtung, momentane Leistung
Messausgang	
Optionale Ausleseschnittstellen	M-Bus, KNX, TCP/IP, LON, MODBUS RTU-ASCII
Weitere Informationen	
Genauigkeitsklasse	B (gemäß EN 50470-1, MID)
Vorsicherung (Direktanschluss)	max. 80 A
Vorsicherung (Stromwandleranschluss)	max. 6 A
Schutzklasse	II
Schutzart	IP 20
Gewicht	330 g
Montage	Hutschiene nach EN 60715
Einsatztemperatur	-25 ... +55 °C
Anschluss Tarifumschaltung	2,5 x 3 mm
Anschluss S0 Impuls	2,5 x 3 mm
Anschluss Messeingang	7 x 8 mm



Bestelltabelle

Best.-Nr.	S0 Impuls- ausgang	M-Bus	KNX	TCP/IP	LON	MODBUS RTU-ASCII	LCD-An- zeige	Strombe- reich in A
EMP4176-4	4x						•	75
EMP4776-4	4x	•					•	75
EMP4576-4	4x		•				•	75
EMP4676-4	4x			•			•	75
EMP4076-4	4x				•		•	75
EMP4276-4	4x					•	•	75
EMP4177-2	4x						•	1 und 5
EMP4777-2	4x	•					•	1 und 5
EMP4577-2	4x		•				•	1 und 5
EMP4677-2	4x			•			•	1 und 5
EMP4077-2	4x				•		•	1 und 5
EMP4277-2	4x					•	•	1 und 5

Anzeigedaten

	Summe 3-Phase	Pro Phase	Min. Messwert	Max. Messwert	Je Tarif
Wirkenergie Bezug (kWh)	•	•			•
Wirkenergie Lieferung (kWh)	•				•
Blindenergie induktiv (KVArh)	•	•			•
Blindenergie kapazitiv (KVArh)	•				•
Wirkleistung (kW)	•	•	•	•	
Blindleistung (kVAr)	•	•			
Scheinleistung (kVA)	•	•			
Strom (A)	•	•	•	•	
Spannung (V) L-N		•	•	•	
Spannung (V) L-L		•			
Leistungsfaktor (cos phi)		•			
Netzfrequenz (Hz)	•				
Anzahl Spannungsausfälle	•				
Laufendes x Min. Maximum (kW) *					•
x Min. Wirkleistungsmaximum					•
Datum / Uhrzeit	•				

* Messperiode 1, 5, 15, 30 oder 60 Minuten

Schnittstellenprotokolle stehen auf unserer Homepage zum Download bereit.



Maße

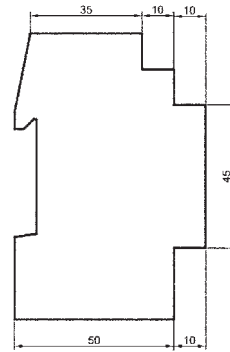
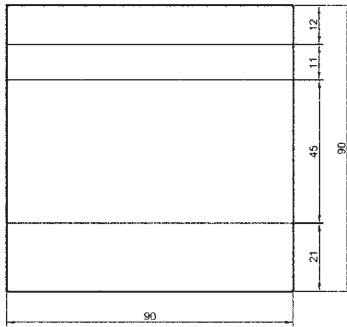

Direktanschluss

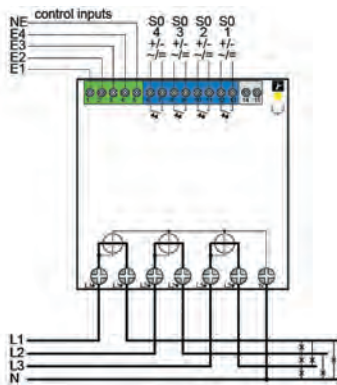

Direktanschluss mit M-Bus

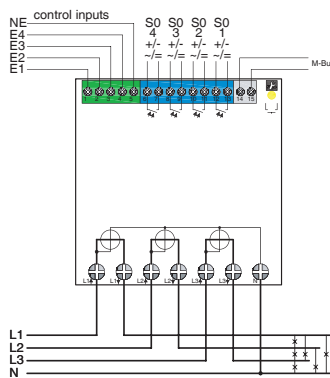

Direktanschluss mit TCP/IP

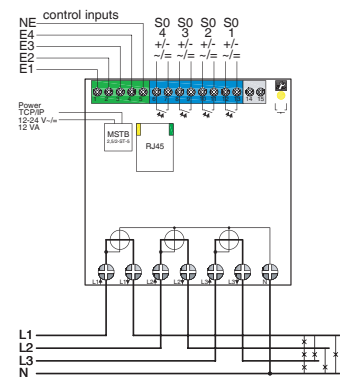

Direktanschluss mit KNX

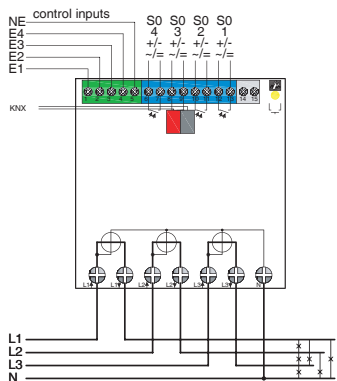

Direktanschluss mit LON

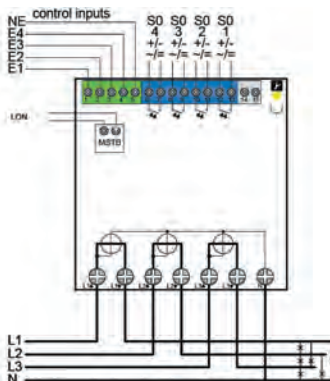

Direktanschluss mit Modbus

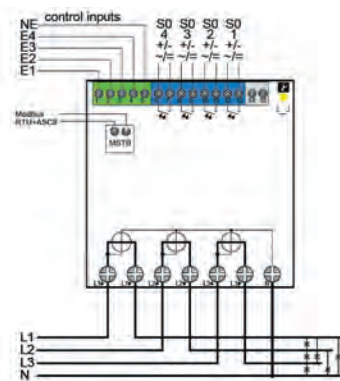



Maße

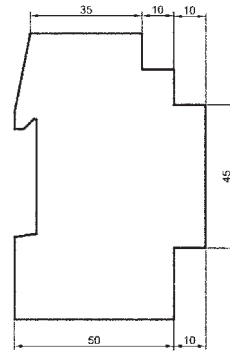
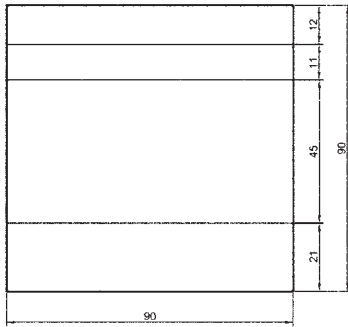

Stromwandleranschluss

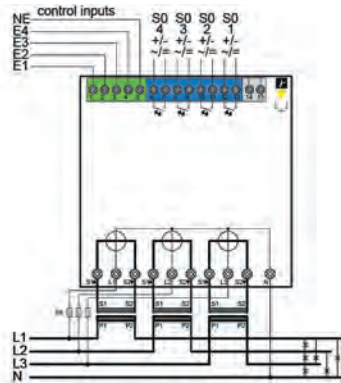

Stromwandleranschluss mit M-Bus

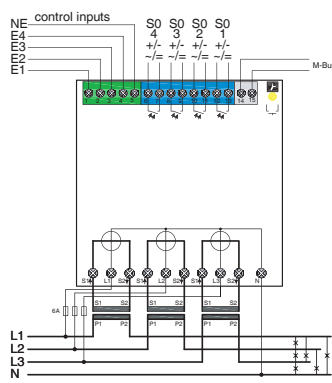

Stromwandleranschluss mit TCP/IP

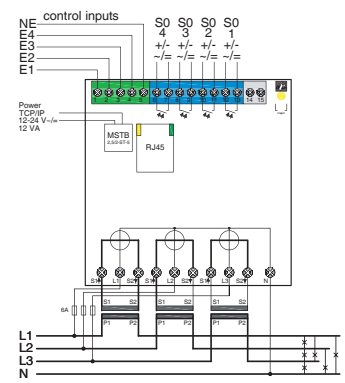

Stromwandleranschluss mit KNX

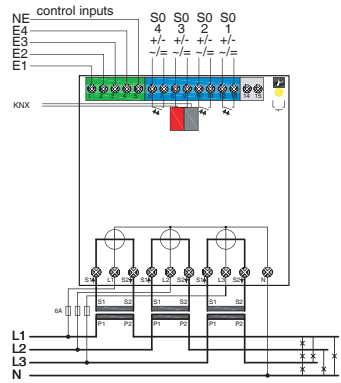

Stromwandleranschluss mit LON

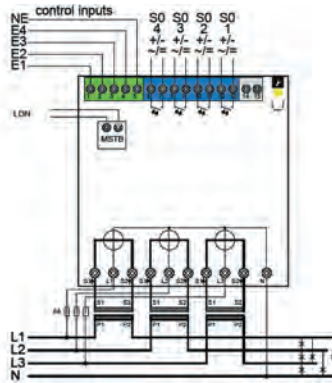

Stromwandleranschluss mit Modbus

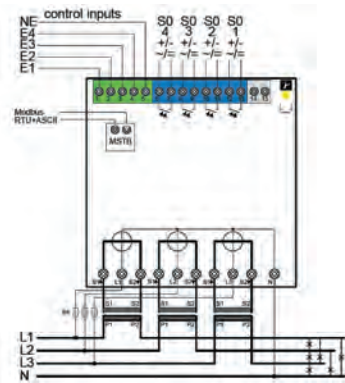



Technische Details

zu dem MBS „Allrounder“ und MBS „Professional“

Bedienung & Display

Ein 60x30 mm großes grafisches LC-Display mit einer LED-Hintergrundbeleuchtung ermöglicht das Ablesen von Parametern und Einstellungen bei hervorragender Sichtbarkeit der Ziffern.

Die gewünschte Menüsprache kann via Tasten ausgewählt werden.

Die übersichtliche und intuitive Bedienung erleichtert die Inbetriebnahme sowie die tägliche Arbeit mit den Energiezählern.

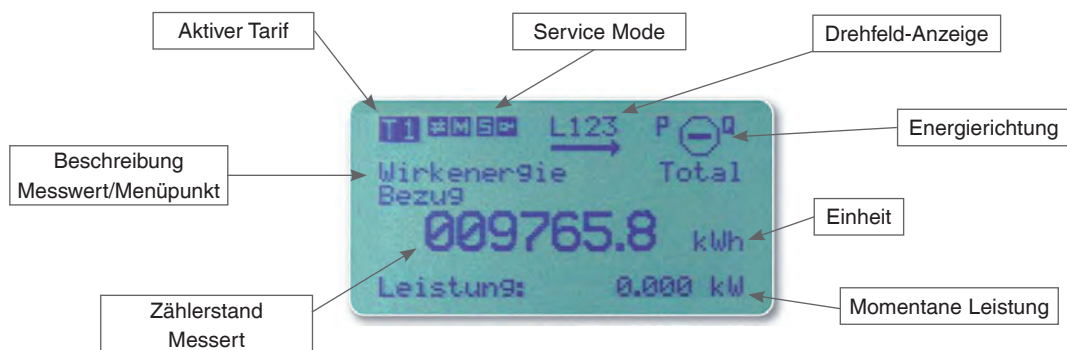

MID-Zulassung B + D

Der MBS „Allrounder“ und MBS „Professional“ sind nach MID-Modul B + D (Measurement Instrument Directive) geprüft und zugelassen.

Durch die zusätzliche Zertifizierung nach Modul D, QM-System für die Herstellung und Endprüfung, können Sie sämtliche MBS „Professional“ und MBS „Allrounder“ ab Werk für Verrechnungszwecke innerhalb der Europäischen Union einsetzen.

Eich- und Last-LED

Auf der Frontseite des MBS „Professional“ und des MBS „Allrounder“ finden Sie zwei rote Eich- und Last-LED.

Sie blinken abhängig von der vorhandenen Wirk- und Blindleistung.

Die Impulswertigkeit beträgt 10 Impulse pro Wh/varh.

Stromwandlerfaktor einstellbar

Das Stromwandlerverhältnis kann beim MBS „Professional“ und beim MBS „Allrounder“ mit MID-Zulassung via Tasten von 5/5 A bis 20.000/5 A oder 1/1 A bis 4.000/1 A eingestellt werden.

Die Setup-Taste ist plombierbar und verhindert Manipulationen.

Um einen S0-Dauerimpuls zu verhindern, steht Ihnen das MBS-Team gerne mit Rat und Tat zur Seite.

Genauigkeit bei Photovoltaik-Anlagen



Der MBS „Professional“ und der MBS „Allrounder“ wurden speziell für den Einsatz mit Wechselrichtern bei Photovoltaik-Anlagen geprüft.

Die zusätzliche Prüfung garantiert, dass die MBS Energiezähler im nicht regulierten Frequenzbereich zwischen 2 kHz und 150 kHz ein exaktes Messergebnis liefern.

Renommierte Fachzeitschriften berichten über diese Problematik, dass Messfehler von bis zu 18% auftreten können.



Peak Control

über S0 Impulsausgang

Die Energieversorger wünschen sich einen planbaren und gleichmäßigen Energieverbrauch.

Um kurzfristige Verbrauchsspitzen abzudecken, wurden Leistungstarife eingeführt. Diese basieren auf dem höchsten monatlichen Viertelstunden-Wirkleistungsspitzenwert.

Die Spitzenwerte führen in Hotels, Krankenhäusern und in der Industrie zu massiv erhöhten Energiekosten. Hier greift der EMU Professional ein und reduziert die Leistung ausgewählter Verbraucher.

Umgehend werden die Spitzenwerte optimiert und die Energiekosten gesenkt.

Funktionsweise

Die S0-Ausgänge (Opto Power MOSFET 5–600V AC oder V DC, 90 mA) können als Schaltkontakte verwendet werden. Wird ein bestimmter Schwellwert für eine definierte Zeit überschritten, wird der Schaltkontakt für eine gewisse Zeit aktiviert.

Lastgang im Tagesverlauf

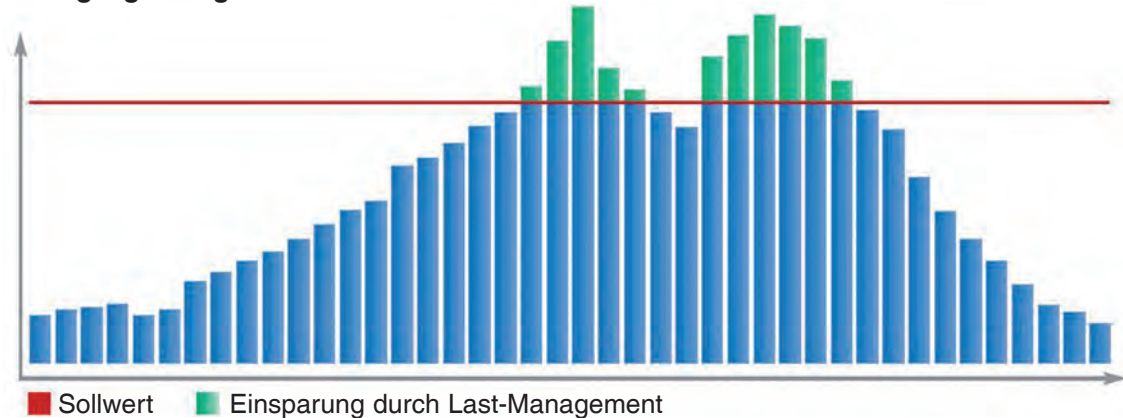

Anwendung

- Reduzierung der Energiekosten durch Vermeidung von Wirkleistungsspitzen
- Alarmierung bei drohender Überlastung, Maximum-Wächter
- Energierichtungs-Kontakt
- Vermeidet Überlastungen und Produktionsunterbrechungen
- Photovoltaik-Anlagen, Industrie, Gastronomie, energieintensive Verbraucher

S0 Impulsausgänge

Die 4 S0 Impulsausgänge des MBS Professional können in Verbindung mit dem TCP/IP-Modul als Schalter verwendet werden, um damit ein Relais ein- oder auszuschalten.

Damit können Sie beispielsweise die Heizung in Ihrem Ferienhaus aktivieren.

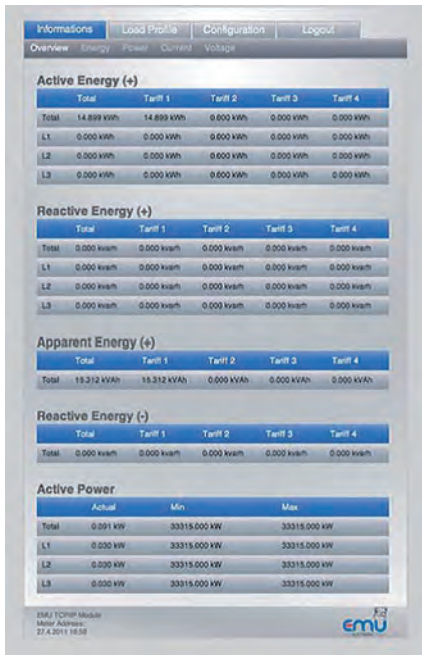

TCP/IP-Modul des Energiezählers MBS „Professional“

Merkmale / Nutzen

- Preiswert
- Einfacher und bequemer Zugriff über Webbrowser
- Kontinuierliche Überwachung und Analyse der Messdaten
- Einfache Installation

Mit dem TCP/IP-Modul analysieren Sie via Webbrowser und IP-Adresse in einem LAN oder WAN unterschiedliche Messwerte und ein Lastprofil. Das Modul loggt Messwerte in einem konfigurierbaren Intervall und exportiert sie in eine CSV-Datei (Comma-Separated Values).

Das integrierte Warnsystem alarmiert Sie per E-Mail (oder E-Mail to SMS Gateway) zuverlässig über die Über- oder Unterschreitung eines definierten Messwertes.

Die S0-Impulsausgänge (Opto Power MOSFET, 600V AC oder V DC, 90 mA) lassen sich als Schalter umfunktionieren und können beispielsweise ein Relais ansteuern, um die Heizung im Ferienhaus zu aktivieren.

Funktionen

- Anzeigen der aktuellen Messwerte
- Anzeigen eines grafischen Lastprofils
- Loggen von unterschiedlichen Messwerten
- Anzeigen von Minimum und Maximum eines Messwertes
- Alarmierung per E-Mail beim Unter- oder Überschreiten eines Messwertes
- Ein-/Ausschalten von S0-Ausgängen
- Zugriffsschutz mit Passwort
- Fernauslesung via Modbus TCP und BACnet IP

Integriertes Warnsystem

Ein Warnsystem alarmiert Sie zuverlässig, auch unterwegs, über den Energieverbrauch Ihrer Firma. Wird ein definierter Messwert überschritten, erhalten Sie eine Nachricht per E-Mail oder SMS. Beispielsweise werden Sie alarmiert, wenn die Stromaufnahme der Heizung unter einen definierten Wert fällt.

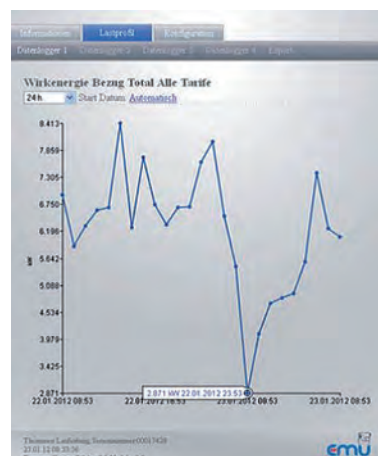

Datenlogger

Das TCP/IP-Modul speichert vier konfigurierbare Messwerte im Intervall von 10 Sekunden, 5, 15, 30 oder 60 Minuten.

Im TCP/IP-Modul können bis zu 245.000 Werte gespeichert werden. Sämtliche Werte werden aufgezeichnet und bleiben gespeichert, auch wenn der MBS Professional nicht am LAN-Netz angeschlossen ist.



M-Bus Schnittstelle und MB-Connect Software

Die M-Bus Schnittstelle nach EN13757-2, -3 (vormals EN1434-3) ist im Energiezähler integriert und vor Verschmutzung und Manipulation geschützt.

Auslesedaten und Konfiguration

Am M-Bus stehen Ihnen eine Vielzahl von Auslesedaten wie Wirk- und Blindenergie, Strom, Spannung, Formfaktor und Netzfrequenz zur Verfügung.

Über die Bedientasten am Energiezähler lassen sich Primär- sowie Sekundäradresse und Baudrate einstellen.

Die Auslesedaten können mit unserer kostenlosen MB-Connect Software parametrierbar werden. So können Sie sich Ihr individuelles M-Bus Protokoll zusammenstellen.

Die M-Bus Belastung des MBS Allrounder und MBS Professional beträgt 1.5 mA resp. eine Standardlast.



MB-Connect Software

Zur Konfiguration der Energiezähler mit M-Bus Schnittstelle steht auf unserer Website die kostenlose MB-Connect Software zur Verfügung.

Alle Energiezähler mit einer M-Bus Schnittstelle nach EN13757 lassen sich mit der MB-Connect konfigurieren und auslesen.

Die Auslesung erfolgt manuell oder periodisch in einem einstellbaren Intervall.

Die ausgelesenen Werte können in eine CSV-Datei (Comma-Separated Values) exportiert und zum Beispiel in Excel aufbereitet werden.

Wünschen Sie für Ihr Projekt spezielle Auslesedaten?

Kein Problem. Erstellen Sie mit der MB-Connect ein M-Bus Parameter-Set und geben dies bei der Bestellung an.

Während der Produktion parametrieren wir für Sie die gewünschten Auslesedaten.

Funktionen

- Überprüfung einer M-Bus Installation
- Adressierung der Zähler
- Setzen individueller Auslesedaten
- Umstellung der Baudrate
- Auswertung der Antwortzeiten
- Automatische Zählerauslesung
- Export der Auslesedaten in CSV-Datei
- Ein- und Ausschalten der S0-Ausgänge

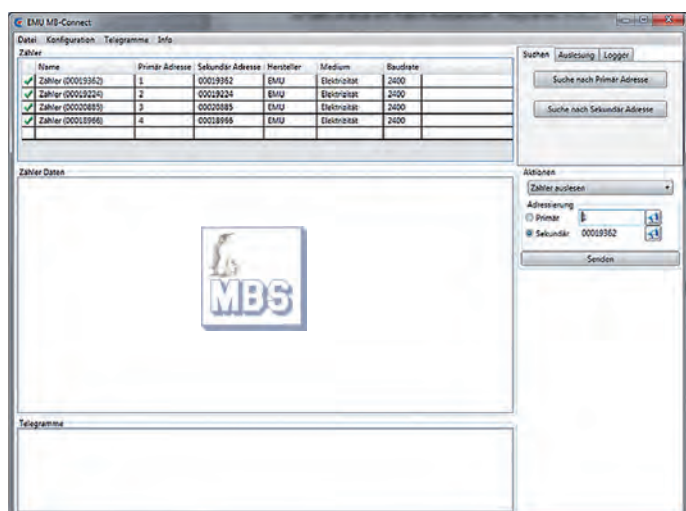



S0 Impuls-Logger



(Abbildung ähnlich)

Merkmale / Nutzen

- Einfacher und bequemer Zugriff über Webbrowser
- Kontinuierliche Überwachung und Analyse der Messdaten
- Einfache Installation
- Herstellerunabhängiges System
- Anschluss von bis zu 9 Zählern und zwei Temperatursensoren

Anwendung

Ein sinnvolles Gebäudemanagement ist nur dann möglich, wenn alle entsprechenden Verbrauchswerte kontinuierlich erfasst werden. Mit dem S0 Impuls-Logger ist das auf eine sehr einfache Art und Weise möglich. Der Impuls-Logger nutzt dabei die S0 Impuls-Schnittstelle von Wasserzählern, Wärmemengenzählern, Energiezählern, Gaszählern. Zusätzlich ist es möglich, die Außen- und Innentemperatur zu überwachen. Alles, was man benötigt, ist ein Notebook (PC) mit einem RJ45 (LAN) Anschluss und installiertem Webbrowser (Internet Explorer, Mozilla Firefox o.ä.).

Technische Kennwerte

Schnittstellen	
S0 Impuls-Eingang	9x
Temperatur-Eingang	2x
Auslese-Anschluss	RJ45 (LAN)
Daten	
Auswertung	Via Webbrowser und IP-Adresse (Fixe IP oder DynDNS für Fernzugriff)
Log-Intervall	10 Sekunden, 1, 5, 15, 30 und 60 Minuten
Speicher	2 GB Micro SD Karte, Karte herausnehmbar 8 Millionen Log-Einträge (alle Eingänge belegt: 20 Jahre)

Daten-Export	Via Website in CSV-Datei
Datenerhalt bei Spannungsausfall	Ja (Micro SD Karte)
Spannungsversorgung	
S0 Impuls-Logger	230 V AC
S0 Impuls-Ausgang der Zähler	Der Impuls-Logger generiert 13 V DC
Weitere Informationen	
Schutzart	IP 20
Montage	Hutschiene nach EN 60715

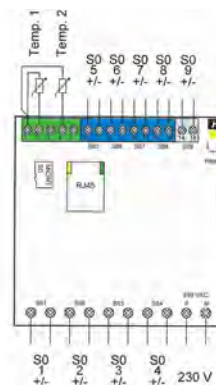
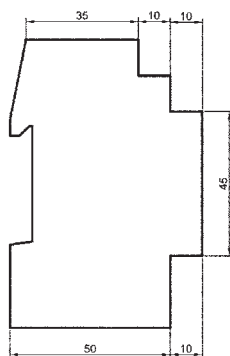
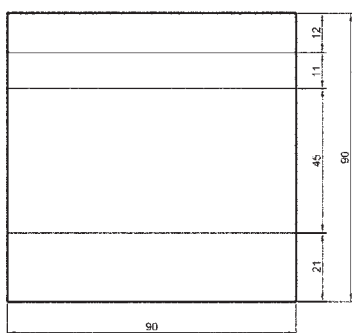

Best.-Nr.	Beschreibung
EMI6	S0 Impuls-Logger mit 9 S0 Impulseingängen und 2 Temperatureingängen
EMT	Temperatursensor für S0 Impuls-Logger (-55 ... +155 °C)



M-Bus-Logger



(Abbildung ähnlich)

Merkmale / Nutzen

- Einfacher und bequemer Zugriff über Webbrowser
- Kontinuierliche Überwachung und Analyse der Messdaten
- Einfache Installation
- Herstellerunabhängiges System
- Anschluss von bis zu 60 M-Bus Endgeräten

Anwendung

Ein sinnvolles Gebäudemanagement ist nur dann möglich, wenn alle entsprechenden Verbrauchswerte kontinuierlich erfasst werden. Mit dem M-Bus-Logger ist das auf eine sehr einfache Art und Weise möglich. Der M-Bus-Logger nutzt dabei die M-Bus-Schnittstelle von Wasserzählern, Wärmemengenzählern, Energiezählern, Gaszählern. Alles, was man benötigt, ist ein Notebook (PC) mit einem RJ45 (LAN) Anschluss und installiertem Webbrowser (Internet Explorer, Mozilla Firefox o.ä.). Damit können Sie auf der Website des Energiezählers (Zugriff über IP-Adresse des Zählers) die gewünschten Messwerte inkl. Lastprofil ansehen. Dank des integrierten Webservers benötigen Sie keine spezielle Auslesesoftware und können die Daten von jedem beliebigen PC, Notebook, Tablet PC oder Smartphone ansehen.

Technische Kennwerte

Schnittstellen	
M-Bus-Eingang	60x
Auslese-Anschluss	RJ45 (LAN)
Daten	
Auswertung	Via Webbrowser und IP-Adresse (Fixe IP oder DynDNS für Fernzugriff)
Log-Intervall	10 Sekunden, 1, 5, 15, 30 und 60 Minuten, 6, 12, 24 Stunden

Speicher	2 GB Micro SD Karte, Karte herausnehmbar ca. 5 Millionen Zählerauslesungen / M-Bus-Telegramme
Daten-Export	Via Website in CSV-Datei
Datenerhalt bei Spannungsausfall	Ja (Micro SD Karte)
Spannungsversorgung	
M-Bus-Logger	100 ... 240 V AC
Weitere Informationen	
Schutzart	IP 20
Montage	Hutschiene nach EN 60715

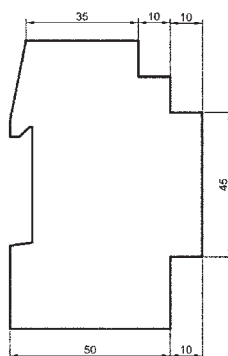
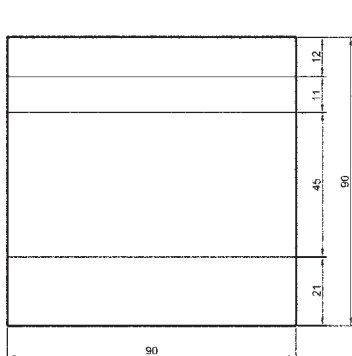

Best.-Nr.	Beschreibung
LM620000	M-Bus-Logger 60 TCP/IP (Webserver, FTP Upload) für den Anschluss von bis zu 60 Endgeräten

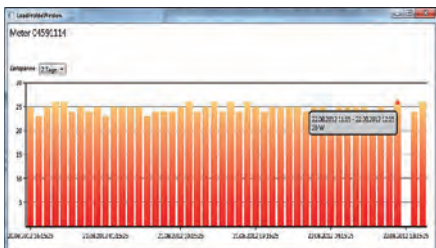

MBS Bill & Report

Die benutzerfreundliche MBS Bill & Report Software generiert kundenspezifische Abrechnungen und Reports auf Knopfdruck. Die Verbrauchsdaten werden aus dem MBS M-Bus-Logger ausgelesen und verarbeitet.

Funktionen

- Verwaltung von allen Energiezählern, die an einen MBS M-Bus-Logger angeschlossen sind
- Anzeigen aller Messwerte eines Zählers
- Lastprofil für alle Energiewerte, Balkendiagramm
- Erstellen von Virtuellen Zählern, Summe von anderen Zählern
- Erstellen einer Verbrauchsübersicht pro Zähler, Start und Endzeit frei wählbar
- Zuordnen von Zählern und Virtuellen Zählern zu Kostenstellen
- Erstellung von Rechnungen für Kostenstellen, Zeitraum frei wählbar
- Kein Online-(24h-)Betrieb nötig, Messwerte werden vom MBS M-Bus-Logger ausgelesen, Software muss nicht durchgehend in Betrieb sein
- Individuelle Reports, Design und Rechnungen, erstellt von MBS, nach Aufwand

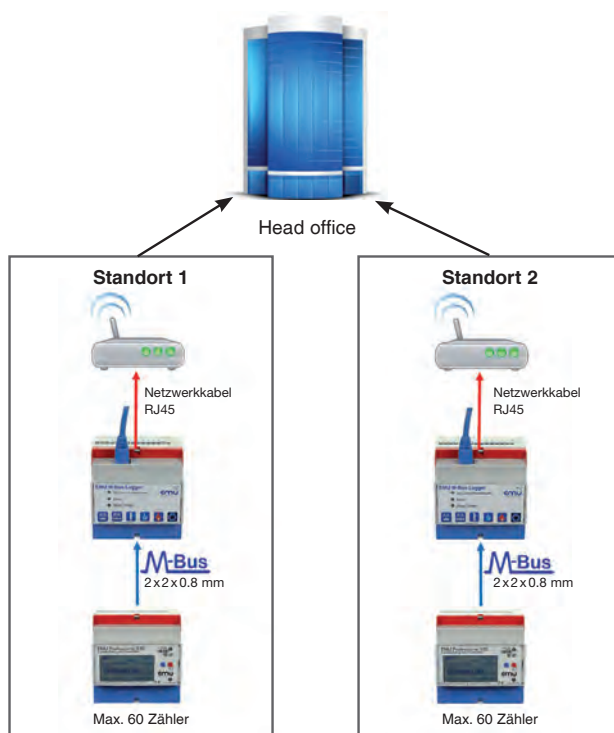
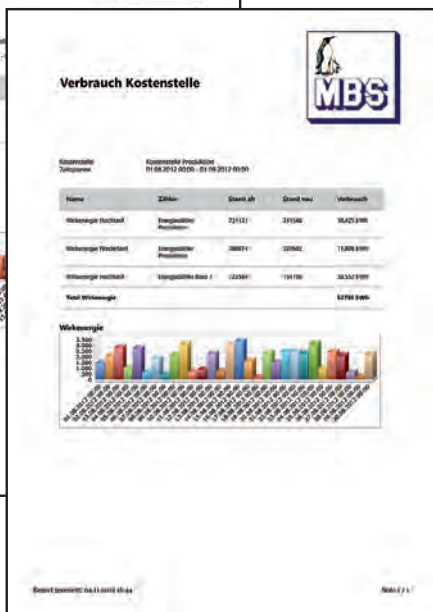

Bestelltablelle

Best.-Nr.	Beschreibung
SW1M000020	Bill & Report Software 20 – für 20 Energiezähler
SW1M000060	Bill & Report Software 60 – für 60 Energiezähler
SW1M000120	Bill & Report Software 120 – für 120 Energiezähler
SW1M000180	Bill & Report Software 180 – für 180 Energiezähler
SW1M000240	Bill & Report Software 240 – für 240 Energiezähler
SW1M000300	Bill & Report Software 300 – für 300 Energiezähler
SW1M000400	Bill & Report Software 400 – für 400 Energiezähler
SW1M000500	Bill & Report Software 500 – für 500 Energiezähler



smart-me

smart-me ist eine kostenlose Webapplikation mit der Verbrauchsdaten online ausgewertet und überwacht werden. Ob Elektrizität, Wasser, Gas oder Wärme, mit smart-me haben Sie Ihren Energieverbrauch im Griff.

Funktionen

- Automatisierte Datenverarbeitung
- Individuelles Benutzerkonto
- Schnelle und einfache Inbetriebnahme
- Unterstützt alle M-Bus Energiezähler
- Weltweiter Zugriff
- Detaillierte Auswertungen und Reports
- Export der Messdaten
- smart-me ist kostenlos!
- www.smart-me.com

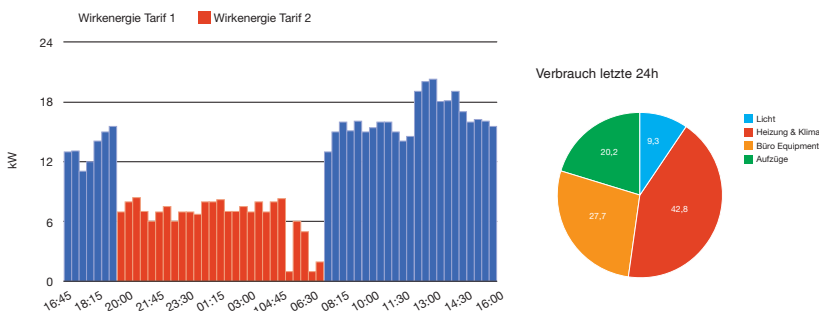

Ihre Vorteile

Mit smart-me verwalten Sie all Ihre weltweiten Messstellen und generieren Reports, Vergleiche und Analysen. Von Ihrem PC, Tablet oder Smartphone haben Sie weltweiten Zugriff auf Ihre Messwerte und Reports.

Funktionsweise

Messdaten werden vom MBS M-Bus-Logger, S0-Impuls-Logger und dem MBS „Professional“ TCP/IP via SML (Smart Meter Language) an den smart-me Server übertragen.

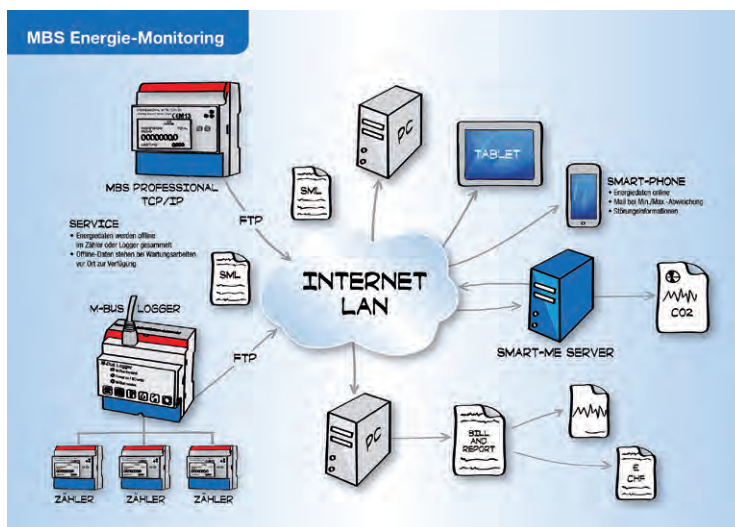

Typ ER



Typ KF

Fronttafelinbaurahmen

Best.-Nr.	Beschreibung
59501	ER Fronttüreinbausatz, 6 Teilungseinheiten Klappfenster KF selbstschließend, transparent, IP 44 mit Berührungsschutz und Montagehalterung
59502	KF Klappfenster, 2 Teilungseinheiten
59503	KF Klappfenster, 4 Teilungseinheiten
59504	KF Klappfenster, 6 Teilungseinheiten
59505	KF Klappfenster, 8 Teilungseinheiten
59506	Schlossgarnitur für KF, nachrüstbar



MBS AG





Schaltschrank-Heizungen und Regelgeräte

- Widerstandsheizung**
- Typ „LM-Big“
 - Typ „LM-Double“
 - Typ „S1 – S6 Sandwich“

-
- Gebälseheizungen**
- Typ „Varix 100“
 - Typ „Varix 250“
 - Typ „Vario“
 - Typ „HH“

-
- Regelgeräte**
- Thermostat Typ „TH-H“ Öffner – Typ „TH-K“ Schließer
 - Thermostat Typ „TH-WE“ Wechsler
 - Thermostat Typ „STH“ mit Fernfühler
 - Hygrostat Typ „HY/WE“
 - Hydrostat – Thermostat – Combination
Typ „HY/TH-H Combi“

-
- Zubehör**
- Schaltschrank-Steckdose

Schaltschrankheizungen

Anwendung – zur Verhinderung von Kondenswasser und als Frostwächter



Einsatzort

in allen Gehäusen, in denen es zu Kondenswasser / Frost kommen kann,
sind Schaltschrankheizungen notwendig

Schaltschrank



Pitch Systeme im Bereich Windkraft



Regelgeräte – zur Regelung von Heizgeräten, Filterlüftern, Wärmetauschern, Schalten von Signalgebern
bei Temperaturüberschreitung

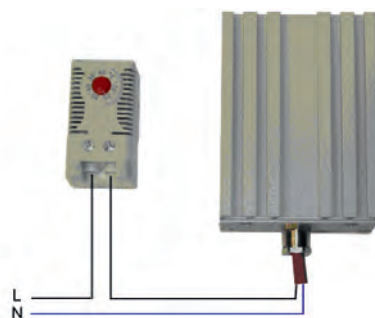



Widerstandsheizung

Typ „LM-Big“

Merkmale / Nutzen

- Gehäuse und Abstrahlkörper aus Aluminium, beidseitig profiliert
- Überzeugt durch besonders gute Wärmeabgabe
- Durch ausgeklügelte Anordnung der Kühlrippen, sowohl senkrecht als auch waagrecht einsetzbar
- Montage auf DIN Hutschiene EN 60715 oder wahlweise auch mit Schraubbefestigung
- Anschluss über 3 x 0,75 mm² Silikonkabel oder optional mit Anschlussstecker
- Mit internem Thermostat
- Hochwertige Kabelzugentlastung aus Messing vernickelt

Anwendung

Die Schaltschrankheizung des Typs „LM-Big“ ist durch die hohe Leistung besonders zum Einsatz in größeren elektrischen Steuerungs-, Schalt- und Regelanlagen sowie in Verteilerschränken geeignet und schützt diese vor zu geringen Temperaturen oder zu hoher Luftfeuchtigkeit.

Die Schaltschrankheizungen des Typs „LM-Big“ in Verbindung mit unseren Thermostaten und Hygrostaten garantiert die Verhinderung von Kondensatbildung innerhalb Ihrer Anlage.

Technische Kennwerte

Spannungen	
Spannungen (Heizwiderstand)	230 V AC/DC
Leistungen	
Leistungen	500 W
Maße / Gewichte	
Typ „LM-Big“	303 x 93 x 117 mm – 1356 g
Befestigung	
Befestigung	Clip für DIN Hutschiene EN 60715 (Standard) oder Schraubbefestigung

Sicherheit	
Schutzart	IP 52
Anschluss	
Anschluss	Silikonkabel 3 x 0,75 mm ² ; Länge 0,5 m (Standard) oder Anschlussstecker
Internes Thermostat	
Ein	ca. 28 °C (Geräteeigentemperatur)
Hysterese	40 K (± 7 K)
Lebensdauer	~ 100.000 Zyklen
Optional	Ohne internes Thermostat möglich

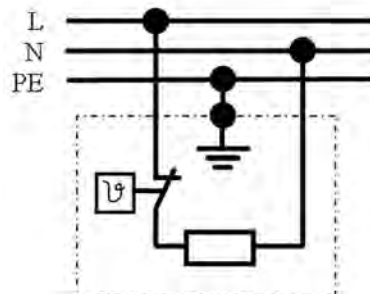
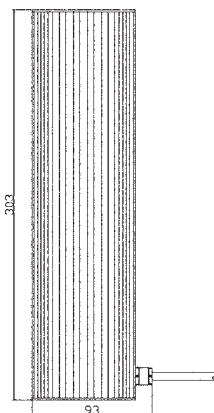
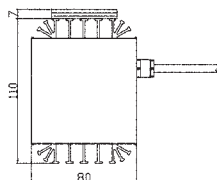

Best.-Nr.	Spannung in V	Leistung in W	Befestigung	Überhitzungsthermostat
WH-14124110051	230	500	Clip für Hutschiene	•



Widerstandsheizung

Typ „LM-Double“



Merkmale / Nutzen

- Gehäuse und Abstrahlkörper aus Aluminium, beidseitig profiliert
- Überzeugt durch besonders gute Wärmeabgabe
- Durch ausgeklügelte Anordnung der Kühlrippen, sowohl senkrecht als auch waagrecht einsetzbar
- Montage auf DIN Hutschiene EN 60715 oder wahlweise auch mit Schraubbefestigung
- Anschluss über 3 x 0,75 mm² Silikonkabel oder optional mit Anschlussstecker
- Alle Typen für Betrieb AC sind mit einem Überhitzungsthermostat ausgestattet
- Hochwertige Kabelzugentlastung aus Messing vernickelt

Anwendung

Die Schaltschrankheizung des Typs „LM-Double“ ist durch die hohe Leistung besonders zum Einsatz in größeren elektrischen Steuerungs-, Schalt- und Regelanlagen sowie in Verteilerschränken geeignet und schützt diese vor zu geringen Temperaturen oder zu hoher Luftfeuchtigkeit.

Die Schaltschrankheizungen des Typs „LM-Double“ in Verbindung mit unseren Thermostaten und Hygrostaten garantiert die Verhinderung von Kondensatbildung innerhalb Ihrer Anlage.

Technische Kennwerte

Spannungen

Spannungen (Heizwiderstand)	230 V, 24 V AC/DC
-----------------------------	-------------------

Leistungen

Leistungen	250 W
------------	-------

Maße / Gewichte

Typ „LM-Double“	316 x 92 x 80 mm – 1098 g
-----------------	---------------------------

Befestigung

Befestigung	Clip für DIN Hutschiene EN 60715 (Standard) oder Schraubbefestigung
-------------	---

Sicherheit

Schutzart	IP 52
Schutzart (optional)	IP 65 (nur mit 230 V)

Anschluss

Anschluss	Silikonkabel 3 x 0,75 mm ² ; Länge 0,5 m (Standard) oder Anschlussstecker
-----------	--

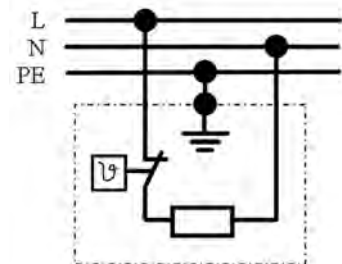
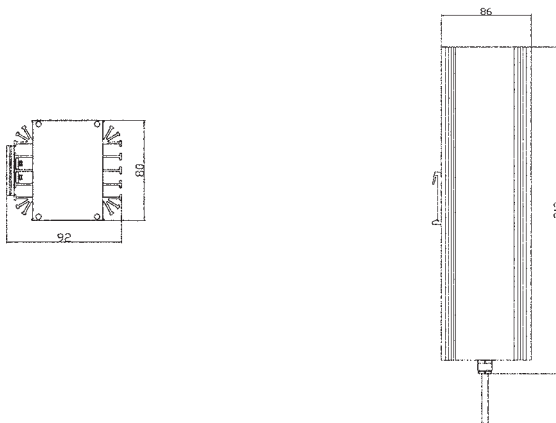

Best.-Nr.	Spannung in V	Leistung in W	Befestigung	Überhitzungsthermostat
WH-15118110051	230	250	Clip für Hutschiene	•
WH-15218110050	24	250	Clip für Hutschiene	



Widerstandsheizung – Serie „Sandwich“

Typ „S1 – S5“



Merkmale / Nutzen

- Gehäuse und Abstrahlkörper aus Aluminium, beidseitig profiliert
- Überzeugt durch besonders gute Wärmeabgabe
- Durch ausgeklügelte Anordnung der Kühlrippen, sowohl senkrecht als auch waagrecht einsetzbar
- Montage auf DIN Hutschiene EN 60715 oder wahlweise auch mit Schraubbefestigung
- Anschluss über 3 x 0,75 mm² Silikonkabel oder optional mit Anschlussstecker
- Mit eingebautem Thermostat möglich
- Hochwertige Kabelzugentlastung aus Messing vernickelt

Anwendung

Die Doppel-Profil-Schaltschrankheizung der Serie „Sandwich“ schützt Ihre Schaltanlage vor zu geringen Temperaturen oder zu hoher Luftfeuchtigkeit. Die Schaltschrankheizungen der Serie „Sandwich“ in Verbindung mit unseren Thermostaten und Hygrostaten garantiert die Verhinderung von Kondensatbildung innerhalb Ihres Schaltschranks

Technische Kennwerte

Spannungen		Befestigung	
Spannungen (Heizwiderstand)	220-240 V; 24 V AC/DC	Befestigung	Clip für DIN Hutschiene EN 60715 (Standard) oder Schraubbefestigung
Leistungen		Sicherheit	
Leistungen	15 W / 30 W / 55 W / 90 W / 125 W / 180 W / 250 W	Schutzart	IP 52
Maße / Gewichte		Anschluss	
Typ S1	75 x 59,5 x 45 mm – 218 g	Anschluss	Silikonkabel 3 x 0,75 mm ² ; Länge 0,5 m (Standard) oder Anschlussstecker
Typ S2	75 x 91 x 45 mm – 294 g	Überhitzungsthermostat	
Typ S3	75 x 116 x 45 mm – 378 g	Ab 50 W Heizleistung	Ausschaltpunkt bei ca. 80 °C Geräteoberflächentemperatur
Typ S4	75 x 166 x 45 mm – 468 g		
Typ S5	75 x 216 x 45 mm – 646 g		

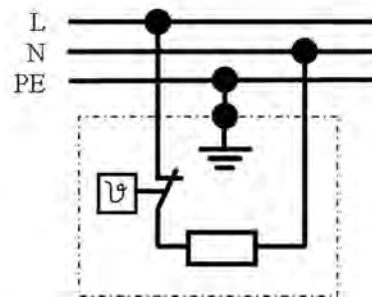
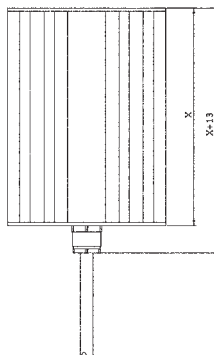
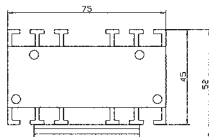



MBS AG

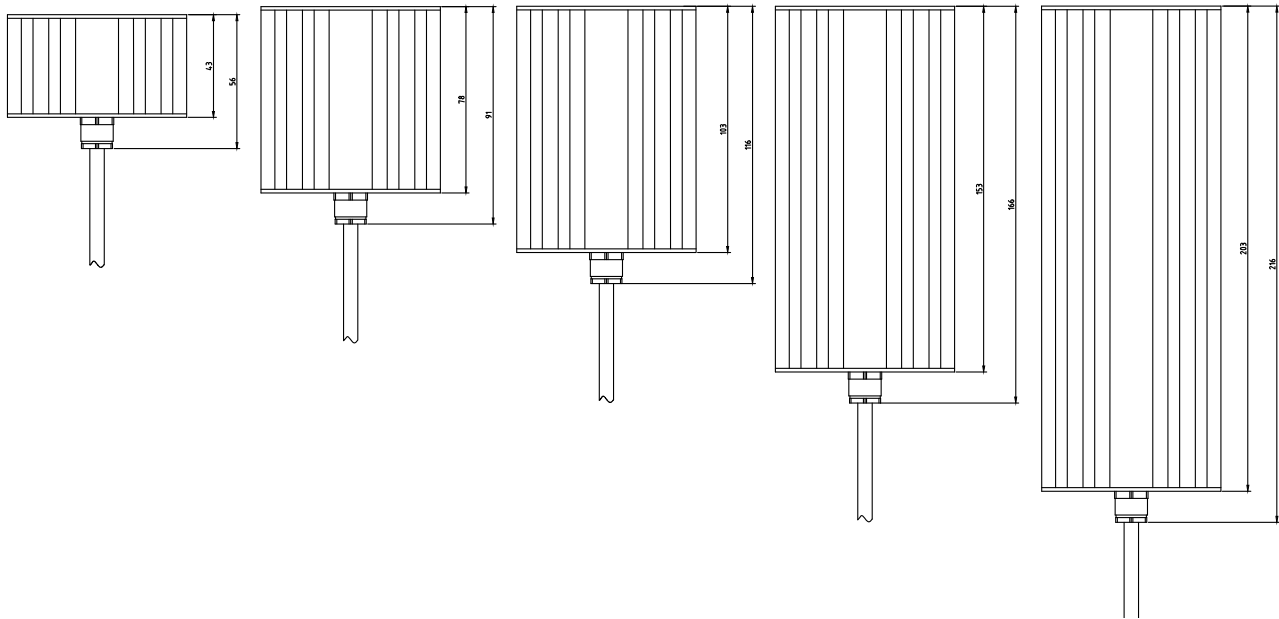

Best.-Nr.	Typ	Spannung in V	Leistung in W	Befestigung	Überhitzungs-thermostat
WH-01102110050	S1	230	15	Clip für Hutschiene	
WH-01202110050	S1	24	15	Clip für Hutschiene	
WH-02105110050	S2	230	30	Clip für Hutschiene	
WH-02205110050	S2	24	30	Clip für Hutschiene	
WH-03108110051	S3	230	55	Clip für Hutschiene	•
WH-03208110050	S3	24	55	Clip für Hutschiene	
WH-04110110051	S4	230	90	Clip für Hutschiene	•
WH-04210110050	S4	24	90	Clip für Hutschiene	
WH-05112110051	S5	230	125	Clip für Hutschiene	•
WH-05212110050	S5	24	125	Clip für Hutschiene	
WH-05116110051	S5	230	180	Clip für Hutschiene	•
WH-05216110050	S5	24	180	Clip für Hutschiene	



Gebälseheizung

Typ „Varix 100“



Merkmale / Nutzen

- Optimale Wärmeverteilung dank des durchdachten Profildesigns
- Schutzgitter auch auf der Heizung
- Oberflächenbehandelt
- Kugelgelagerter Ventilator
- Mit Überhitzungsthermostat
- Einfache Montage auf DIN Hutschiene EN 60715
- Anschluss über 3 x 0,75 mm² Silikonkabel oder optional mit Anschlussstecker
- Hochwertige Kabelzugentlastung aus Messing vernickelt

Anwendung

Die Gebläseheizung des Typs „Varix 100“ schützt Ihre Schaltanlage vor zu geringen Temperaturen oder zu hoher Luftfeuchtigkeit.

Die Gebläseheizungen des Typs „Varix 100“ in Verbindung mit unseren Thermostaten und Hygrostaten garantiert die Verhinderung von Kondensatbildung innerhalb Ihres Schaltschrankes

Technische Kennwerte

Spannungen	
Spannungen (Heizwiderstand)	220-240 V AC, 50/60 Hz
Leistungen	
Leistungen	100 W
Lüfter	
Luftfördermenge	18 m ³ /h freiblasend
Maße / Gewichte	
Typ „Varix 100“	91 x 83,5 x 65 mm – 608 g

Befestigung	
Befestigung	Clip für DIN Hutschiene EN 60715
Sicherheit	
Schutzart	IP 54
Anschluss	
Anschluss	Silikonkabel 3 x 0,75 mm ² ; Länge 0,5 m (Standard)
Überhitzungsthermostat	
Aus	ca. 100 °C
Hysterese	30 K (± 15 K)

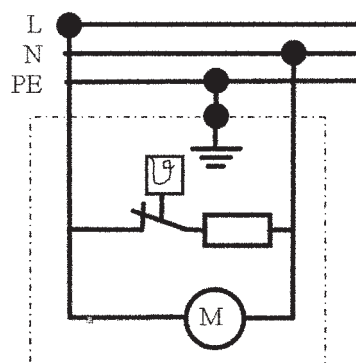
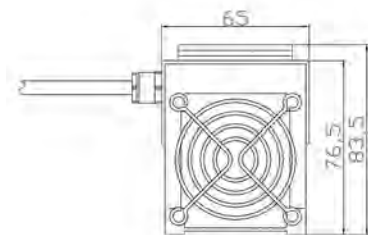
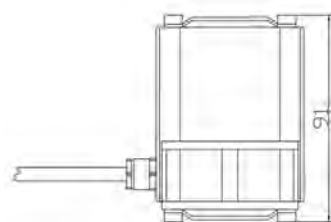

Best.-Nr.	Spannung in V	Leistung in W	Befestigung	Überhitzungsthermostat
GH-18111110051	230	100	Clip für Hutschiene	•

Widerstands-
heizung

Gebläse-
heizungen

Regelgeräte

Zubehör



Gebälseheizung

Typ „Varix 250“



Merkmale / Nutzen

- Optimale Wärmeverteilung dank des durchdachten Profildesigns
- Schutzgitter auch auf der Heizung
- Oberflächenbehandelt
- Kugelgelagerter Ventilator
- Mit Überhitzungsthermostat
- Einfache Montage mittels Schraubbefestigung
- Anschluss über 4-polige Wago CageClamp

Anwendung

Die Gebläseheizung des Typs „Varix 250“ schützt Ihre Schaltanlage vor zu geringen Temperaturen oder zu hoher Luftfeuchtigkeit.

Die Gebläseheizungen des Typs „Varix 250“ in Verbindung mit unseren Thermostaten und Hygrostaten garantiert die Verhinderung von Kondensatbildung innerhalb Ihres Schaltschranks.

Technische Kennwerte

Spannungen	
Spannungen (Heizwiderstand)	220-240 V AC, 50/60 Hz
Leistungen	
Leistungen	250 W
Lüfter	
Luftfördermenge	50 m ³ /h freiblasend
Leistung	12 W
Maße / Gewichte	
Typ „Varix 250“	105 x 114 x 109 mm – 950 g

Befestigung	
Befestigung	Schraubbefestigung
Sicherheit	
Schutzart	IP 50
Anschluss	
Anschluss	Wago CageClamp 4-polig
Überhitzungsthermostat	
Aus	ca. 100 °C
Hysterese	30 K (± 15 K)

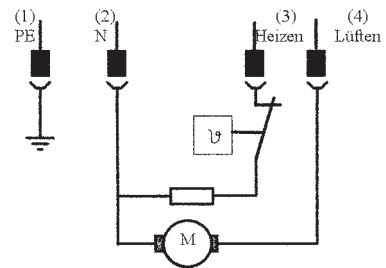
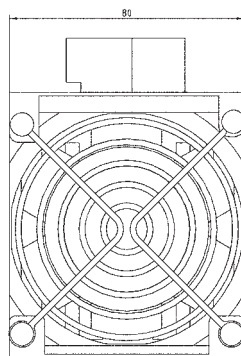
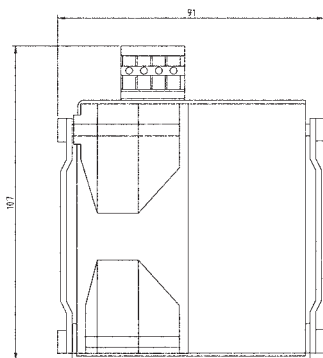

Best.-Nr.	Spannung in V	Leistung in W	Befestigung	Überhitzungsthermostat
GH-19118220001	230	250	Schraubbefestigung	•



Gebälseheizung

Typ „Vario“

Merkmale / Nutzen

- Optimale Wärmeverteilung dank des durchdachten Profildesigns
- Durch ausgeklügelte Anordnung der Kühlrippen, sowohl senkrecht als auch waagrecht einsetzbar
- Schutzgitter auch auf der Heizung
- Oberflächenbehandelt
- Kugelgelagerter Ventilator
- Mit Überhitzungsthermostat
- Einfache Montage auf DIN Hutschiene EN 60715
- Anschluss über 3-poligen Anschlussstecker

Anwendung

Die Gebläseheizung des Typs „Vario“ schützt Ihre Schaltanlage vor zu geringen Temperaturen oder zu hoher Luftfeuchtigkeit.

Die Gebläseheizungen des Typs „Vario“ in Verbindung mit unseren Thermostaten und Hygrostaten garantiert die Verhinderung von Kondensatbildung innerhalb Ihres Schaltschranks.

Technische Kennwerte

Spannungen	
Spannungen (Heizwiderstand)	230 V AC, 115 V AC
Leistungen	
Leistungen	125 W, 250 W, 500 W
Lüfter	
Luftfördermenge	48 m ³ /h freiblasend
Leistung	14/16 W
Maße / Gewichte	
125 W	125 x 80 x 110 mm – 804 g

250 W	185 x 80 x 110 mm – 1138 g
500 W	185 x 80 x 110 mm – 1251 g
Befestigung	
Befestigung	Clip für DIN Hutschiene EN 60715 (Standard) oder Schraubbefestigung
Sicherheit	
Schutzart	IP 20
Anschluss	
Anschluss	3-poliger Steckeranschluss

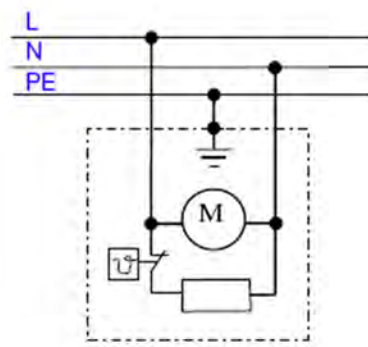
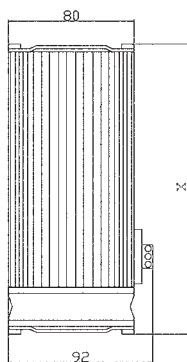
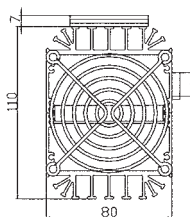

Best.-Nr.	Spannung in V	Leistung in W	Befestigung	Überhitzungsthermostat
GH-20112130001	230	125	Clip für Hutschiene	•
GH-20118130001	230	250	Clip für Hutschiene	•
GH-20124130001	230	500	Clip für Hutschiene	•



Hochleistungs-Gebläseheizung

Typ „HH“

Merkmale / Nutzen

- Überzeugt durch besonders gute Wärmeabgabe
- Waagerechter oder senkrechter Einsatz möglich
- Schutzgitter auch auf der Heizung
- Kugelgelagerter Ventilator
- Mit Überhitzungsthermostat
- Variable Montagemöglichkeiten
- Anschluss über 4-poligen Phoenix-Stecker

Anwendung

Die Hochleistungs-Gebläseheizung des Typs „HH“ schützt Ihre Schaltanlage vor zu geringen Temperaturen oder zu hoher Luftfeuchtigkeit.

Die Hochleistungs-Gebläseheizungen des Typs „HH“ in Verbindung mit unseren Thermostaten und Hygrostaten garantiert die Verhinderung von Kondensatbildung innerhalb Ihres Schaltschranks.

Technische Kennwerte

Spannungen

Spannungen (Heizwiderstand)	230 V AC
--------------------------------	----------

Leistungen

Leistungen	160 W, 250 W, 400 W, 630 W, 1000 W
------------	---------------------------------------

Lüfter

Luftfördermenge	160 m ³ /h freiblasend
Leistung	15/17 W

Maße / Gewichte

160 W	145 x 119 x 70 mm – 1090 g
250 W	145 x 119 x 70 mm – 1090 g

400 W	145 x 119 x 70 mm – 1090 g
-------	----------------------------

630 W	145 x 119 x 80 mm – 1300 g
-------	----------------------------

1000 W	145 x 119 x 85 mm – 1410 g
--------	----------------------------

Befestigung

Befestigung	Haltebügel (Material V2A); Schwenkbar: Best.-Nr. HB-01 Feststehend: Best.-Nr. HB-02
-------------	---

Sicherheit

Schutzart	IP 20
-----------	-------

Anschluss

Anschluss	4-poliger Phoenix-Stecker
-----------	---------------------------

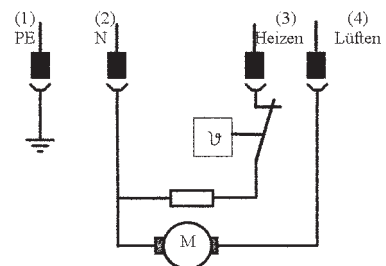
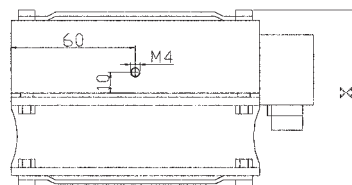
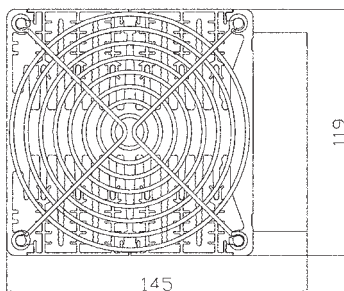

Best.-Nr.	Spannung in V	Leistung in W	Überhitzungsthermostat
GH-22115340001	230	160	•
GH-22118340001	230	250	•
GH-22123340001	230	400	•
GH-22125340001	230	630	•
GH-22127340001	230	1000	•



Thermostat „Öffner“ + „Schließer“

Typ „TH-H“ und „TH-K“

Merkmale / Nutzen

- Kleine Bauweise
- Großer Einstellbereich
- Einfache Montage auf DIN Hutschiene EN 60715
- Anschluss über 2-polige Klemme

Anwendung

Die Kleinthermostate des Typs „TH-H“ und „TH-K“ sind speziell geeignet für den Einsatz in Schaltschränken bzw. in anderen geschlossenen Gehäusen. Der Thermostat des Typs „TH-K“ wird verwendet für die Steuerung von Kühlung, Lüfter oder als Signalgeber. Der Typ „TH-H“ findet Einsatz als Regelung von Heizungen oder Signalgebern.

Technische Kennwerte

Hysterese	
Hysterese	7 K (± 3 K Toleranz)
Einstellbereich	
Einstellbereich	0...60 °C Per Hand und Schraubendreher einstellbar
Maße / Gewichte	
Typ „TH-H“	60 x 33 x 42 mm – 44 g
Typ „TH-K“	60 x 33 x 42 mm – 46 g
Befestigung	
Befestigung	Clip für DIN Hutschiene EN 60715; 35 mm und 15 mm
Sicherheit	
Schutzart	IP 30
EMC	EN 55014-1-2; EN 61000-3-2; EN 61000-3-3

Anschluss	
Anschluss	2-polige Klemme; Anzugsdrehmoment: 0,4 Nm; Klemmbereich max.: 2,5 mm ²
Max. Schaltleistung	
Max. Schaltleistung	AC 250 V, 10 (2) A AC 120 V, 15 (2) A DC 30 VA
Kontakt	
Typ „TH-H“	Bimetall, Öffner
Typ „TH-K“	Bimetall, Schließer
Einsatz- / Lagertemperatur	
Einsatz- / Lagertemperatur	-45 bis +80 °C (-49 bis +176 °F)
Prüfzeichen	
Auf Anfrage	UL CSA VDE (Regler)
Lebensdauer	
Lebensdauer	> 100.000 Zyklen

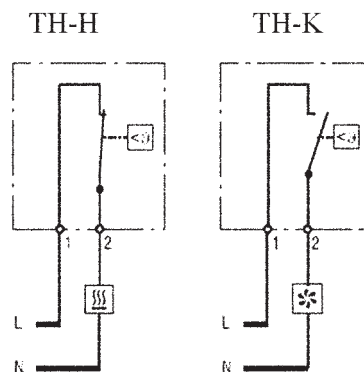
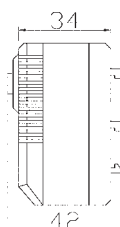
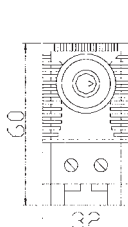

Best.-Nr.	Einstellbereich	Kontakt
TS-011000	0...60 °C	Öffner
TS-012000	0...60 °C	Schließer



Thermostat „Wechsler“

Typ „TH-WE“

Merkmale / Nutzen

- Kleine Bauweise
- Großer Einstellbereich
- Einfache Montage auf DIN Hutschiene EN 60715
- Anschluss über 3-polige Klemme

Anwendung

Der Thermostat Typ „TH-WE“ ist ein mechanischer Wechselkontakt und ist, je nach Anschluss, als Öffner oder Schließer einsetzbar.

Technische Kennwerte

Hysterese

Hysterese	max. 15 K (± 3 K Toleranz)
-----------	---------------------------------

Einstellbereich

Einstellbereich	0...60 °C
-----------------	-----------

Maße / Gewichte

Typ „TH-WE“	67 x 36 x 42 mm – 54 g
-------------	------------------------

Befestigung

Befestigung	Clip für DIN Hutschiene EN 60715
-------------	-------------------------------------

Sicherheit

Schutzart	IP 30
-----------	-------

Anschluss

Anschluss	3-polige Klemme; Anzugsdrehmoment: 0,4 Nm
-----------	--

Max. Schaltleistung

Max. Schaltleistung	AC 250 V, 10 (4) A
---------------------	--------------------

Kontakt

Typ „TH-WE“	Bimetall, Wechsler
-------------	--------------------

Einsatz- / Lagertemperatur

Einsatz- / Lagertemperatur	-45 bis +80 °C (-49 bis +176 °F)
----------------------------	----------------------------------

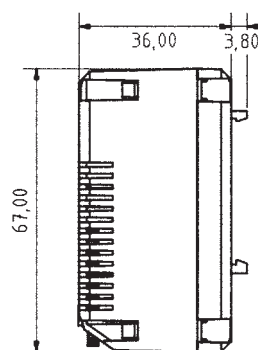
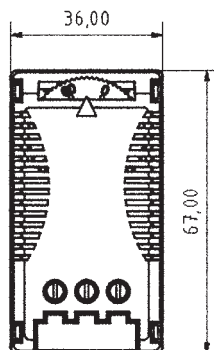

Best.-Nr.	Einstellbereich	Kontakt
TS-013000	0...60 °C	Wechsler



Thermostat mit Fernfühler

Typ „STH-FH 100“

Merkmale / Nutzen

- Kleine Bauweise
- Großer Einstellbereich
- Einstellbare Hysterese
- Einfache Montage auf DIN Hutschiene EN 60715

Anwendung

Die Thermostate des Typs „STH-FH 100“ verfügen über einen NTC Fernfühler. Sie sind besonders geeignet für den Einsatz in Gehäusen, in welchen die Temperatur an abweichender Stelle erfasst werden soll als montiert. Es können sowohl Heizungen als auch Lüfter, Kühlungen geregelt werden.

Technische Kennwerte

Hysterese	
Hysterese	0,5 – 5 K, einstellbar
Einstellbereich	
Einstellbereich	+40...+100 °C -15...+45 °C
Spannungen	
Betriebsspannung	24...240 V AC/DC
Maße / Gewichte	
Typ „STH-FH 100“	90 x 64 x 18 mm – 73 g
Befestigung	
Befestigung	Clip für DIN Hutschiene EN 60715
Sicherheit	
Schutzart	IP 40 an der Frontabdeckung
Anschluss	
Anschluss	A1 – A2 (galvanisch ungetrennt)

Sensor	
Sensor	Fernfühler NTC 3 m (optional auch mit 6 m oder 12 m lieferbar)
Kontakt	
Typ „STH-FH 100“	Schließer – mögliche Einstellung für Heizen/Kühlen (durch DIP-Schalter)
Einsatz- / Lagertemperatur	
Einsatztemperatur	-20...+55 °C
Lagertemperatur	-30...+70 °C
Prüfzeichen	
Auf Anfrage	EN 60730-2-9 EN 61010-1
Lebensdauer	
Lebensdauer	> 100.000 Zyklen

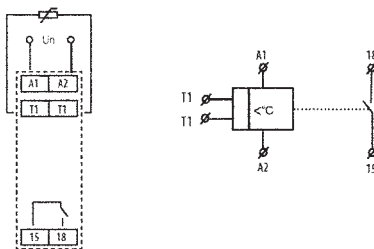

Best.-Nr.	Einstellbereich	Kontakt
TS-062103	40...100 °C	Schließer



Hygrostat

Typ „HY/WE“

Merkmale / Nutzen

- Kleine Bauweise
- Großer Einstellbereich
- Einfache Montage auf DIN Hutschiene EN 60715
- Anschluss über 3-polige Klemme
- Keine Hilfsenergie nötig

Anwendung

Der Hygrostat des Typs „HY/WE“ ist ein elektromechanischer Regler für die relative Luftfeuchtigkeit. Der Schaltkontakt kann direkt zur Ansteuerung der elektrischen Verbraucher verwendet werden.

Die Einstellung des Schaltpunkts (10 % bis 80 % rF) erfolgt mit einem Drehknopf. Am Endanschlag ist der Schalter unabhängig vom Luftfeuchtwert immer geschlossen, bzw. geöffnet.

Technische Kennwerte

Hysterese	
Hysterese	typ. 5 %, Ansprechzeit: 15 Min.
Einstellbereich	
Einstellbereich	10...80 % rel. Luftfeuchtigkeit
Spannungen	
Betriebsspannung	24-230 V AC
Maße / Gewichte	
Typ „HY/WE“	60 x 96 x 45 mm – 164 g
Befestigung	
Befestigung	Clip für DIN Hutschiene EN 60715
Sicherheit	
Schutzart	IP 30
Anwendungsbereich	
Anwendungsbereich	10...90 % rF, 10...40 °C; ohne Kondensation

Anschluss	
Anschluss	3-polige Klemme; Anzugsdrehmoment: 0,4 Nm
Sensor	
Sensor	Polyamidband
Max. Schaltleistung	
Max. Schaltleistung	Befeuchten: 2,2 A Entfeuchten: 5 A
Kontakt	
Typ „HY/WE“	Wechsler
Prüfzeichen	
Auf Anfrage	UL CSA VDE (Regler)

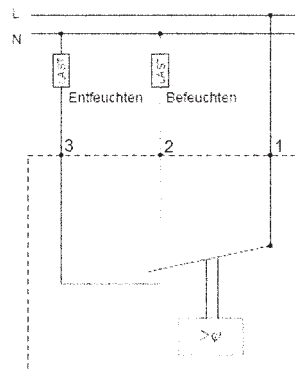
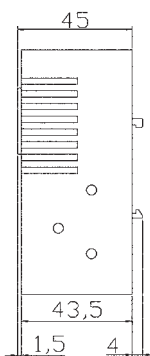
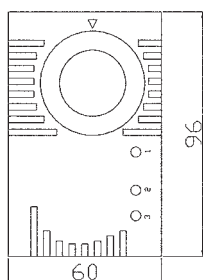

Best.-Nr.	Einstellbereich	Kontakt
HS-073000	10...80 % rF	Wechsler



Hygrostat-Thermostat-Kombination

Typ „HY/TH-H Combi“

Merkmale / Nutzen

- Großer Einstellbereich
- Einfache Montage auf DIN Hutschiene EN 60715
- Anschluss über 3-polige Klemme

Technische Kennwerte

Hysterese	
Hysterese	Hygrostat: 5 % Thermostat: 7 K (± 4 K)
Einstellbereich	
Einstellbereich	Hygrostat: 10...80 % rF; Ansprechzeit: 15 Min. Thermostat: 0...60 °C
Spannungen	
Betriebsspannung	24 – 240 V AC 5A; DC: 30VA
Maße / Gewichte	
Typ „HY/TH-H Combi“	95 x 95 x 49 mm – 466 g

Befestigung	
Befestigung	Clip für DIN Hutschiene EN 60715
Sicherheit	
Schutzart	IP 20
Anschluss	
Anschluss	3-polige Klemme (0,2 – 4 mm ²); Anzugsdrehmoment: 0,6 – 0,8 Nm
Kontakt	
Hygrostat	Schließer
Thermostat	Öffner (auf Wunsch auch als Schließer)

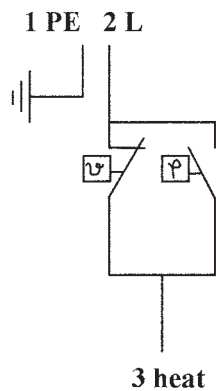

Best.-Nr.	Einstellbereich Hygrostat	Kontakt Hygrostat	Einstellbereich Thermostat	Kontakt Thermostat
HT-085000	10...80 % rF	Schließer	0...60 °C	Öffner



Schaltschrank-Steckdose für DIN-Hutschiene

Typ „SD“

Merkmale / Nutzen

- Kleine Bauweise
- Einfache Montage auf DIN Hutschiene EN 60715
- LED Anzeige

Technische Kennwerte

Spannungen

Betriebsspannung 250 V AC / 16 A

Maße / Gewichte

Typ „SD“ 75 x 45 x 65 mm – 76 g

Befestigung

Befestigung Clip für DIN Hutschiene
EN 60715

Sicherheit

Schutzart IP 20

Anschluss

Anschluss 3 x Schraubanschluss

Einsatz- / Lagertemperatur

Einsatz- / Lagertemperatur -45 bis +70 °C (-49 bis +158 °F)

Einsatz- / Lagerfeuchtigkeit

Einsatz- / Lagerfeuchtigkeit max. 90 % rF;
ohne Kondensation

Best.-Nr.	Befestigung
SD-11	Clip für Hutschiene



- Stromwandler Industrie
- Stromwandler Verrechnung
- Wandler Zubehör
- Sonderwandler
- Stromschienen-Isolatoren/-Halter
- Nebenwiderstände
- Spannungswandler
- Allstromsensoren
- Messumformer
- Energiezähler
- Energiezähler mit MID-Zulassung, Energiezähler-Zubehör
- Schaltschrank-Heizungen und Regelgeräte

