

User manual INDICATOR SWZ-W610

- Firmware: v.1.01 or higher
- Input type: temperature and humidity sensor
- Large-size, 4 x 100 mm + 2 x 57 mm display



Read the user's manual carefully before starting to use the unit or software.
Producer reserves the right to implement changes without prior notice.

CONTENTS

1. BASIC REQUIREMENTS AND USER SAFETY	3
2. GENERAL CHARACTERISTICS	4
3. TECHNICAL DATA	4
4. DEVICE INSTALLATION	6
4.1. UNPACKING.....	6
4.2. ASSEMBLY.....	6
4.3. CONNECTION METHOD.....	7
4.4. MAINTENANCE.....	12
5. FRONT PANEL DESCRIPTION	12
6. DESCRIPTION OF IR REMOTE CONTROLLER	13
7. PRINCIPLE OF OPERATION	14
7.1. DISPLAYING MODE.....	14
7.2. THERMOMETER AND HYGROMETER FUNCTION.....	14
7.2.1. Temperature sensor or temperature and humidity sensor module installation.....	15
7.3. SYNCHRONIZATION OF THE CLOCK WITH DCF77 SIGNAL.....	15
7.3.1. Installation of DCF77 module.....	15
8. DEVICE PROGRAMMING	17
8.1. PROGRAMMING MENU.....	17
8.2. PARAMETERS EDITION.....	17
8.2.1. Numeric parameters (digit change mode).....	17
8.2.2. Numeric parameters (slide change mode).....	18
8.2.3. Switch parameters ("LIST" type).....	18
8.3. MENU DESCRIPTION.....	19
8.3.1. "bri" parameter.....	19
8.3.2. "dLy" menu.....	19
8.3.3. "rtc" menu.....	20
8.3.4. "Func" menu.....	20
8.3.5. "dCF" menu.....	20
8.3.6. "rS" menu.....	22
8.3.7. "Scod" parameter.....	23
8.3.8. "Edit" parameter.....	23
8.3.9. "dEFS" parameter.....	23
8.3.10. "SErv" menu.....	23
8.4. MENU STRUCTURE.....	24
9. THE MODBUS PROTOCOL HANDLING	25
9.1. LIST OF REGISTERS.....	25
9.2. TRANSMISSION ERRORS DESCRIPTION.....	27
9.3. EXAMPLES OF QUERY/ANSWER FRAMES.....	27
10. DEFAULT AND USER'S SETTINGS LIST	29

Explanation of symbols used in the manual:



- This symbol denotes especially important guidelines concerning the installation and operation of the device. Not complying with the guidelines denoted by this symbol may cause an accident, damage or equipment destruction.

IF THE DEVICE IS NOT USED ACCORDING TO THE MANUAL THE USER IS RESPONSIBLE FOR POSSIBLE DAMAGES.



- This symbol denotes especially important characteristics of the unit. Read any information regarding this symbol carefully

1. BASIC REQUIREMENTS AND USER SAFETY



- **The manufacturer is not responsible for any damages caused by inappropriate installation, not maintaining the proper environmental conditions and using the unit contrary to its assignment.**
- Installation should be conducted by qualified personnel . During installation all available safety requirements should be considered. The fitter is responsible for executing the installation according to this manual, local safety and EMC regulations.
- The unit must be properly set-up, according to the application. Incorrect configuration can cause defective operation, which can lead to unit damage or an accident.
- **If in the case of a unit malfunction there is a risk of a serious threat to the safety of people or property additional, independent systems and solutions to prevent such a threat must be used.**
- **The unit uses dangerous voltage that can cause a lethal accident. The unit must be switched off and disconnected from the power supply prior to starting installation of troubleshooting (in the case of malfunction).**
- Neighbouring and connected equipment must meet the appropriate standards and regulations concerning safety and be equipped with adequate overvoltage and interference filters.
- **Do not attempt to disassemble, repair or modify the unit yourself. The unit has no user serviceable parts. Defective units must be disconnected and submitted for repairs at an authorized service centre.**



- In order to minimize fire or electric shock hazard, the unit must be protected against atmospheric precipitation and excessive humidity.
- Do not use the unit in areas threatened with excessive shocks, vibrations, dust, humidity, corrosive gasses and oils.



- Do not use the unit in areas where there is risk of explosions.
- Do not use the unit in areas with significant temperature variations, exposure to condensation or ice.
- Do not use the unit in areas exposed to direct sunlight.
- Make sure that the ambient temperature (e.g. inside the control box) does not exceed the recommended values. In such cases forced cooling of the unit must be considered (e.g. by using a ventilator).



The unit is designed for operation in an industrial environment and must not be used in a household environment or similar.

2. GENERAL CHARACTERISTICS

The **SWZ-W610** digital clock indicates present time, date and temperature or temperature and humidity on 6-digit super-bright LED display. The readings are showed in sequence: present time (hours, minutes and seconds), present date (day of month, month and two last digits of year), temperature (while the device is equipped with optional temperature digital 2-wire sensor) and humidity (while the device is equipped with optional temperature and humidity digital 4-wire sensor). The time is presented in 24-hours mode only, and internal battery preserves proper time counting, even if device is turned off from power supply. The brightness of display can be adjusted in 8 steps.

To **SWZ-W610** user can connect (depending on version) temperature sensor module, temperature and humidity sensor module and (in all versions) DCF77 signal receiver. **Temperature sensor module, temperature and humidity sensor module and DCF77 signal receiver are not part of the device set. It is an additional equipment.**

The device has 4 buttons used for main pre-sets programming. To get higher protection level, the keyboard is mounted under transparent cover. It is possible to set the device using Infra Red controller, or RS 485 serial interface with MODBUS RTU protocol.

The remote controller keyboard is equivalent to the device keyboard (Remote controller is not a part of the **SWZ-W610** set. It is an additional equipment).

3. TECHNICAL DATA

Power supply voltage (depending on version)	85... 230 ...260V AC/DC; 50 ÷ 60 Hz
External fuse (required)	19... 24 ...50V DC; 16... 24 ...35V AC
Power consumption	T - type, max. 2 A max. 11 VA @ 85 ÷ 260V AC/DC max. 11 VA @ 16V ÷ 35V AC max. 10 W @ 19V ÷ 50V DC

Outputs

supply 24V: 24V DC ± 5% / max. 100 mA;
supply 5V: 5V DC ± 5% / max. 50 mA; for measurement sensor
and DCF77 receiver supply,

Inputs

- temperature sensor module: designed to digital temperature sensor, 2-wire connection
- temperature and humidity sensor module: designed to digital temperature and humidity sensor, 4-wire connection
- DCF77 receiver: the receiver output NPN or push-pull type, signal with positive or negative polarization

Displaying range

- temperature (2-wire connection): -40°C to 85°C, resolution: 1°C
- temperature and humidity (4-wire connection): temperature: -40°C to 120°C, resolution: 0.1°C
humidity: 0 to 100%, resolution: 1%
- time: 24h format : hours, minutes seconds
- date: day of month, month, 2 last digits of year

Internal clock battery

non-removable, 3V, Li

Communication interface

RS 485, 8N1 and 8N2, Modbus RTU, not separated

Baud rate

1200 bit/s ÷ 115200 bit/s

Display

LED, 4 digit 100mm height + 2 digit 57mm height, red, with 8-steps brightness regulation

Data memory

non-volatile memory, EEPROM type

Protection level

IP 30

Housing type

Wall mounted

Housing material

aluminium + methyl polimethacrylate

Housing dimensions

578 x 208 x 102 mm

Operating temperature

0°C to +50°C

Storage temperature

-10°C to +70°C

Humidity

5 to 90% no condensation

Altitude

up to 2000 meters above sea level

Screws tightening max. torque

0.5 Nm

Max. connection leads diameter

2.5 mm²

Safety requirements

according to: PN-EN 61010-1
installation category: II
pollution degree: 2
voltage in relation to ground: 300V AC
insulation resistance: >20MΩ
insulation strength between power supply and input/output terminal: 1min. @ 2300V

EMC

according to: PN-EN 61326-1



This is a class A unit. In housing or a similar area it can cause radio frequency interference. In such cases the user can be requested to use appropriate preventive measures.

4. DEVICE INSTALLATION

The unit has been designed and manufactured in a way assuring a high level of user safety and resistance to interference occurring in a typical industrial environment. In order to take full advantage of these characteristics installation of the unit must be conducted correctly and according to the local regulations.



- Read the basic safety requirements on page 3 prior to starting the installation.
- Ensure that the power supply network voltage corresponds to the nominal voltage stated on the unit's identification label.
- The load must correspond to the requirements listed in the technical data.
- All installation works must be conducted with a disconnected power supply.
- Protecting the power supply clamps against unauthorized persons must be taken into consideration.

4.1. UNPACKING

After removing the unit from the protective packaging, check for transportation damage. Any transportation damage must be immediately reported to the carrier. Also, write down the unit serial number on the housing and report the damage to the manufacturer.

Attached with the unit please find:

- user's manual,
- warranty,

4.2. ASSEMBLY



- Disconnect the power supply prior to starting assembly.
- During installation all available safety requirements should be considered.
- The mounting method must to preserve high breaking strength, at least 4 times the mass of the device.
- Check the correctness of the performed connections prior to switching the unit on.



To install the device two holes must be prepared (distance like in **Figure 4.1**) with screws or hooks. The device should be installed using its handles placed on the top of housing.

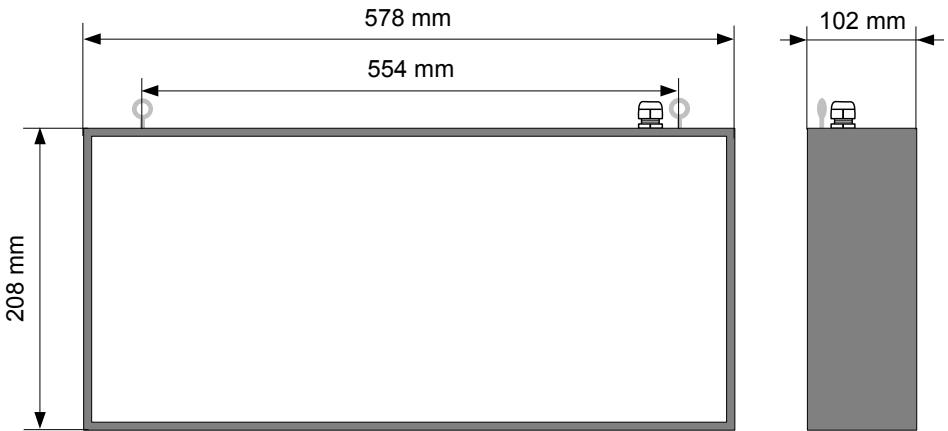

Figure 4.1. Device and assembly dimensions

4.3. CONNECTION METHOD

Caution



- Installation should be conducted by qualified personnel . During installation all available safety requirements should be considered. The fitter is responsible for executing the installation according to this manual, local safety and EMC regulations.
- The unit is not equipped with an internal fuse or power supply circuit breaker. Because of this an external time-delay cut-out fuse with minimal possible nominal current value must be used (recommended bipolar, max. 2A) and a power supply circuit-breaker located near the unit. In the case of using a monopolar fuse it must be mounted on the phase cable (L).
- The power supply network cable diameter must be selected in such a way that in the case of a short circuit of the cable from the side of the unit the cable shall be protected against destruction with an electrical installation fuse.
- Wiring must meet appropriate standards and local regulations and laws.
- In order to secure against accidental short circuit the connection cables must be terminated with appropriate insulated cable tips.
- Tighten the clamping screws. The recommended tightening torque is 0.5 Nm. Loose screws can cause fire or defective operation. Over tightening can lead to damaging the connections inside the units and breaking the thread.
- In the case of the unit being fitted with separable clamps they should be inserted into appropriate connectors in the unit, even if they are not used for any connections.



- Unused clamps (marked as n.c.) must not be used for connecting any connecting cables (e.g. as bridges), because this can cause damage to the equipment or electric shock.

- If the unit is equipped with housing, covers and sealing packing, protecting against water intrusion, pay special attention to their correct tightening or clamping. In the case of any doubt consider using additional preventive measures (covers, roofing, seals, etc.). Carelessly executed assembly can increase the risk of electric shock.

- After the installation is completed do not touch the unit's connections when it is switched on, because it carries the risk of electrical shock.

Due to possible significant interference in industrial installations appropriate measures assuring correct operation of the unit must be applied. To avoid the unit of improper indications keep recommendations listed below.

- Avoid common (parallel) leading of signal cables and transmission cables together with power supply cables and cables controlling induction loads (e.g. contactors). Such cables should cross at a right angle.
- Contactor coils and induction loads should be equipped with anti-interference protection systems, e.g. RC-type.
- Use of screened signal cables is recommended. Signal cable screens should be connected to the earthing only at one of the ends of the screened cable.
- In the case of magnetically induced interference the use of twisted couples of signal cables (so-called "spirals") is recommended. The spiral (best if shielded) must be used with RS-485 serial transmission connections.
- In the case of interference from the power supply side the use of appropriate anti-interference filters is recommended. Bear in mind that the connection between the filter and the unit should be as short as possible and the metal housing of the filter must be connected to the earthing with largest possible surface. The cables connected to the filter output must not run in parallel with cables with interference (e.g. circuits controlling relays or contactors).

Connections of power supply voltage and control signals are executed using the screw connections on the back of the unit's housing.

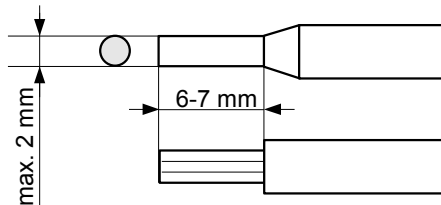

Figure 4.2. Method of cable insulation replacing and cable terminals

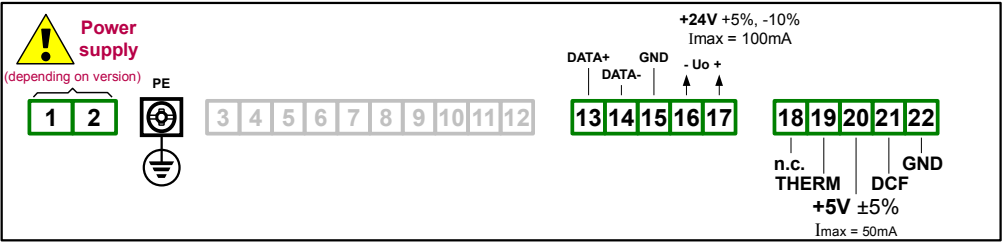

Figure 4.3. Terminals description (version with 2-wire connection)

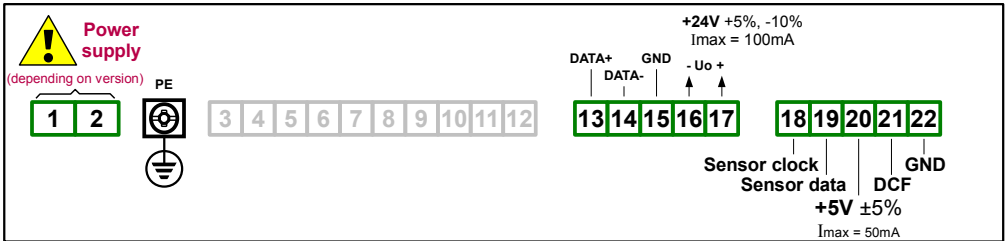

Figure 4.4. Terminals description (version with 4-wire connection)



- All connections must be made while power supply is disconnected
- The device housing should be grounded. Protective Earth (PE) cord should be mounted using eye terminal, connect it with proper screw placed near of power terminals.
Recommended installation torque of Protective Earth terminal is 2 Nm.
- Power supply connection must be made using 3-wire cord.
- **After installation, power cord gland should be tighten up, to prevent cable move.**



Metal housing must be connected with PE (grounded), using terminal marked with symbol:

Be careful while nuts tightening.

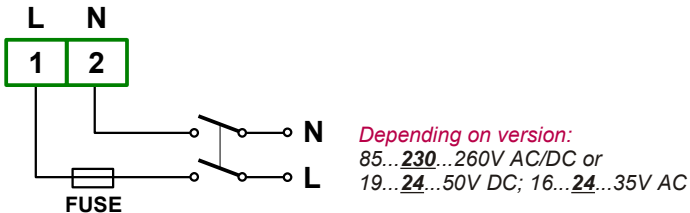

Figure 4.5. Connection of power supply

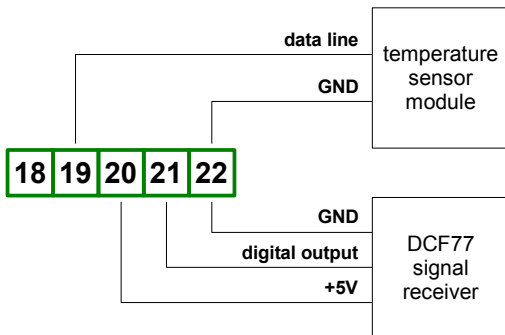

Figure 4.6. Connection of temperature sensor module and DCF77 signal receiver

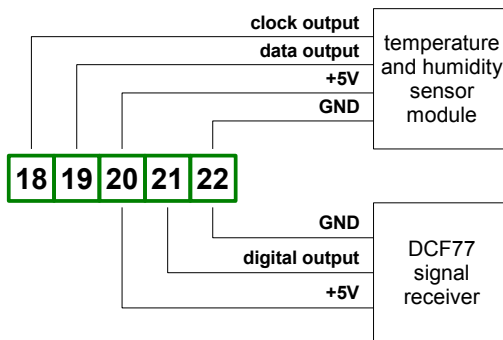

Figure 4.7. Connection of temperature and humidity sensor module and DCF77 signal receiver

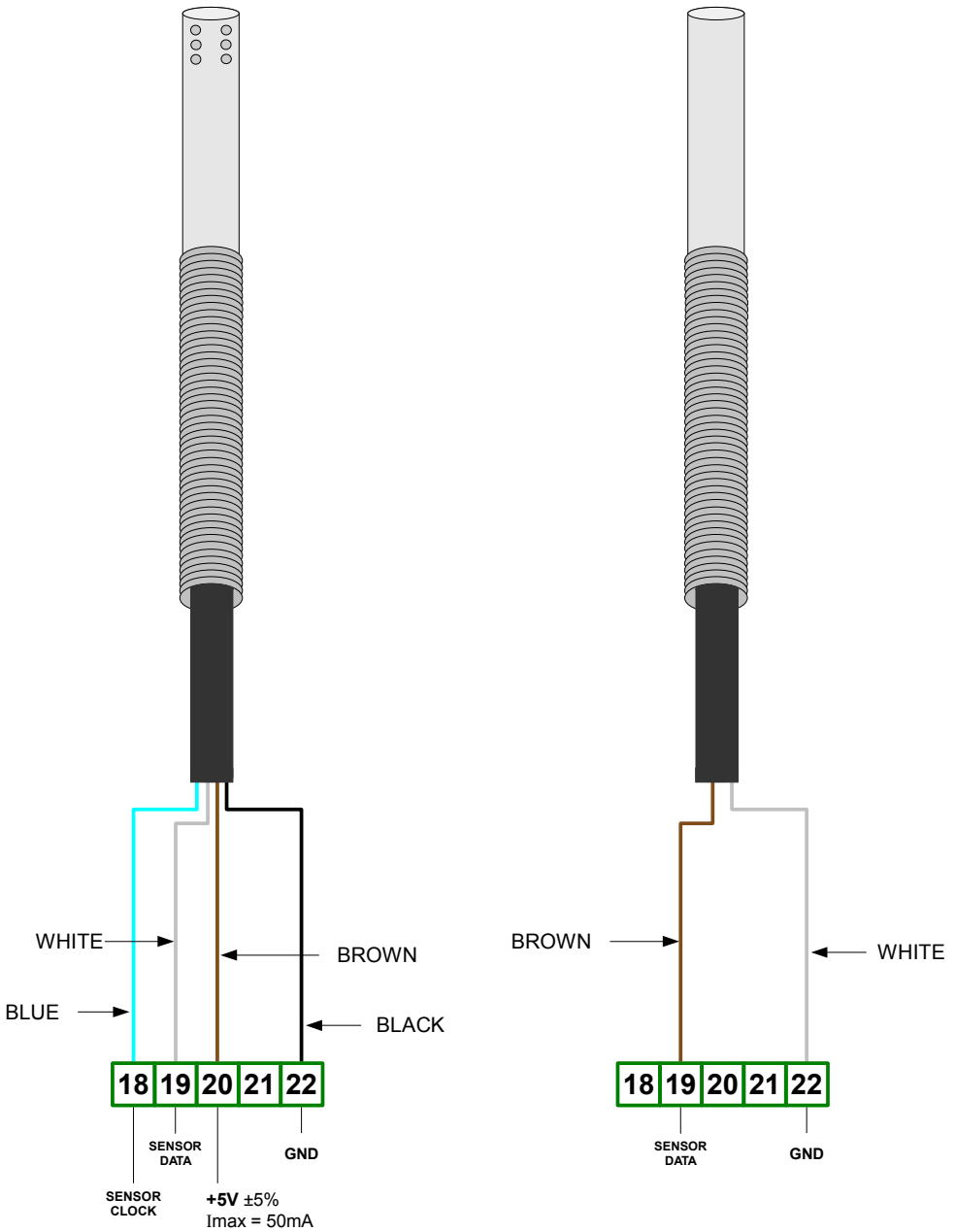

Figure 4.8. Connection of SCT-750 and SCT-753 (on the left), SCT-650 and SCT-653 (on the right)

4.4. MAINTENANCE

The unit does not have any internal replaceable or adjustable components available to the user. Pay attention to the ambient temperature in the room where the unit is operating. Excessively high temperatures cause faster ageing of the internal components and shorten the fault-free time of unit operation.

In cases where the unit gets dirty do not clean with solvents. For cleaning use soft, dry cloth. In the case of more significant contamination use warm water with small amount of detergent to wet the cloth.



Using any other agents can cause permanent damage to the housing.



Product marked with this symbol should not be placed in municipal waste. Please check local regulations for disposal and electronic products.

5. FRONT PANEL DESCRIPTION

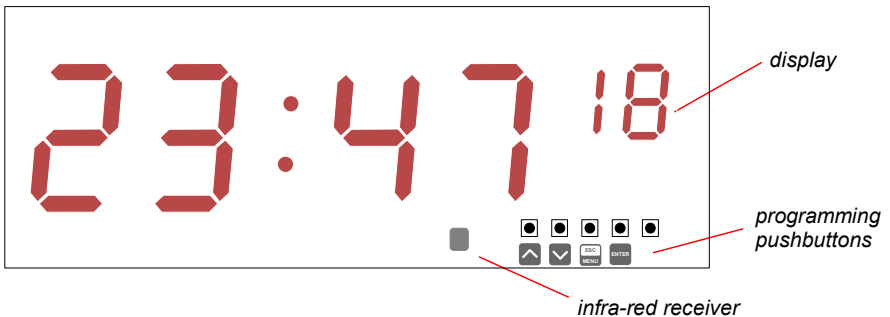

Caution: Due to necessity of housing opening while use of internal keyboard - it should be done very carefully by a fitter. If changes of parameters must be done often, it is recommended to use optional IR controller.

Symbols and functions of push-buttons:



Symbol used in the manual: **[ESC/MENU]**

Functions:

- Enter to main menu (press and hold by at least 2 sec.)
- Exit the current level and Enter to previous menu (or displaying mode)
- Cancel the changes made in parameter being edited



Symbol used in the manual: **[ENTER]**

Functions:

- Start to edit the parameter
- Enter to the sub-menu,
- Confirmation of changes made in parameter being edited
- Changing of display mode, in sequence: present time, present date and temperature (optional)



Symbol used in the manual: [^] [v]

Functions:

- Change of the present menu,
- Modification of the parameter value,
- Change of the display mode.

6. DESCRIPTION OF IR REMOTE CONTROLLER

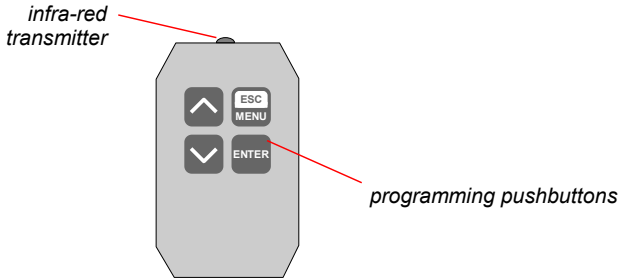

Symbols and functions of push-buttons:



Symbol used in the manual: [ESC/MENU]

Functions:

- Enter to main menu (press and hold by at least 2 sec.)
- Exit the current level and Enter to previous menu (or displaying mode)
- Cancel the changes made in parameter being edited



Symbol used in the manual: [ENTER]

Functions:

- Start to edit the parameter
- Enter to the sub-menu,
- Confirmation of changes made in parameter being edited



Symbol used in the manual: [^] [v]

Functions:

- Change of the present menu,
- Modification of the parameter value,
- Change of the display mode.

7. PRINCIPLE OF OPERATION

After turning the power supply on, device ID and software version are showed on the display, next the digital indicator goes to the display mode.

7.1. DISPLAYING MODE

In normal mode current time is presented in format „**hours:minutes seconds**” or current date in format „**day.month.year**”. Additionally, if digital temperature sensor module or temperature and humidity sensor module (depending on version) is connected to {**THERM**} (see **Figure 4.6**) or {**Sensor data**} and {**Sensor clock**} (see **Figure 4.7**) (depending on version) input, the device can display current temperature or temperature and humidity. The display can show only one of these parameters, or can change them in sequence, with periods selected by user.

The displaying time of particular readings are defined by parameters “**dL c**” (time displaying period), “**dL d**” (date displaying period), “**dL t**” (temperature displaying period) and “**dL h**” (humidity display period).



- To omit the date in displaying sequence, parameter “**dAtE**” of “**Func**” menu must be switched to “**oFF**”. If “**dAtE**” = “**oFF**”, then parameter “**dL d**” is unavailable.
- To add displaying of temperature in sequence, thermometer function must be on (parameter “**thEr**” of “**Func**” menu set to “**CELS**” or “**FAhr**”). If this function is off (“**thEr**” = “**oFF**”) parameter “**dL t**” is unavailable.
- To add displaying of humidity in sequence, hygrometer function must be on (parameter “**humi**” of “**Func**” menu set to “**on**”). If this function is off (“**humi**” = “**oFF**”) parameter “**dL h**” is unavailable.

Pressing “**ENTER**” button, user can switch display to show selected reading. Successive pressing of this button causes in displaying of next reading in the cycle.

Setting any of “**dL c**”, “**dL d**” or “**dL t**” display period to „00” (zero) causes in stopping of the sequence corresponding reading. If user press “**ENTER**” button after stopping the sequence, and display period of current reading is different than 0, the sequence run until next reading with display period equal „00”.

If displaying periods of all readings are set to zero, then successive pressing of “**ENTER**” button switches readings, and they are displayed permanently.

All accessible parameters can be changed by entering the menu (see: **DEVICE PROGRAMMING**). Use the local keyboard or the remote controller to do it. (Note: all parameters can be remote changed via RS-485 interface).



Configuration of the device (via menu or RS 485 interface) **do not stops device.**

7.2. THERMOMETER AND HYGROMETER FUNCTION

The **SWZ-W610** is equipped with {**THERM**} input which allows to connect digital thermometer module to the device or optional it can be equipped with {**Sensor data**} and {**Sensor clock**} which allows to connect digital thermometer and humidity module to the device. To enable displaying of temperature in the sequence, the thermometer function must be on (parameter “**thEr**” of “**Func**” menu set to “**CELS**” or “**FAhr**”). Parameter “**dL t**” defines display time of temperature. Analogously, to enable displaying of humidity in the sequence, the hygrometer function must be on (parameter “**humi**” of “**Func**” menu set to “**on**”). Parameter “**dL h**” defines display time of humidity.

7.2.1. Temperature sensor or temperature and humidity sensor module installation

Avoid of mounting the module near of the doors, windows (specially near of rooms with different temperature), in places of high air flow, sunny places and near of artificial light sources (like bulbs) etc.



Due to possibility of electromagnetic noise while using long connection wires, a temperature sensor should be equipped with denoising filter.

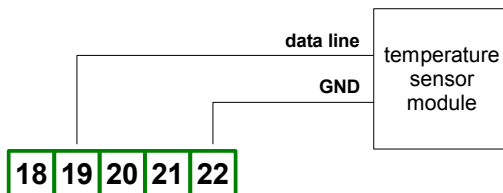

Figure 7.1. Connection of temperature sensor module to **SWZ-W610**

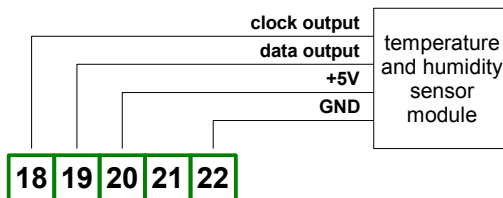

Figure 7.2. Connection of temperature and humidity sensor module to **SWZ-W610**

7.3. SYNCHRONIZATION OF THE CLOCK WITH DCF77 SIGNAL

The DCF77 is a radio signal contained informations about current time (central Europe). Sending time is official UE time. Amplitude modulated signal is sent in LW band on 77.5 kHz frequency. The transmitter is placed in Mainflingen, near of Frankfurt (Germany), and has about 2500km of coverage (power about 50 kW). There are coded informations about current hour, minute, date, day of week in the signal, and they are synchronized to high-precision atomic time standard. One data pocket is transmitted over 59 seconds.

7.3.1. Installation of DCF77 module

To obtain proper reception of DCF77 signal, correct location and orientation of receiver aerial is essential. Due to DCF77 receivers are usually sensitive to electromagnetic noise (also generated by computers, monitors, TV sets, motors and other devices), it is recommended to place them far off of the noise sources. Periodical disturbances in reception can be caused by storms. Unfortunately in unfavourable conditions, proper reception of full information can be possible only at night, while all sources of disturbances are off.

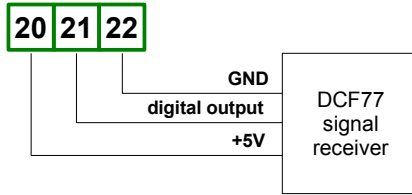

Figure 7.3. Connection of DCF77 module to SWZ-W610

It is recommended to set „on” parameter „diSP” of „dCF” submenu. It allows to observe DCF module output state (after connection to {DCF} input). If resting state of the module output had been set correctly (see parameter „mode” of „dCF” submenu), then digital point of most right digit flashes in time with the DCF signal bits (see **Figure 7.4**). The time while LED is on should be shorter than time while LED is dark. The additional test of correct orientation of the aerial is number of received bits (see parameter „Sync” of „dCF” submenu). Aerial should be oriented in that way, to allow collection of 3 full frames, every of 59 bits. If the number of received bits is zeroed before collection of full frame, it means that signal, is to weak (or noises are to strong) . It is recommended to change localisation and /or orientation of the aerial.

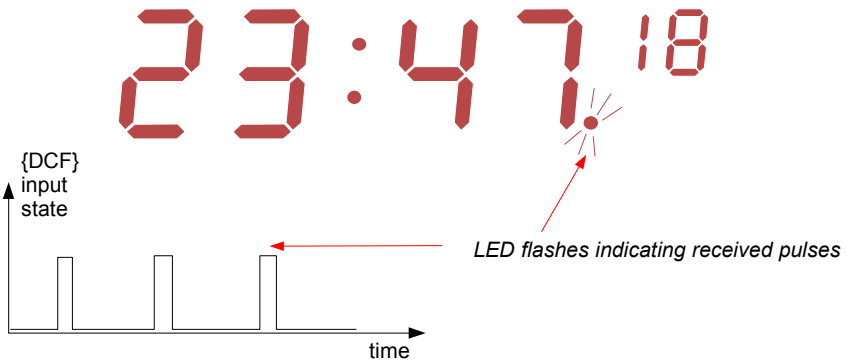

Figure 7.4. Signalisation of DCF module output state.



If it is impossible to synchronize clock with DCF signal for 7 days (no signal, or errors in received data) the double dot between hour and minutes will start to pulse in asymmetrical mode (lighting time much shorter than time of dimming).

8. DEVICE PROGRAMMING

The device menu allow user to set all parameters connected to operation of the display, control modes, communication via RS-485 and access settings. The meaning of the particular parameters is described in paragraph **MENU DESCRIPTION**.

8.1. PROGRAMMING MENU

To enter main menu (being in the displaying mode) operator must to press and hold at least 2 sec. **[ESC/MENU]** button.

If the user password is defined (see parameter “**Scod**“), operator have to enter correct one before proceeding to menu options . Entering of the passwords is similar to the edition of numeric parameters (see: **PARAMETERS EDITION**), however presently editing digit is showed only on the display, other digits are replaced by “-” sign.

After entering of last digit of the password first menu position will be displayed (if the password is correct) or warning “**Err**” in other case.

Functions of the buttons while sub-menu and parameters choice:



Selection of sub-menu or parameter for editing. Name of selected item (sub-menu or parameter) is displayed.



Operation of **[ENTER]** button depend on present menu position:

- if the name of some sub-menu is displayed - enter this sub-menu; name of the first parameter (or next level sub-menu) is displayed,
- if the name of some parameter is displayed - enter the edition of this parameter; present value of the parameter is displayed,



[ESC/MENU] button allow user to exit present menu level and goes to upper level menu (or displaying mode).



After about 1 min. since last use of the buttons, device exits the menu mode and returns to the displaying mode (only if no parameters are in editing mode).

8.2. PARAMETERS EDITION

To start edition of any parameter user should select name of desired one using **[^]** **[v]** buttons and then press **[ENTER]**.

8.2.1. Numeric parameters (digit change mode)

Numerical parameters are displayed as decimal numbers. The mode of its new value entering depends on chosen edit method (see parameter “**Edit**“).

In mode “by digit” (“**Edit**”=“**dig**”) pressing one of the keys **[^]** or **[v]** causes change of current position (flashing digit) or the sign (+/-). Short pressing of the **[ENTER]** button causes change of the position (digit).

Press **[ENTER]** at least 2 seconds to accept the changes, after that question “**Set?**” is displayed, and user must to confirm (or cancel) the changes. To conform changes (and store it in EEPROM) press **[ENTER]** button shortly after “**Set?**” is displayed. To cancel the changes press **[ESC]** button shortly after “**Set?**” is displayed. After that device returns to the menu.

8.2.2. Numeric parameters (slide change mode)

In “slide change” mode (“Edit”=“Slid”), buttons [^] and [v] has different functions.

To increase edited value press (or press and hold) [^] button only, the increasing became quickest as long as button [^] is pressed. To slow down the increasing, button [v] can be used. If [v] is pressed shortly (and button [^] is still pressed), increasing slow down for a moment only, if [v] is pressed and held while button [^] is still pressed the increasing slow down and will be kept on lower speed.

To decrease edited value press (or press and hold) [v] button only. The decreasing became quickest as long as button [v] is pressed. To slow down the decreasing, button [^] can be used. If [^] is pressed shortly (and button [v] is still pressed), decreasing slow down for a moment only, if [^] is pressed and held while button [v] is still pressed the decreasing slow down and will be kept on lower speed.

Press [ENTER] at least 2 seconds to accept the changes, after that question “Set?” is displayed, and user must to confirm (or cancel) the changes. To conform changes (and store it in EEPROM) press [ENTER] button shortly after “Set?” is displayed. To cancel the changes press [ESC] button shortly after “Set?” is displayed. After that device returns to the menu.

8.2.3. Switch parameters (“LIST” type)

Switch parameters can be described as a sets of values (a lists) out of which only one of the options available on the list can be selected for the given parameter. Options of switching parameter are selected using [^], [v] keys.

Short pressing of [ENTER] causes in displaying of the acknowledge question (“Set?”). If key [ENTER] is pressed again, the changes are accepted, stored in EEPROM end the edition process finished. Pressing the key [ESC] after “Set?” causes in cancelling of made changes and returning to menu.

Functions of buttons when editing numeric and switching parameters:



While editing numeric parameter:

- change of current (flashing) digit
- slide change of value (acceleration, deceleration, direction change)

While editing switch parameter - selection of switch parameter.



If numerical parameter is being edited, a short press of [ENTER] button change edited position. A long press of [ENTER] button (at least 2 sec.) causes of display a “Set?” ask, which allow user to make sure if change of the parameter value is correct. If switch parameter is being edited, a short press of [ENTER] button causes of display a “Set?” ask. When [ENTER] button is pressed again (while “Set?” is displayed) the new value of the parameter is stored in EEPROM memory.



Pressing this button operator can cancel the changes done up to now (if they were not approved by [ENTER] button after the “Set?” ask) and come back to menu

8.3. MENU DESCRIPTION

“- - -” - password checking. If some password different from “0000” is set, then every enter to main menu follows the entering of password. If entered password is correct then first menu position will be displayed else warning “Err”, and unit returns to displaying mode.



Due to problem with direct displaying of “m” letter, it is exchanged with special sign “ñ”. Independently in user manual letter “m” is used to make it more readable (example: “modE”).

8.3.1. "bri" parameter

This parameter allows user to set bright of the LED display, bright can be set to conventional values from “bri1” to “bri8”.

8.3.2. "dLy" menu

This menu allows to change the display time of particular readings.

“dL c” - this parameter defines the displaying period of current time (in format “hours:minutes seconds”), in range from 1 to 99 seconds. Setting this parameter to “00” causes in permanent displaying of time (after switch device to display it).

“dL d” - this parameter defines the displaying period of current date (in format “day.month.year”), in range from 1 to 99 seconds. Setting this parameter to “00” causes in permanent displaying of date (after switch device to display it).

“dL t” - this parameter defines the displaying period of current temperature, in range from 1 to 99 seconds. Setting this parameter to “00” causes in permanent displaying of temperature (after switch device to display it).

“dL h” - this parameter defines the displaying period of current humidity, in range from 1 to 99 seconds. Setting this parameter to “00” causes in permanent displaying of humidity (after switch device to display it).



- To omit the date in displaying sequence, parameter “dAtE” of “Func” menu must be switched to “oFF”. If “dAtE” = “oFF”, then parameter “dL d” is unavailable.
- To add displaying of temperature in sequence, thermometer function must be on (parameter “thEr” of “Func” menu set to “CELS” or “FAhr”). If this function is off (“thEr” = ”oFF”) parameter ”dL t” is unavailable.
- To add displaying of humidity in sequence, hygrometer function must be on (parameter “humi” of “Func” menu set to “on”). If this function is off (“humi” = “oFF”) parameter “dL h” is unavailable.

8.3.3. "rtc" menu

This menu allows to set date and time:

- "cLoc"** - use this parameter to set current time (hour, minute and second)
- "dAtE"** - use this parameter to set current date (day of month, month and year)

8.3.4. "Func" menu

This menu allows to set operation mode:

- "dAtE"** - this parameter allows to switch on/off displaying of the date
- "yEAr"** - this parameter allows to switch on/off displaying of the year while date is showed:
 - "oFF"** - displaying of the year is off,
 - "on"** - displaying of the year is on,
- "thEr"** - this parameter allows to switch on/off displaying of the temperature. If temperature sensor module (see **Figure 4.6**) or temperature and humidity sensor module (see **Figure 4.7**) is not connected to appropriate input, or if it is damaged, the signs „- - -" will be displayed in place of current temperature.
 - "oFF"** - temperature measurement is off,
 - "CELS"** - temperature is measured in degrees Celsius,
 - "FAhr"** - temperature is measured in degrees Fahrenheit,
- "humi"** - this parameter allows to switch on/off displaying of the humidity. If temperature and humidity sensor is not connected to the appropriate input (see **Figure 4.7**), or if it is damaged, the signs „- - -" will be displayed in place of current humidity.
 - "oFF"** - humidity measurement is off,
 - "on"** - humidity measurement is on,

8.3.5. "dCF" menu

This menu contains parameters corresponding to cooperation with DCF77 module.

- "modE"** - this parameter enables synchronization of internal clock with DCF77 signal, and allows to define resting state of the module output. There are available values:
 - "oFF"** - synchronization is off
 - "L Lo"** - synchronization is on, the resting state of DCF module output is LOW
 - "L Hi"** - synchronization is on, the resting state of DCF module output is HIGH



If it is impossible to synchronize clock with DCF signal within 7 days (no signal, or errors in received data) the double dot between hour and minutes will start to pulse in asymmetrical mode (lighting time much shorter than time of dimming).

"diSP" - this parameter allows to on/off the signalisation of DCF77 module output state by LED (digital point of the most right digit). Lighting LED means high state of DCF output. This parameter can be set to:

- "off"** - signalisation is off,
- "on"** - signalisation is on.

"Sync" - this submenu allows to check the time of the last synchronization, the number of correct received frames and bits of DCF77 signal.

- "hours:minutes seconds"** - the time of last synchronization
- "day.month.year "** - the date of last synchronization,
- "F NF"** - number of received frames, where NF is the number of frames in range 0 to 3
- "b NB"** - number of received bits, where NB is the number of bits in range 0 to 59

The manner of presentation of these informations is showed in **Figure 8.1**. The first information after selection **"Sync"** (and pressing the **"ENTER"** button) is the time of last synchronization (e.g. 23:25:00). Subsequent pressings the **[v]** button, cause in displaying of another informations in showed order; the date of last synchronization (e.g. 19th of may 2005), the number of correctly received frames (e.g. 2 frames) and the number of collected bits of frame being received (e.g. 47 bits).



Figure 8.1. Example of informations showed by „Sync” submenu.

While receiving correct DCF77 signal, the number of bits and frames are updated in real time.



Menus **"diSP"** and **"Sync"** make easy installation of the DCF77 module. If parameter **"modE"** is set, then after entering the **"diSP"** menu, time of LED indicator should be more longer than dimming time. Changing number of received bits can be observed using **"Sync"** submenu, and can be confirmation of correct installation of the module.

8.3.6. "rS" menu

This menu is connected with RS-485 interface, and sets his properties:

"Addr" - this parameter defines the address of the device, accordingly to Modbus protocol. It can be set in range from 0 to 199. If the value 0 is set then device, responds to frames with address 255 (FFh).



Every **SWZ-W610** connected to the same serial network should have its own address, different from other devices addressed.

"bAud" - this parameter determines RS-485 interface baud rate. It can be set to one of 8 possible values: **"1.2"**, **"2.4"**, **"4.8"**, **"9.6"**, **"19.2"**, **"38.4"**, **"57.6"**, **"115.2"**, which respond to the baud rates of 1200, 2400, 4800, 9600, 19200, 38400, 57600 and 115200 bit/s respectively.

"mbAc" - this parameter sets the access to the configuration registers of the device. Possible values:

"on" - configuration registers can be set via RS-485 interface,

"oFF" - configuration registers can not be set via RS-485 interface.

"rESP" - this parameter defines minimal (additional) delay between the Modbus message and the answer of the device (received and sent via RS-485 interface). This additional delay allows the device to work with poor RS-converters which do not works properly on baud rates higher than 19200. This parameter can be set to one of values:

"Std" - answer as quick as possible, no additional delay

" 10c"

" 20c"

" 50c"

"100c"

"200c"

- answer delayed of 10, 20, 50, 100 of 200 chars respectively, where one character time depends on selected baud rate



In the most cases parameter "rESP" should be set to "Std" (no additional delay). Unfortunately for some third party RS-converters "rESP" should be adjusted experimentally. Table 8.1 contains most frequently used values.

"bAud" parameter	"38.4"	"57.6"	"115.2"
"rESP" parameter	" 10c"	" 20c"	" 50c"

Tab.8.1. Settings of "rESP" parameter

8.3.7. "Scod" parameter

This parameter defines user password (4-digits number). If this parameter is set at value "0000", user password is turned off.

If the user do not remember his password, the access to the menu is possible by the "one-use password". To get this password please contact with Marketing Division. "Single use password" can be used only one time, after that it is destroyed. Entering this password causes in clearing of user password, it means sets the user password to "0000".



The "one-use password" can be used **ONE TIME ONLY**, it is impossible to use it again! The "one-use password" can be restored by Service Division only.

8.3.8. "Edit" parameter

This parameter allows to change the edition mode of numerical parameters:

- "dig"** - the change to "by digit" mode,
- "Slid"** - slide change mode.

8.3.9. "dEFS" parameter

This setting allows to restore the factory settings of the device. To get the access to this option special password is required: "5465", next the device displays acknowledge question "SEt?". Press **[ENTER]** to acknowledge the restoring of factory settings or **[ESC]** to cancel.

8.3.10. "SErv" menu

This menu contains the parameters for authorized service only. To enter this menu proper service password must be entered. Improper settings can causes of damage of the device.

9. THE MODBUS PROTOCOL HANDLING

Transmission parameters: 1 start bit, 8 data bits, 1 or 2 stop bit (2 bits are send, 1 and 2 bits are accepted when receive), no parity control
 Baud rate: selectable from: 1200 to 115200 bits/second
 Transmission protocol: MODBUS RTU compatible

The device parameters and display value are available via RS-485 interface, as HOLDING-type registers (numeric values are given in U2 code) of Modbus RTU protocol. The registers (or groups of the registers) can be read by 03h function, and wrote by 06h (single registers) or 10h (group of the registers) accordingly to Modbus RTU specification. Maximum group size for 03h and 10h functions can not exceeds 16 registers (for single frame).



The device interprets the broadcast messages, but then do not sends the answers.

9.1. LIST OF REGISTERS

Register	Write	Range	Register description
10h	No	0÷6	Days of the week registry: 0 - Sunday, 1 - Monday, etc.
11h	Yes	2000+2099	Year registry
12h	Yes	1÷12	Months registry
13h	Yes	1÷31	Days registry
14h	Yes	0÷23	Hours registry
15h	Yes	0÷59	Minutes registry
16h	Yes	0÷59	Seconds registry
17h	Yes	see descr.	Control registry for time-related settings: 00h - startup of continued update of registries 10h ÷ 16h by internal clock (current time and date), 80h - stopping update of registries 10h ÷ 16h by internal clock (automatically after writing one of 10h ÷ 16h registries). In this status 11h ÷ 16h registries can be written with new values in order to update internal clock settings. Updating the clock settings with contents of 11h ÷ 16h registries can be executed by sending the following commands to the control registry: 01h - hour update on the basis of (14h ÷ 16h) registries' contents; 02h - date update on the basis of (11h ÷ 13h) registries' contents; 03h - time and date update on the basis of (11h ÷ 16h) registries' contents. After sending commands 01h , 02h or 03h the contents of registries automatically return to 0.
18h	No	-40÷85	Temperature measured by digital thermometer module
19h	No	0÷100	Humidity measured by digital thermometer and hygrometer module
20h ¹	Yes	0÷199	Device address
21h	No	205Ah	Device identification code
22h ²	Yes	0÷7	"bAud" parameter in "rS" menu (baud rate); 0 - 1200 baud; 1 - 2400 baud; 2 - 4800 baud; 3 - 9600 baud; 4 - 19200 baud; 5 - 38400 baud; 6 - 57600 baud; 7 - 115200 baud

Register	Write	Range	Register description
23h ³	Yes	0 ÷ 1	“ mbAc ” parameter in “ rS ” menu (permission to write registers via RS-485 interface); 0 - write denied ; 1 - write allowed
25h	Yes	0 ÷ 5	“ rESP ” parameter in “ rS ” menu (additional response delay); 0 - no additional delay; 1 - “ 10c ” option; 2 - “ 20c ” option; 3 - “ 50c ” option; 4 - “ 100c ” option; 5 - “ 200c ” option;
2Dh ⁴	Yes	1 ÷ 8	“ bri ” parameter (display brightness); 1 - the lowest brightness; 8 - the highest brightness
2Fh	Yes	0 ÷ 1	“ Edit ” parameter (numerical parameters edit mode); 0 - “ dig ” mode; 1 - “ SLid ” mode
31h ⁴	Yes	1 ÷ 8	Dynamically driving of display brightness via serial interface
34h	Yes	0+99	“ dL c ” parameter in “ dLy ” menu (period of time displaying); 0 - permanently; 1÷99 – period expressed in seconds
35h	Yes	0+99	“ dL d ” parameter in “ dLy ” menu (period of date displaying); 0 - permanently; 1÷99 – period expressed in seconds
36h	Yes	0+99	“ dL t ” parameter in “ dLy ” menu (period of temperature displaying); 0 - permanently; 1÷99 – period expressed in seconds
37h	Yes	0+99	“ dL h ” parameter in “ dLy ” menu (period of humidity displaying); 0 - permanently; 1÷99 – period expressed in seconds
38h	Yes	0÷1	“ dAtE ” parameter in “ Func ” menu (date displaying); 0 - disabled; 1 – enabled
39h	Yes	0÷1	“ yEAr ” parameter in “ Func ” menu (display year while date); 0 - disabled; 1 – enabled
3Ah	Yes	0÷2	“ thEr ” parameter in “ Func ” menu (temperature displaying); 0 - disabled; 1 – temperature in degrees Celsius; 2 – temperature in degrees Fahrenheit
3Bh	Yes	0÷1	“ humI ” parameter in “ Func ” menu (humidity displaying); 0 – disabled; 1 – enabled
3Ch	Yes	0÷2	“ modE ” parameter in “ dCF ” menu (time synchronization) 0 - synchronization is off; 1 - synchronization is on, the resting state of DCF module output is LOW ; 2 - synchronization is on, the resting state of DCF module output is HIGH
3Dh	Yes	0÷1	“ diSP ” parameter in “ dCF ” menu (DCF module output displaying) 0 - disabled; 1 - enabled.
3Eh	No	see descr.	High byte: number of correctly received frames; range 0 to 3 Low byte: number of collected bits of frame being received; range 0 to 59

- 1 - after writing to register no 20h the device responds with an “old” address in the message.
- 2 - after writing to register no 22h the device responds with the new baud rate.
- 3 - the value of the “**mbAc**” parameter is also connected to write to this register, so it is possible to block a writes, but impossible to unblock writes via RS-485 interface. The unblocking of the writes is possible from menu level only.
- 4 - if often changing of display brightness is required, writing to register 31h is recommended. Contents of this register is not stored while power off, and after power on parameter set via MENU is used for display brightness (register 2Dh)

9.2. TRANSMISSION ERRORS DESCRIPTION

If an error occurs while write or read of single register, then the device sends an error code according to Modbus RTU specifications.

Error codes:

- 01h** - illegal function (only functions 03h, 06h and 10h are available),
- 02h** - illegal register address
- 03h** - illegal data value
- 08h** - no write permission (see: “**mbAc**” parameter)

9.3. EXAMPLES OF QUERY/ANSWER FRAMES

Examples apply for device with address 1. All values are represent hexadecimal.

Field description:

- ADDR** Device address on modbus network
- FUNC** Function code
- REG H,L** Starting address (address of first register to read/write, Hi and Lo byte)
- COUNT H,L** No. of registers to read/write (Hi and Lo byte)
- BYTE C** Data byte count in answer frame
- DATA H,L** Data byte (Hi and Lo byte)
- CRC L,H** CRC error check (Hi and Lo byte)

1. Read of device ID code

ADDR	FUNC	REG H,L		COUNT H,L		CRC L,H	
01	03	00	21	00	01	D4	00

The answer:

ADDR	FUNC	BYTE C	DATA H,L		CRC L,H	
01	03	02	20	5A	21	BF

DATA - identification code (205Ah)

2. Change of the device address from 1 to 2 (write to reg. 20h)

ADDR	FUNC	REG H,L		DATA H,L		CRC L,H	
01	06	00	20	00	02	09	C1

DATA H - 0

DATA L - new device address (2)

The answer (the same as the message):

ADDR	FUNC	REG H,L		DATA H,L		CRC L,H	
01	06	00	20	00	02	09	C1

3. Simultaneous writing to year, month and day registers (multi register write using modbus function 10h)

ADDR	FUNC	REG H,L		COUNT H,L		BYTE C
01	10	00	11	00	03	06

And next bytes of frame:

DATA H1,L1		DATA H2,L2		DATA H3,L3		CRC L,H	
07	D5	00	05	00	17	EA	BA

This write causes by setting the date to : 23th of may 2005

Device's answer :

ADDR	FUNC	REG H,L		COUNT H,L		CRC L,H	
01	10	00	01	00	03	D1	C8

4. Try to write improper value to register 22h (baud rate).

ADDR	FUNC	REG H,L		DATA H,L		CRC L,H	
01	06	00	22	00	09	E9	C6

DATA L - DATA L – value exceeds allowable range (from 0 to 7)

The answer (if an error occur):

ADDR	FUNC	ERR	CRC L,H	
01	86	03	02	61



There is no full implementation of the Modbus Protocol in the device. The functions presented above are available only.

10. DEFAULT AND USER'S SETTINGS LIST

<i>Parameter</i>	<i>Description</i>	<i>Default value</i>	<i>User's value</i>	<i>Desc. page</i>
Display parameters				
bri	Display brightness	bri6		19
Periods of readings displaying ("dLy" menu)				
dL c	Period of time displaying	10		19
dL d	Period of date displaying	3		19
dL t	Period of temperature displaying	3		19
dt h	Period of humidity displaying	3		19
Selection of readings ("Func" menu)				
dAtE	Enable/disable of date displaying	on		20
yEAR	Enable/disable of year displaying while date displaying	on		20
thEr	Thermometer displaying function	oFF		20
humi	Enable/disable of humidity displaying	oFF		20
DCF77 signal receiver configuration ("dCF" menu)				
modE	Enable/disable of synchronization with DCF77	oFF		20
diSP	Enable/disable signalisation of DCF module output state	oFF		21
RS 485 interface configuration ("rS" menu)				
Addr	Device address	0		22
bAud	Baud rate	9600		22
mbAC	Permission for modifying unit's parameters through RS485 interface	on		22
rESP	Additional delay of answer transmission	Std		22
Configuration of numerical parameters edition				
Edit	Numerical parameters edit mode	dig		23

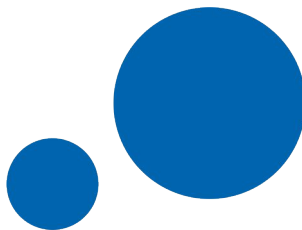

**SIMEX Sp. z o.o.
ul. Wielopole 11
80-556 Gdańsk
Poland**

**tel.: (+48 58) 762-07-77
fax: (+48 58) 762-07-70**

**<http://www.simex.pl>
e-mail: info@simex.pl**