



**RGB Technology<sup>®</sup>**  
MODERN TECHNOLOGIES

# OPERATION AND MAINTENANCE MANUAL

ZB5 clock in Prestige line casing

Product code:

301-21-11	301-21-31
301-21-12	301-21-32
301-21-13	301-21-33
301-21-14	301-21-34
301-21-15	301-21-35
301-21-16	301-21-36



\*Explanatory figure

## Table of content

1	Manufacturer .....	3
2	Specifications .....	3
3	Transport and storage .....	3
4	Device construction .....	3
4.1	Construction of the ZB5 CLOCKS .....	4
4.1.1	List of clock cables .....	4
4.2	Dimensions of the ZB5 device .....	4
4.2.1	Mounting the ZB5 device .....	4
5	Installation of the device .....	5
6	ZB5 application .....	5
6.1	ZB5 configuration .....	5
6.1.1	Configuration of the device through the IR remote .....	5
6.1.2	Configuration of the device through the embedded website - Web panel .....	6
7	Extender module .....	6
8	Description of the extender connectors .....	7
9	Accuracy .....	7
10	Executive relay module .....	7
10.1	Executive relay parameters .....	8
11	Automatic brightness control of the device .....	8
12	Additional options .....	8
12.1	Alternative power supplies .....	8
12.1.1	PoE (Power over Ethernet) .....	8
12.1.2	24VDC .....	8
13	Cooperation between clocks .....	8
13.1	Double-sided device .....	9
13.2	GPS module .....	9
13.3	Temperature probe .....	9
13.4	Audible signalling device .....	9
14	Initial start-up .....	10
15	Disposal and recycling .....	10
15.1	Disposal of the device .....	10
15.2	Disposal of the device .....	10
16	Most common installation errors .....	10

## 1 Manufacturer

RGB Technology Sp. z o. o.  
Tymień 18  
76-035 Tymień  
POLAND

## 2 Specifications

### ZB5 clock

Dimensions of the device (WxHxD) [mm]:	408 x 141 x 42
Display format:	HH:MM:SS
Permissible input voltage range (long-term):	100 ÷ 240 VAC
Permissible input voltage range (short-term):	85 ÷ 264 VAC
Acceptable input voltage frequency range:	47 ÷ 63 Hz
Digit height [mm]:	50
Weight of the device:	1.3kg
Casing tightness rating <sup>1</sup> IP:	66
Average power consumption of the device:	7W
Device operation temperature (ambient):	-25°C ÷ 45°C
Device operation temperature (device surface)	-25°C ÷ 60°C

Available LED colours:

- red
- green
- blue
- yellow
- amber
- white

## 3 Transport and storage

Care should be taken to properly protect the devices so as to eliminate any damage during transport. It is forbidden to transport the devices in a collective package without adequate amortisation - each device must be packed separately and cannot have freedom of movement during transportation.

Due to the protective packing the module should be stored in the temperature not lower than -25°C and not higher than +60°C at the humidity below 99%RH.

## 4 Device construction

ZB5 has a housing made of polycarbonate, which is resistant to UV radiation and has a high mechanical strength. By using the thermo-moulded housing and a rear sealing layer, the device, when properly assembled, meets the IP66 tightness requirements.

<sup>1</sup> Specified on the basis of EN 60529.

## 4.1 Construction of the ZB5 CLOCKS

The figure shows ZB5 clock<sup>2</sup>.

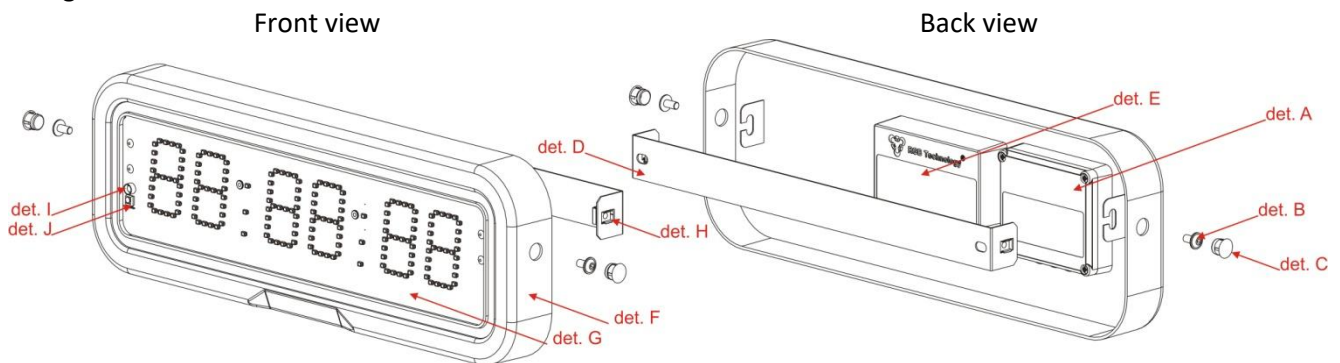

det. A - extender box; det. B - M5x10 screw; det. C - technological hole plug; det. D - mounting bracket; det. E - power supply unit; det. F - Prestige Line casing; det. G - viewfinder; det. H - M5 cage nuts; det. I - lighting sensor; det. J - IR sensor

fig. 1

### 4.1.1 List of clock cables

1. Two-metre power cord (2 x 0.5mm<sup>2</sup>), terminated with power plug,
2. Ten-metre LAN cord, terminated with RJ45 plug. (LAN variant only)

## 4.2 Dimensions of the ZB5 device

All the dimensions shown in the drawings are given in [mm].

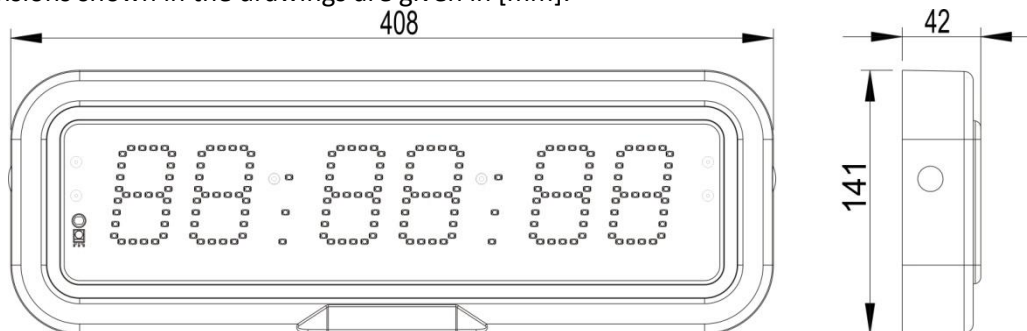

fig. 2

### 4.2.1 Mounting the ZB5 device

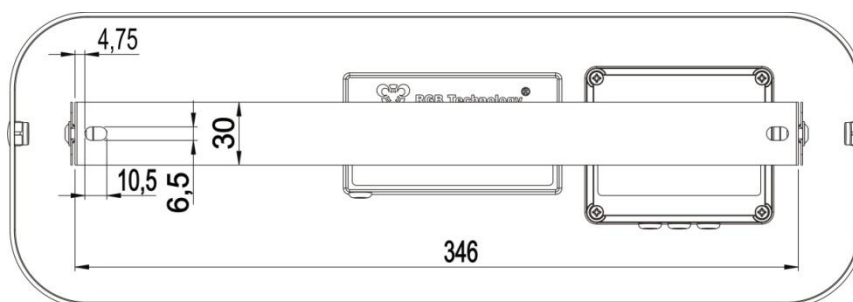

fig. 3

<sup>2</sup> Explanatory figure.

## 5 Installation of the device

Proper installation consists in mounting the device on a flat surface with the leads facing down. Only the correct installation of the device ensures its proper operation and maintaining the device parameters, e.g. casing tightness rating to satisfy the IP code.

### NOTICE!

Before any installation or maintenance operations refer to the manual supplied by the manufacturer. Improper connection to the mains power supply, incautious device installation, or improper use may cause the property damage, loss of health or death from electrical shock! In addition, any failure to follow the manufacturer's instructions may void your warranty.

### NOTICE!

Keep in mind that all the components must be mounted with the leads facing down.

### NOTICE!

It is forbidden to make any additional mounting points or any holes in the device assembly components.

## 6 ZB5 application

The ZB5 device is designed to display time, date and optionally temperature. Additionally the clock enables signalling alarms using an embedded executive relay and could be used as a time standard for other devices. For the proper operation of the device, it should be correctly configured.

### 6.1 ZB5 configuration

The configuration process consists in personalising the device by a user. The device is configured using IR remote or LAN interface, depending on device variant.

#### 6.1.1 Configuration of the device through the IR remote

The basic configuration method is by means of the remote control through the user menu. fig. 4 shows the remote control, along with the explanation of the function of each button. You enter the user menu using the **MENU** button. You navigate and modify the respective parameters using the buttons **↑**, **↓**, **←** and **→**.

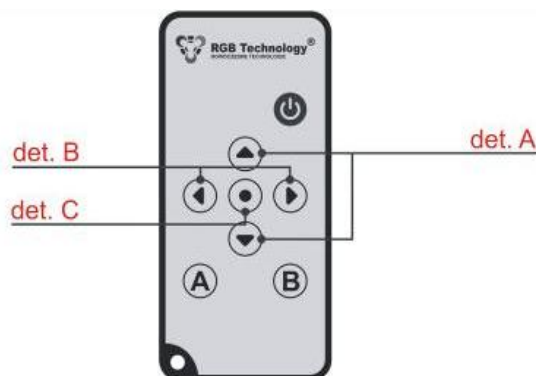

det. A – Change the parameter (VALUE PLUS/VALUE MINUS) det. B – move to the next position (PREVIOUS/NEXT);  
 det. C – „MENU” button

fig. 4

Main menu structure:

Menu position	Function description
F1	Manual setting of the time and the date
F2	Configuration of the presented parameters
F3	Configuration of the date format
F4	Configuration of the time synchronization <sup>3</sup>
F5	Configuration of the display brightness
F6	Configuration of the alarms
F7	Configuration of the ECO mode
F8	Configuration of the display font
F9	Restoring the default settings
F10	Configuration of temperature offset
F11	Configuration of display synchronization
F12	Displaying information about the signal strength or disconnection of the GPS module
F13	Regional settings, such as location, time zones, daylight saving time/standard time
F14	Stopwatch function / timer counting up / timer counting down

### 6.1.2 Configuration of the device through the embedded website - Web panel

To connect with the clock, first you should configure the network card of the computer to which it is connected. The proper configuration of the network card can be downloaded from <http://rgbtechnology.pl/soft/>. Having configured the network connection correctly, you can, through a Web browser, connect with the embedded website (Web panel), where you can personalise the device. On the embedded clock website, you may use the following tabs:

- TIME -> tab allowing you to configure the parameters connected with time;
- DISPLAY -> tab allowing you to configure the parameters connected with the device display;
- ALARMS -> tab allowing you to configure the parameters connected with alarms (option available in the version with an audible signalling device);
- ADVANCED -> tab allowing you to configure the advanced parameters of the device;
- STATUS -> tab allowing you to read the device status.

The detailed description of the tabs is available in the device operation manual `instr_hardware_037`.

## 7 Extender module

The extender module (fig. 5) enables the operation of peripheral devices and, thanks to a supercapacitor, ensures correct time counting when there is no external power supply

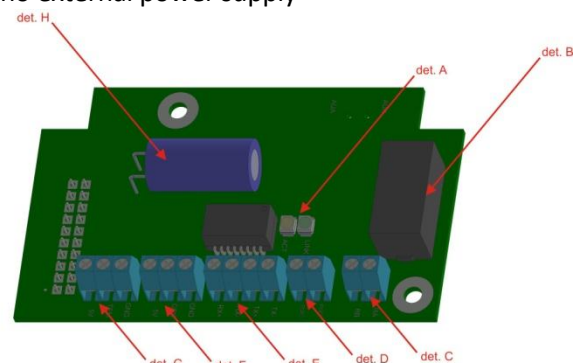
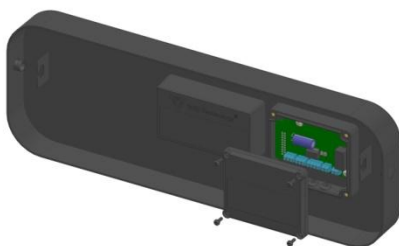

det. A signal LEDs; det. B – relay; det. C – relay connector; det. D – PoE output ; det. E – LAN connector; det. F – GPS connector; det. G – temperature probe connector; det. H – supercapacitor

fig. 5

<sup>3</sup> Option available in the variant equipped with the network synchronizations module or the GPS module.

## 8 Description of the extender connectors

	Symbol	Function	Remarks	Wire colour
STANDARD	RA	Relay (alarm signalling device)	Closing contact, normally open;	brown ("return")
	RB			blue ("input")
	GPS	GPS module signal	Cooperates with GPS GM-2	orange
	TEM	Temp. probe signal	–	orange
	5V	Power supply for external modules	Power supply for GPS and temp. probe	red
	GND	Mass of the system	–	black
OPTIONAL	TX+	Ethernet	Pin no. 1 plugs RJ-45	orange-white
	TX-		Pin no. 2 plugs RJ-45	orange
	RX+		Pin no. 3 plugs RJ-45	green-white
	RX-		Pin no. 6 plugs RJ-45	green
	POE1	PoE output lines (Power over Ethernet)	IEEE 802.3at Mode A (Endspan)	red
	POE2			black

Table 1

## 9 Accuracy

In standard the accuracy of the device is based on the built-in RTC quartz crystal oscillator. Declared accuracy with a stable power supply and at the operating temperature of 25°C is +/- 1 minute per month.

To eliminate the RTC clock aberration (loss or gain) and increase accuracy, the device can be synchronized with the alternative time standard. Declared in Table 2 aberration in regard to the time standard is non-recurring and non-cumulative.

Time standard	Communication method	Aberration in regard to the time standard
NTP time server	LAN	depends on server, maximum: +/- 20 ms
GPS	GPS GM-2 module	strong and stable signal: +/- 20 ms poor signal: +/- 100 ms
Master clock	LAN	depends on accuracy of the master clock

Table 2

Notice! During the first time synchronization or resume (e.g. after signal loss), the device recovers full accuracy after 40 to 80s.

## 10 Executive relay module

The device is equipped with an embedded executive relay, which enables signalling up to 30 alarms. The duration of each alarm can be set in a time interval between 1 and 59 seconds. Sample applications:

- 1) Activating an acoustic signalling device for industrial applications<sup>4</sup>, signalling, for example, a break or a shift rotation in an industrial plant;
- 2) Activating a school bell;
- 3) Giving a time signal to separate systems or devices.

<sup>4</sup> Optionally, an audible signalling device is available.

## 10.1 Executive relay parameters

Embedded executive relay parameters	
Types of contacts	NO (normal open)
Maximum resistive load	5A
Maximum inductive load	2A
Maximum applied voltage	250VAC/30VDC

Table 3

There is a possibility to connect a different signalling device (e.g. visual or visual-acoustic) to the relay connector. In such case, be careful not to exceed the relay electric parameters.

## 11 Automatic brightness control of the device

In the standard version, a lighting sensor is included. The device, in response to the ambient lighting conditions, adjusts the brightness of the clock display.

## 12 Additional options

### 12.1 Alternative power supplies

#### 12.1.1 PoE (Power over Ethernet)

Optionally, the clock can be powered-up through the LAN connector (PoE). Choosing this power supply option requires using a power supply device meeting the IEEE 802.3at standard.

#### 12.1.2 24VDC

Optionally the clock can be powered-up through the 24VDC power supply.

Notice! Choosing the power supply option is final. It's impossible to adapt the device for another power method.

## 13 Cooperation between clocks

The device with LAN support has an option to cooperate with other clocks through the network. In this system the Master clock is a time standard for Slave clocks. Also it controls the displayed information. Thanks to that all the clocks show exactly the same time and type of information e.g. display the temperature simultaneously. The cooperation is possible between different models of RGB Technology clocks.

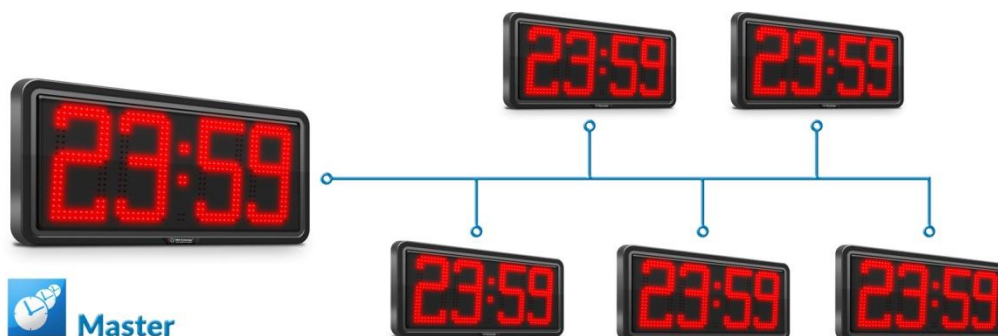



## 13.1 Double-sided device

On special request also double-sided devices are offered. Various mounting and power supply options are available. For double-sided variants it is possible to choose the same additional options as for the single-sided clocks. For detailed information please contact the distributor.



fig. 6

## 13.2 GPS module

Optionally, the device may be equipped with an external GPS module. The properly configured clock equipped with the GPS module can synchronise the time with a satellite. The standard cable length is 10m. The detailed description of the module is available in the DTR documentation of the GPS module.



fig. 7

## 13.3 Temperature probe

The optional temperature probe is available with two versions of a signal cable length 0.5m and 2m. The probe enables measuring and displaying temperature in °C (Celsius) or °F (Fahrenheit). The detailed description of the temperature probe is available in the DTR documentation according to the catalogue index number.



fig. 8

## 13.4 Audible signalling device

Optionally, the device is equipped with an audible signalling device. The user may choose one of two signalling device versions:

- 1) volume of the audio signal at the level of 88dB;
- 2) volume of the audio signal at the level of 108dB.

The standard cable length is 10m

The detailed description of the signalling device is available in the DTR documentation according to the catalogue index number.

## 14 Initial start-up

Step 1: Connect the device to 230V power supply,

Step 2: Properly connected system should display pre-set (current) time and date.

## 15 Disposal and recycling

### 15.1 Disposal of the device

The packaging materials must be segregated , then recycled in accordance with local regulations for waste disposal regulations.

### 15.2 Disposal of the device

The device can not be disposed with regular household waste!

According to Directive 2002 / 96 / EC ( WEEE ) , when repair is not economically reasonable, user is obligated to hand over damaged or destroyed device to an appropriate disposal facility .



## 16 Most common installation errors

1. Device installed contrary to the instructions,
2. Drilling additional holes in the casing.
3. No plugs in unused holes of the extender box.